



SGM8041

710nA, Single Rail-to-Rail I/O Operational Amplifier

GENERAL DESCRIPTION

The SGM8041 is a single, high precision operational amplifier which can operate from 1.4V to 5.5V single supply, while consuming only 710nA quiescent current. It provides rail-to-rail input and output operation. Therefore, the SGM8041 is suitable for use in portable instrumentation and battery-powered systems.

The SGM8041 is unity-gain stable, and features a 14.5kHz gain-bandwidth product. It is designed to provide optimal performance in low frequency systems, when monitoring battery current and conditioning sensor signal.

The SGM8041 is available in Green SOT-23-5, SOIC-8 and MSOP-8 packages. It operates over an ambient temperature range of -40°C to +85°C.

FEATURES

- **Low Quiescent Current: 710nA (TYP)**
- **Rail-to-Rail Input and Output**
- **Gain-Bandwidth Product: 14.5kHz at $V_S = 5V$ (TYP)**
- **Wide Supply Voltage Range: 1.4V to 5.5V**
- **Unity-Gain Stable**
- **-40°C to +85°C Operating Temperature Range**
- **Available in Green SOT-23-5, SOIC-8 and MSOP-8 Packages**

APPLICATIONS

Temperature Measurements
Toll Booth Tags
Battery-Powered Systems
Wearable Products

PACKAGE/ORDERING INFORMATION

MODEL	PACKAGE DESCRIPTION	SPECIFIED TEMPERATURE RANGE	ORDERING NUMBER	PACKAGE MARKING	PACKING OPTION
SGM8041	SOT-23-5	-40°C to +85°C	SGM8041YN5G/TR	S24XX	Tape and Reel, 3000
	SOIC-8	-40°C to +85°C	SGM8041YS8G/TR	SGM8041YS8 XXXXX	Tape and Reel, 2500
	MSOP-8	-40°C to +85°C	SGM8041YMS8G/TR	SGM8041 YMS8 XXXXX	Tape and Reel, 3000

MARKING INFORMATION

NOTE: XX = Date Code. XXXXX = Date Code and Vendor Code.

SOT-23-5

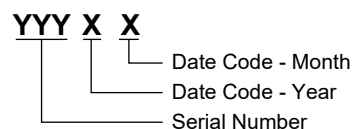

SOIC-8/MSOP-8

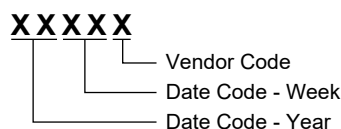

Green (RoHS & HSF): SG Micro Corp defines "Green" to mean Pb-Free (RoHS compatible) and free of halogen substances. If you have additional comments or questions, please contact your SGMICRO representative directly.

ABSOLUTE MAXIMUM RATINGS

- Supply Voltage.....6V
- Analog Inputs (+IN, -IN)..... (-V_S) - 0.1V to (+V_S) + 0.1V
- Differential Input Voltage..... |(-V_S) - (+V_S)|
- Junction Temperature.....+150°C
- Storage Temperature Range.....-65°C to +150°C
- Lead Temperature (Soldering, 10s).....+260°C
- ESD Susceptibility
- HBM.....3000V
- MM.....300V

RECOMMENDED OPERATING CONDITIONS

- Operating Temperature Range.....-40°C to +85°C

OVERSTRESS CAUTION

Stresses beyond those listed in Absolute Maximum Ratings may cause permanent damage to the device. Exposure to absolute maximum rating conditions for extended periods may affect reliability. Functional operation of the device at any

conditions beyond those indicated in the Recommended Operating Conditions section is not implied.

ESD SENSITIVITY CAUTION

This integrated circuit can be damaged if ESD protections are not considered carefully. SGMICRO recommends that all integrated circuits be handled with appropriate precautions. Failure to observe proper handling and installation procedures can cause damage. ESD damage can range from subtle performance degradation to complete device failure. Precision integrated circuits may be more susceptible to damage because even small parametric changes could cause the device not to meet the published specifications.

DISCLAIMER

SG Micro Corp reserves the right to make any change in circuit design, or specifications without prior notice.

PIN CONFIGURATIONS

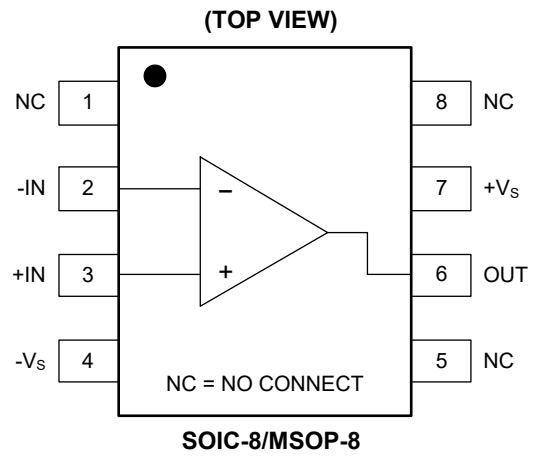
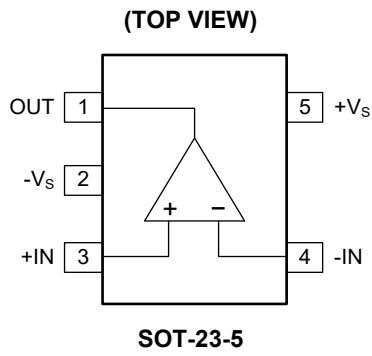

ELECTRICAL CHARACTERISTICS(At $T_A = +25^\circ\text{C}$, $+V_S = 1.4\text{V}$ to 5.0V , $-V_S = 0\text{V}$, $V_{CM} = +V_S/2$, $V_{OUT} = +V_S/2$ and $R_L = 1\text{M}\Omega$ to $+V_S/2$, unless otherwise noted.)

PARAMETER	SYMBOL	CONDITIONS	MIN	TYP	MAX	UNITS
DC Electrical Characteristics						
Input Offset Voltage	V_{OS}	$V_{CM} = +V_S/2$		0.4	2.5	mV
Input Offset Voltage Drift	$\Delta V_{OS}/\Delta T$	$V_{CM} = +V_S/2$, $-40^\circ\text{C} \leq T_A \leq +85^\circ\text{C}$		2.5		$\mu\text{V}/^\circ\text{C}$
Power Supply Rejection Ratio	PSRR	$+V_S = 1.4\text{V}$ to 5.5V	74	80		dB
Common Mode Input Range	V_{CMR}		$(-V_S) - 0.1$		$(+V_S) + 0.1$	V
Common Mode Rejection Ratio	CMRR	$+V_S = 5.0\text{V}$, $V_{CM} = -0.1\text{V}$ to 5.1V	67	84		dB
		$+V_S = 5.0\text{V}$, $V_{CM} = 2.5\text{V}$ to 5.1V	70	83		
		$+V_S = 5.0\text{V}$, $V_{CM} = -0.1\text{V}$ to 2.5V	66	78		
Large-Signal Voltage Gain	A_{VO}	$+V_S = 1.4\text{V}$, $R_L = 50\text{k}\Omega$, $V_{OUT} = (+V_S) - 0.1\text{V}$	72	80		dB
		$+V_S = 2.5\text{V}$, $R_L = 50\text{k}\Omega$, $V_{OUT} = (+V_S) - 0.1\text{V}$		88		
		$+V_S = 5.0\text{V}$, $R_L = 50\text{k}\Omega$, $V_{OUT} = (+V_S) - 0.1\text{V}$	76	93		
Input Bias Current	I_B			1		pA
Input Offset Current	I_{OS}			1		pA
Maximum Output Voltage Swing	V_{OH}	$+V_S = 1.4\text{V}$, $R_L = 50\text{k}\Omega$	1.390	1.395		V
		$+V_S = 2.5\text{V}$, $R_L = 50\text{k}\Omega$		2.497		
		$+V_S = 5.0\text{V}$, $R_L = 50\text{k}\Omega$	4.990	4.997		
	V_{OL}	$+V_S = 1.4\text{V}$, $R_L = 50\text{k}\Omega$		4.5	10	mV
		$+V_S = 2.5\text{V}$, $R_L = 50\text{k}\Omega$		3.1		
		$+V_S = 5.0\text{V}$, $R_L = 50\text{k}\Omega$		3.5	10	
Output Short-Circuit Current	I_{SC}	$+V_S = 2.5\text{V}$		5.5		mA
		$+V_S = 5.0\text{V}$	22	24		
Supply Voltage	V_{CC}		1.4		5.5	V
Quiescent Current	I_Q	$+V_S = 1.4\text{V}$		600		nA
		$+V_S = 2.5\text{V}$		660		
		$+V_S = 5.0\text{V}$		710	1500	

ELECTRICAL CHARACTERISTICS (continued)

(At $T_A = +25^\circ\text{C}$, $+V_S = 1.4\text{V}$ to 5.0V , $-V_S = 0\text{V}$, $V_{CM} = +V_S/2$, $V_{OUT} = +V_S/2$ and $R_L = 1\text{M}\Omega$ to $+V_S/2$, $C_L = 60\text{pF}$, unless otherwise noted.)

PARAMETER	SYMBOL	CONDITIONS	MIN	TYP	MAX	UNITS
AC Electrical Characteristics						
Gain-Bandwidth Product	GBP	$+V_S = 1.4\text{V}$		13.5		kHz
		$+V_S = 2.5\text{V}$		14.3		
		$+V_S = 5.0\text{V}$		14.5		
Slew Rate	SR	$+V_S = 1.4\text{V}$, $V_{OUT} = 1\text{V Step}$		3.0		V/ms
		$+V_S = 2.5\text{V}$, $V_{OUT} = 1\text{V Step}$		3.0		
		$+V_S = 5.0\text{V}$, $V_{OUT} = 2\text{V Step}$		3.3		
Phase Margin	PM	$+V_S = 1.4\text{V}$ to 5.5V		60		$^\circ$
Input Voltage Noise		$+V_S = 1.4\text{V}$, $f = 0.1\text{Hz}$ to 10Hz		3.7		μV_{P-P}
		$+V_S = 2.5\text{V}$, $f = 0.1\text{Hz}$ to 10Hz		3.5		
		$+V_S = 5.0\text{V}$, $f = 0.1\text{Hz}$ to 10Hz		3.4		
Input Voltage Noise Density	e_n	$+V_S = 1.4\text{V}$, $f = 1\text{kHz}$		143		$\text{nV}/\sqrt{\text{Hz}}$
		$+V_S = 2.5\text{V}$, $f = 1\text{kHz}$		144		
		$+V_S = 5.0\text{V}$, $f = 1\text{kHz}$		135		

TYPICAL PERFORMANCE CHARACTERISTICS

At $T_A = +25^\circ\text{C}$, $+V_S = 1.4\text{V to } 5.0\text{V}$, $-V_S = 0\text{V}$, $V_{CM} = +V_S/2$, $V_{OUT} = +V_S/2$ and $R_L = 1\text{M}\Omega$ to $+V_S/2$, $C_L = 60\text{pF}$, unless otherwise noted.

Large Signal Inverting Pulse Response

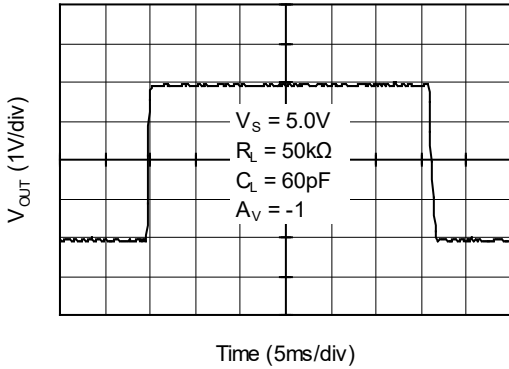

Large Signal Non-Inverting Pulse Response

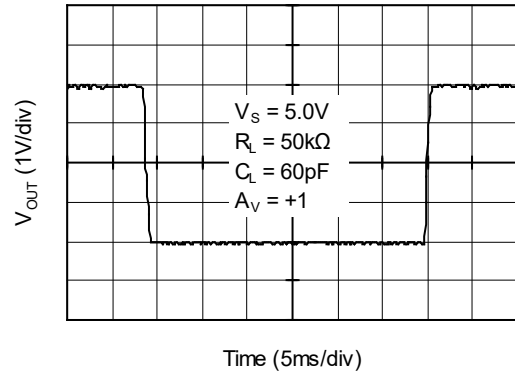

Small Signal Inverting Pulse Response

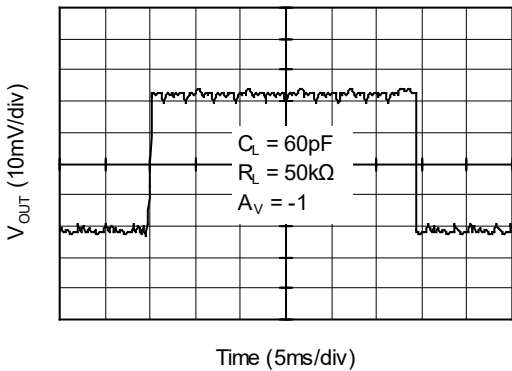

Small Signal Non-Inverting Pulse Response

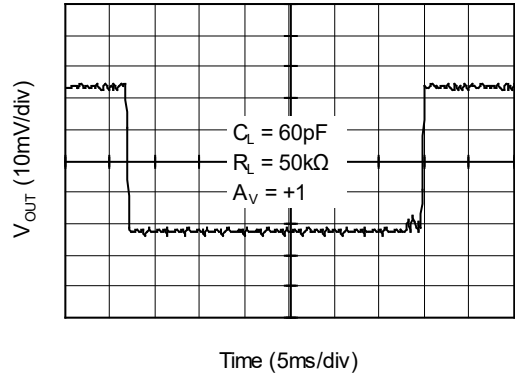

No Phase Reversal

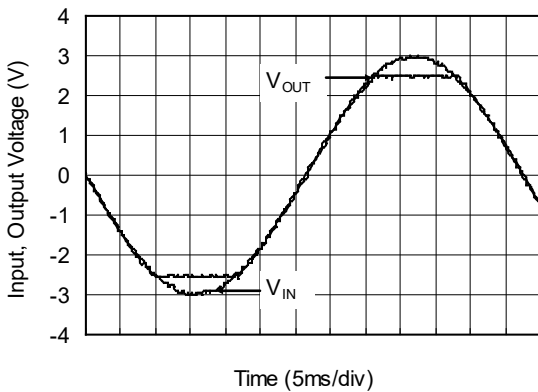

Slew Rate vs. Temperature

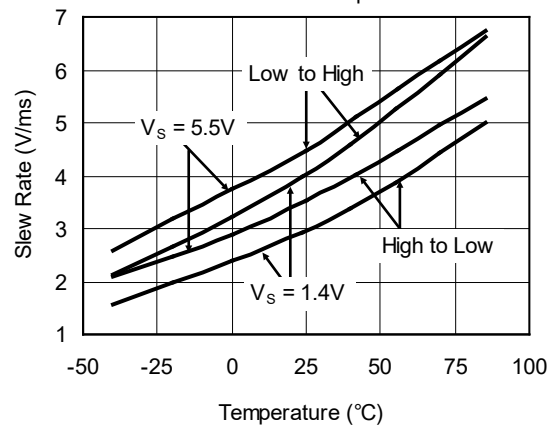

TYPICAL PERFORMANCE CHARACTERISTICS (continued)

At $T_A = +25^\circ\text{C}$, $+V_S = 1.4\text{V to } 5.0\text{V}$, $-V_S = 0\text{V}$, $V_{CM} = +V_S/2$, $V_{OUT} = +V_S/2$ and $R_L = 1\text{M}\Omega$ to $+V_S/2$, $C_L = 60\text{pF}$, unless otherwise noted.

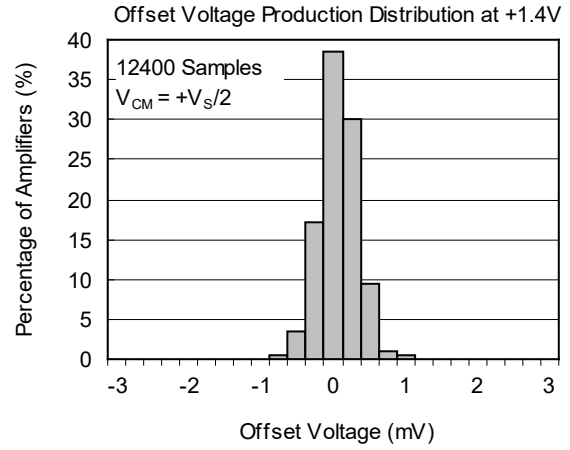
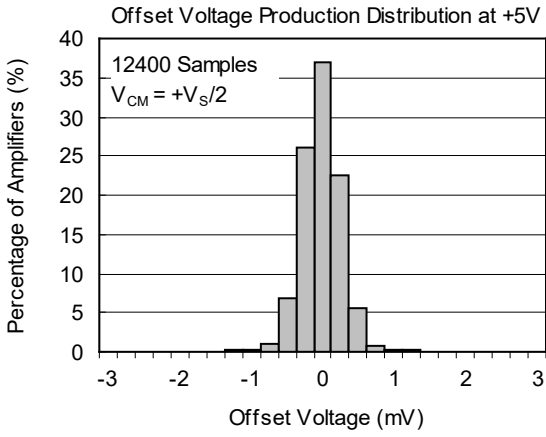

REVISION HISTORY

NOTE: Page numbers for previous revisions may differ from page numbers in the current version.

	Page
<hr/>	
JUNE 2017 – REV.A.2 to REV.A.3	
Added Application Information section	6
<hr/>	
JANUARY 2013 – REV.A.1 to REV.A.2	Page
Added Tape and Reel Information section	11~12
<hr/>	
MAY 2011 – REV.A to REV.A.1	Page
Updated Package Description	All
<hr/>	
Changes from Original (APRIL 2010) to REV.A	Page
Changed from product preview to production data	All
<hr/>	

PACKAGE INFORMATION

PACKAGE OUTLINE DIMENSIONS

SOT-23-5

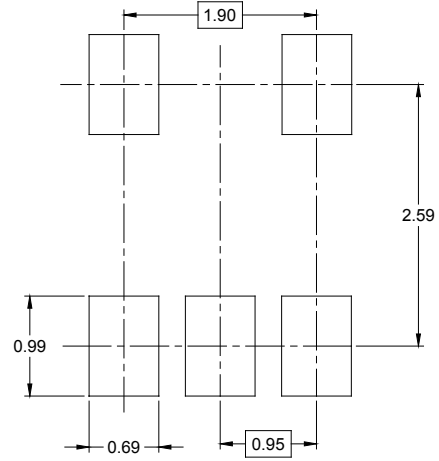
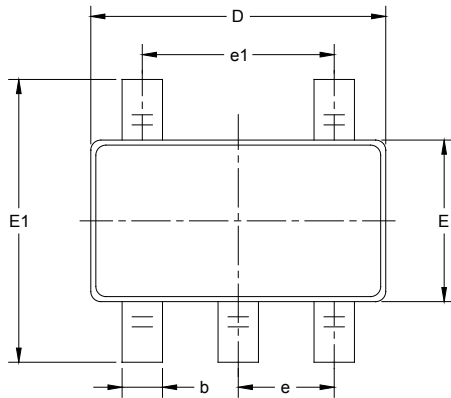

RECOMMENDED LAND PATTERN (Unit: mm)

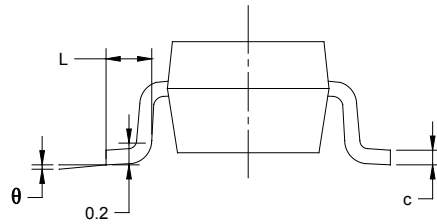
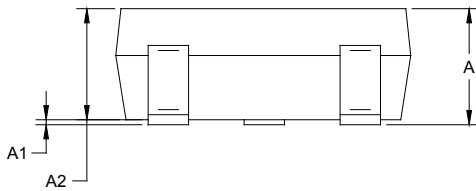

Symbol	Dimensions In Millimeters		Dimensions In Inches	
	MIN	MAX	MIN	MAX
A	1.050	1.250	0.041	0.049
A1	0.000	0.100	0.000	0.004
A2	1.050	1.150	0.041	0.045
b	0.300	0.500	0.012	0.020
c	0.100	0.200	0.004	0.008
D	2.820	3.020	0.111	0.119
E	1.500	1.700	0.059	0.067
E1	2.650	2.950	0.104	0.116
e	0.950 BSC		0.037 BSC	
e1	1.900 BSC		0.075 BSC	
L	0.300	0.600	0.012	0.024
θ	0°	8°	0°	8°

PACKAGE OUTLINE DIMENSIONS

SOIC-8

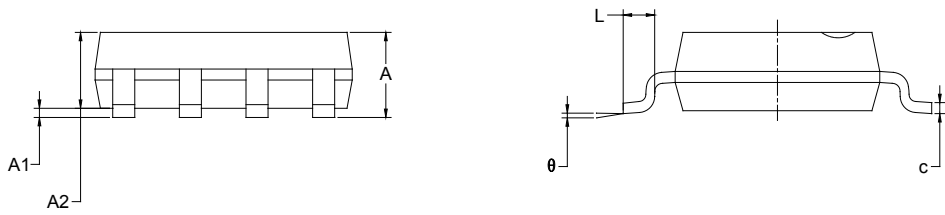
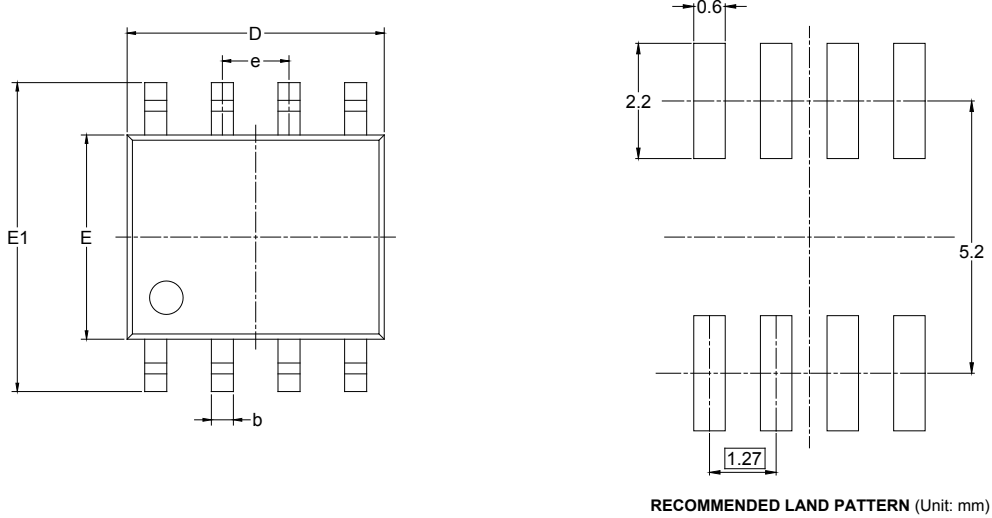

Symbol	Dimensions In Millimeters		Dimensions In Inches	
	MIN	MAX	MIN	MAX
A	1.350	1.750	0.053	0.069
A1	0.100	0.250	0.004	0.010
A2	1.350	1.550	0.053	0.061
b	0.330	0.510	0.013	0.020
c	0.170	0.250	0.006	0.010
D	4.700	5.100	0.185	0.200
E	3.800	4.000	0.150	0.157
E1	5.800	6.200	0.228	0.244
e	1.27 BSC		0.050 BSC	
L	0.400	1.270	0.016	0.050
θ	0°	8°	0°	8°

PACKAGE OUTLINE DIMENSIONS

MSOP-8

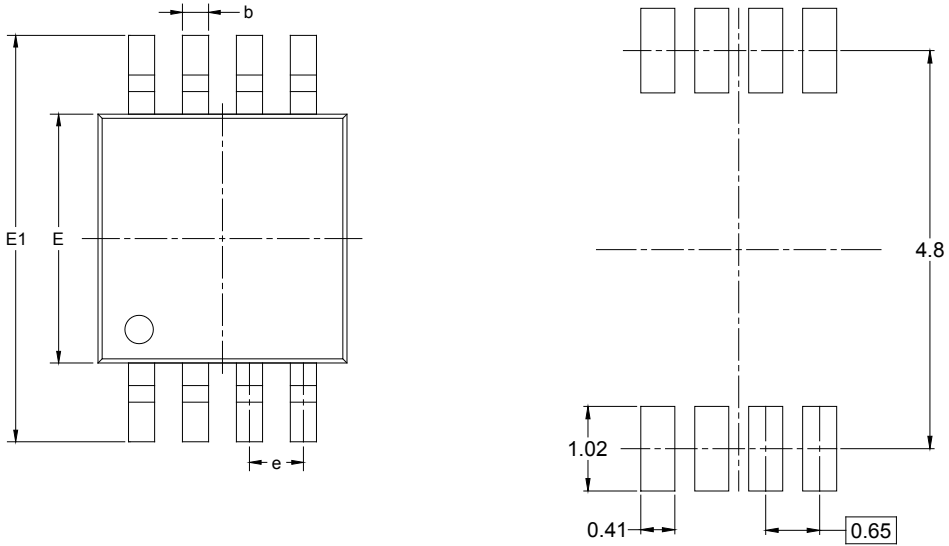

RECOMMENDED LAND PATTERN (Unit: mm)

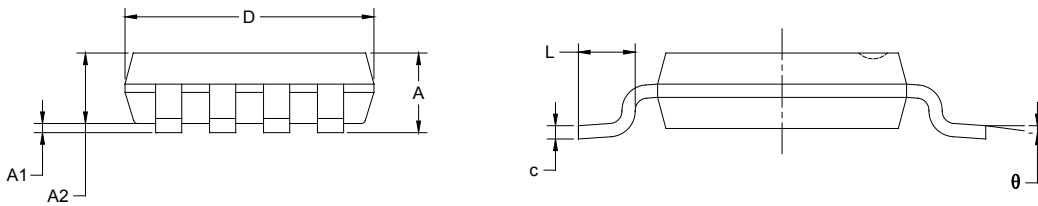

Symbol	Dimensions In Millimeters		Dimensions In Inches	
	MIN	MAX	MIN	MAX
A	0.820	1.100	0.032	0.043
A1	0.020	0.150	0.001	0.006
A2	0.750	0.950	0.030	0.037
b	0.250	0.380	0.010	0.015
c	0.090	0.230	0.004	0.009
D	2.900	3.100	0.114	0.122
E	2.900	3.100	0.114	0.122
E1	4.750	5.050	0.187	0.199
e	0.650 BSC		0.026 BSC	
L	0.400	0.800	0.016	0.031
θ	0°	6°	0°	6°

TAPE AND REEL INFORMATION

REEL DIMENSIONS

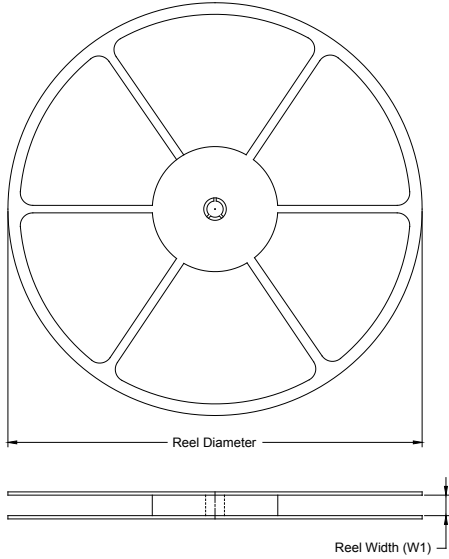

TAPE DIMENSIONS

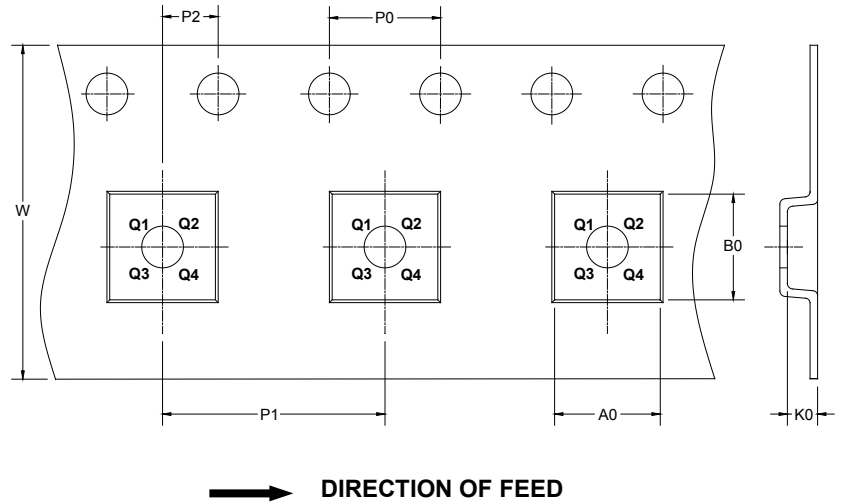

NOTE: The picture is only for reference. Please make the object as the standard.

KEY PARAMETER LIST OF TAPE AND REEL

Package Type	Reel Diameter	Reel Width W1 (mm)	A0 (mm)	B0 (mm)	K0 (mm)	P0 (mm)	P1 (mm)	P2 (mm)	W (mm)	Pin1 Quadrant
SOT-23-5	7"	9.5	3.20	3.20	1.40	4.0	4.0	2.0	8.0	Q3
SOIC-8	13"	12.4	6.40	5.40	2.10	4.0	8.0	2.0	12.0	Q1
MSOP-8	13"	12.4	5.20	3.30	1.50	4.0	8.0	2.0	12.0	Q1

DD0001

PACKAGE INFORMATION

CARTON BOX DIMENSIONS



NOTE: The picture is only for reference. Please make the object as the standard.

KEY PARAMETER LIST OF CARTON BOX

Reel Type	Length (mm)	Width (mm)	Height (mm)	Pizza/Carton
7" (Option)	368	227	224	8
7"	442	410	224	18
13"	386	280	370	5

DD0002