

GENERAL DESCRIPTION

The SGM61330xQ is internally compensated, synchronous Buck converter with a wide 3.8V to 36V input voltage range and 3A output current capability. This device can be easily used in various automotive applications powered from unregulated sources. Easy compensation and cycle-by-cycle current limit are obtained by peak current mode control. With 28 μ A (TYP) quiescent current and ultra-low 2 μ A (TYP) shutdown current, it is well suited for battery powered systems to prolong battery life. Internal compensation allows quick and low component count design.

The SGM61330xQ can operate at fixed frequency with moderate or heavy load condition. In light load condition, it enters in the pulse frequency modulation (PFM) mode to improve high efficiency.

The EN employs an enable divider to establish a precision threshold that simplifies UVLO adjustment, device on/off control and power sequencing. Thermal shutdown and output short-circuit protection (hiccup mode) are also provided.

The device is AEC-Q100 qualified (Automotive Electronics Council (AEC) standard Q100 Grade 1) and it is suitable for automotive applications.

The SGM61330xQ is available in a Green TQFN-2 \times 3-12BL package.

SIMPLIFIED SCHEMATICS

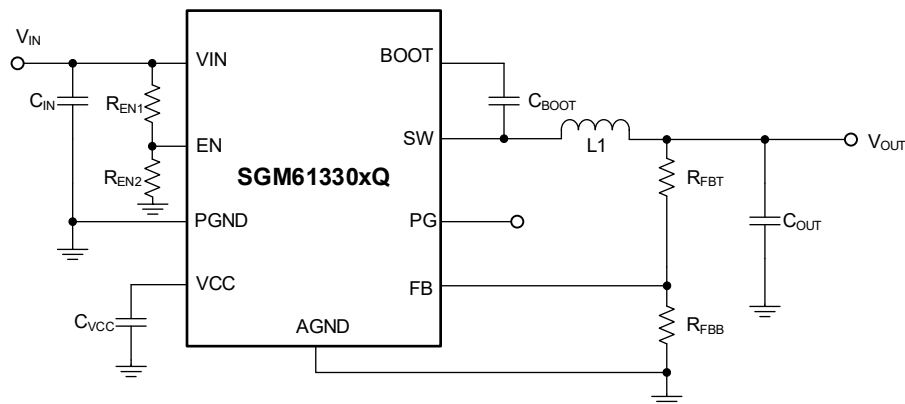

Figure 1. Simplified Schematics

FEATURES

- **AEC-Q100 Qualified for Automotive Applications Device Temperature Grade 1**
 $T_A = -40^{\circ}\text{C}$ to $+125^{\circ}\text{C}$
- **Wide 3.8V to 36V Input Voltage Range**
- **Up to 3A Continuous Output Current**
- **1V to 24V Output Voltage Range**
- **Fixed Switching Frequency**
 - ◆ **SGM61330AQ: 400kHz**
 - ◆ **SGM61330CQ: 2.1MHz**
- **Power-Good Flag and Precision Enable**
- **Integrated $R_{\text{DS(on)}}$ Switches: 65m Ω /42m Ω (TYP)**
- **PFM for High Efficiency at Light Load Condition**
- **Ultra-Low Shutdown Current: 2 μ A (TYP)**
- **Low Quiescent Current: 28 μ A (TYP)**
- **Peak Current Mode Control**
- **Cycle-by-Cycle Current Limit**
- **4ms (TYP) Internal Soft-Start Time**
- **Available in a Green TQFN-2 \times 3-12BL Package**

APPLICATIONS

- Automotive Applications
- Telecom and Datacom Systems
- General Purpose Wide V_{IN} Regulation

PACKAGE/ORDERING INFORMATION

MODEL	PACKAGE DESCRIPTION	SPECIFIED TEMPERATURE RANGE	ORDERING NUMBER	PACKAGE MARKING	PACKING OPTION
SGM61330AQ	TQFN-2×3-12BL	-40°C to +125°C	SGM61330AQTUK12G/TR	0KUUK XXXXX	Tape and Reel, 3000
SGM61330CQ	TQFN-2×3-12BL	-40°C to +125°C	SGM61330CQTUK12G/TR	0KVUK XXXXX	Tape and Reel, 3000

MARKING INFORMATION

NOTE: XXXXX = Date Code, Trace Code and Vendor Code.

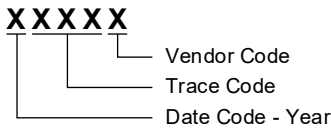

Green (RoHS & HSF): SG Micro Corp defines "Green" to mean Pb-Free (RoHS compatible) and free of halogen substances. If you have additional comments or questions, please contact your SGMICRO representative directly.

ABSOLUTE MAXIMUM RATINGS

- Input Voltage Range
 - VIN to PGND -0.3V to 38V
 - EN to AGND -0.3V to VIN + 0.3V
 - EN to AGND (Less than 10ns Transients).....
 --5V to VIN + 0.3V
 - FB to AGND..... -0.3V to 5V
 - AGND to PGND -0.3V to 0.3V
- Output Voltage Range
 - SW to PGND.....-0.3V to VIN + 0.3V
 - BOOT to SW..... -0.3V to 5.5V
 - VCC to AGND..... -0.3V to 5.5V
 - PG to AGND -0.3V to 24V
- Package Thermal Resistance
 - TQFN-2×3-12BL, θJA 66.3°C/W
 - TQFN-2×3-12BL, θJB 10.8°C/W
 - TQFN-2×3-12BL, θJC 56.2°C/W
- Package Thermal Characterization Parameter
 - TQFN-2×3-12BL, ψJT..... 0.85°C/W
 - TQFN-2×3-12BL, ψJB..... 11.2°C/W
- Junction Temperature.....+150°C
- Storage Temperature Range -65°C to +150°C
- Lead Temperature (Soldering, 10s).....+260°C
- ESD Susceptibility ^{(1) (2)}
- HBM.....±3000V
- CDM ±1000V

NOTES:

1. For human body model (HBM), all pins comply with ANSI/ESDA/JEDEC JS-001 specifications.
2. For charged device model (CDM), all pins comply with ANSI/ESDA/JEDEC JS-002 specifications.

RECOMMENDED OPERATING CONDITIONS

- Input Voltage Range
 - VIN to PGND 3.8V to 36V
 - EN to AGND 0V to 36V
 - FB to AGND -0.3V to 1.2V
 - PG to AGND..... 0V to 18V
- Output Voltage Range..... 1V to 24V
- Output Current Range 0A to 3A
- Operating Junction Temperature Range -40°C to +125°C

OVERSTRESS CAUTION

Stresses beyond those listed in Absolute Maximum Ratings may cause permanent damage to the device. Exposure to absolute maximum rating conditions for extended periods may affect reliability. Functional operation of the device at any conditions beyond those indicated in the Recommended Operating Conditions section is not implied.

ESD SENSITIVITY CAUTION

This integrated circuit can be damaged if ESD protections are not considered carefully. SGMICRO recommends that all integrated circuits be handled with appropriate precautions. Failure to observe proper handling and installation procedures can cause damage. ESD damage can range from subtle performance degradation to complete device failure. Precision integrated circuits may be more susceptible to damage because even small parametric changes could cause the device not to meet the published specifications.

DISCLAIMER

SG Micro Corp reserves the right to make any change in circuit design, or specifications without prior notice.

PIN CONFIGURATION

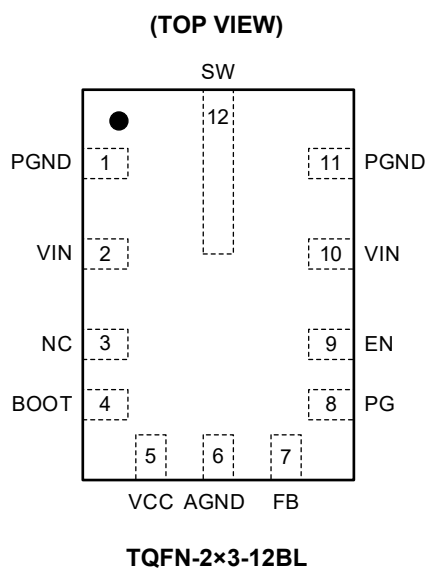

PIN DESCRIPTION

PIN	NAME	TYPE ⁽¹⁾	FUNCTION
1, 11	PGND	G	Power Ground. It is internally connected to converter return. Returns of the C_{IN} and C_{OUT} capacitors should be connected close to this pin. Connect to system ground and AGND together.
2, 10	VIN	P	Power Supply Input Pin. Connect C_{IN} as close as possible between this pin and PGND pin.
3	NC	-	Connect the SW pin to NC on the PCB. This simplifies the connection from the C_{BOOT} capacitor to the SW pin. This pin has no internal connection to the regulator.
4	BOOT	P	Bootstrap Input. Bootstrap supply for high-side driver. Connect a 100nF ceramic capacitor between BOOT and SW pins.
5	VCC	P	LDO (Internal Bias) Output. This pin is provided for bypassing to AGND only. Never load VCC.
6	AGND	G	Analog Ground. Reference for internal analog signals and logic. Connect it to system ground.
7	FB	A	Feedback Input. Connect the midpoint of the feedback resistor divider.
8	PG	A	Open-Drain Power-Good Flag Output. Connect to suitable voltage supply through a current limiting resistor. High = power ok, low = power bad. Flag pulls low when EN = low. Can be left open when not used.
9	EN	A	Active-High Enable Pin. Do not float.
12	SW	P	Switching Node Output. Switching node of the internal synchronous Buck converter with N-MOSFET switches. Connect to the output inductor and bootstrap capacitor.

NOTE: 1. A = analog, P = power, G = ground.

ELECTRICAL CHARACTERISTICS(V_{IN} = 12V, T_J = -40°C to +125°C, typical values are at T_J = +25°C, unless otherwise noted.)

PARAMETER	SYMBOL	CONDITIONS	MIN	TYP	MAX	UNITS
Power Supply						
Input Voltage Range	V _{IN}		3.8		36	V
Input UVLO Rising Threshold	V _{IN_UVLO_H}	Rising threshold		3.65	3.8	V
Input UVLO Falling Threshold	V _{IN_UVLO_L}	Falling threshold	2.9	3.12		V
Input UVLO Hysteresis	V _{UVLO_HYS}			530		mV
Shutdown Current into VIN	I _{SD}	V _{EN} = 0V		2	6	μA
Quiescent Current into VIN	I _Q	V _{IN} = 12V, V _{FB} = 1.2V, PFM mode, non-switching		28	40	μA
Enable						
EN Input Threshold of Turning On Internal LDO	V _{EN-VCC_H}	EN Rising			1	V
EN Input Threshold of Turning Off Internal LDO	V _{EN-VCC_L}	EN Falling	0.3			V
EN Input Threshold of Start Switching	V _{EN_H}	EN Rising	1.200	1.232	1.265	V
Enable Hysteresis	V _{EN_HYS}			100		mV
Input Leakage Current at EN Pin	I _{EN}	V _{EN} = 4V		4		nA
Voltage Reference						
Reference Voltage	V _{REF}	V _{IN} = 6V to 36V	0.980	1.000	1.015	V
Input Leakage Current at FB Pin	I _{LKG_FB}	V _{FB} = 1V		1.5	50	nA
Internal LDO						
Internal LDO Output Voltage	V _{CC}	V _{IN} = 6V to 36V	4.75	5.0	5.25	V
Bootstrap Voltage Under-Voltage Lockout Threshold ⁽¹⁾	V _{BOOT_UVLO_H}	Rising threshold		2.91		V
	V _{BOOT_UVLO_L}	Falling threshold		2.42		
Integrated MOSFETs						
High-side MOSFET On-Resistance	R _{DSON_HS}	V _{IN} = 12V, I _{OUT} = 0.8A		65	140	mΩ
Low-side MOSFET On-Resistance	R _{DSON_LS}	V _{IN} = 12V, I _{OUT} = 0.8A		42	95	mΩ
Current Limit						
Peak Inductor Current Limit	I _{HS_LIMIT}		3.6	4.8	5.9	A
Valley Inductor Current Limit	I _{LS_LIMIT}		2.7	3.7	4.7	A
Minimum Peak Inductor Current ⁽¹⁾	I _{PEAK_MIN}			0.5		A
Zero Cross Current Limit ⁽¹⁾	I _{L_ZC}			0.05		A
Hiccup Mode						
Hiccup Retry Delay Time ⁽¹⁾	t _{OC}			80		ms
Soft-Start						
Internal Soft-Start Time	t _{SS}		2.9	4	6	ms

ELECTRICAL CHARACTERISTICS (continued)(V_{IN} = 12V, T_J = -40°C to +125°C, typical values are at T_J = +25°C, unless otherwise noted.)

PARAMETER	SYMBOL	CONDITIONS	MIN	TYP	MAX	UNITS
Power-Good (PG Pin)						
Power-Good Upper Threshold - Rising	V _{PG_HIGH_UP}	% of FB voltage	105	108	112	%
Power-Good Upper Threshold - Falling	V _{PG_HIGH_DN}	% of FB voltage	102	105	109	%
Power-Good Lower Threshold - Rising	V _{PG_LOW_UP}	% of FB voltage	92	95	99	%
Power-Good Lower Threshold - Falling	V _{PG_LOW_DN}	% of FB voltage	89	92	96	%
Power-Good Glitch Filter Delay	t _{PG_RISE}		90	130	160	μs
	t _{PG_FALL}		80	120	165	
Power-Good Flag R _{DS(on)} V _{PG_HIGH_UP}	R _{PG}	V _{IN} = 12V, V _{EN} = 4V		40	55	Ω
		V _{EN} = 0V		40	55	
Minimum Input Voltage for Proper PG Function	V _{IN_PG}	I _{PG} = 50μA, V _{EN} = 0V			1.5	V
PG Logic Low Output	V _{PG}	I _{PG} = 50μA, V _{EN} = 0V, V _{IN} = 2V			0.2	V
Maximum Switch Duty Cycle ⁽¹⁾	D _{MAX}			98.5		%
SW (SW Pin)						
Switching Frequency	f _{SW}	SGM61330AQ	335	400	475	kHz
		SGM61330CQ	1.75	2.1	2.35	MHz
Minimum Turn-On Time ⁽¹⁾	t _{ON_MIN}			75		ns
Minimum Turn-Off Time ⁽¹⁾	t _{OFF_MIN}			50		ns
System Characteristics						
Input Supply Current When in Regulation ⁽¹⁾	I _{SUPPLY}	V _{IN} = 12V, V _{OUT} = 3.3V, I _{OUT} = 0A, R _{FBT} = 1MΩ		30		μA
Dropout Voltage (V _{IN} - V _{OUT}) ⁽¹⁾	V _{DROP}	V _{OUT} = 5V, I _{OUT} = 1A, dropout at -1% of regulation, f _{SW} = 130kHz		140		mV
FB Pin Voltage Required to Trip Short-Circuit Hiccup Mode ⁽¹⁾	V _{HC}			0.4		V
Switch Voltage Dead Time ⁽¹⁾⁽²⁾	t _D			6		ns
Thermal Shutdown Threshold ⁽¹⁾	T _{SD}			165		°C
Thermal Shutdown Hysteresis ⁽¹⁾	T _{HYS}			15		°C

NOTES:

- Guaranteed by design, not tested in production.
- The switch voltage dead time is the test result of SGM61330CQ.

TYPICAL PERFORMANCE CHARACTERISTICS

$V_{IN} = 12V$, $V_{OUT} = 5V$, the corresponding BOM can be found in Table 1, $T_A = +25^\circ C$, unless otherwise noted.

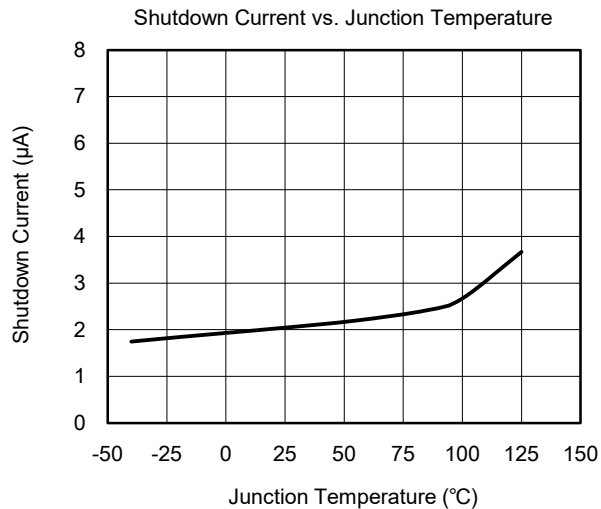
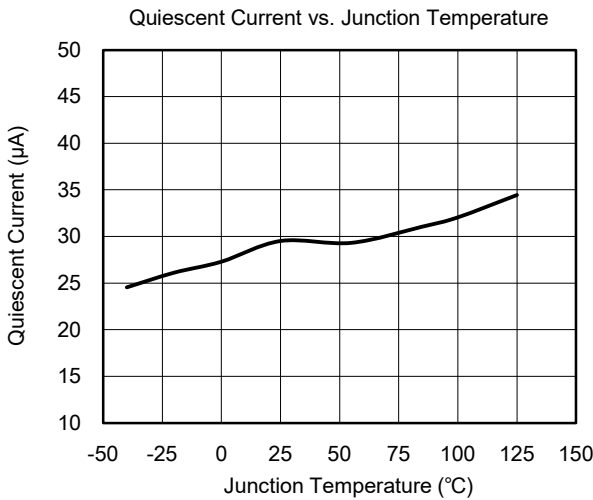
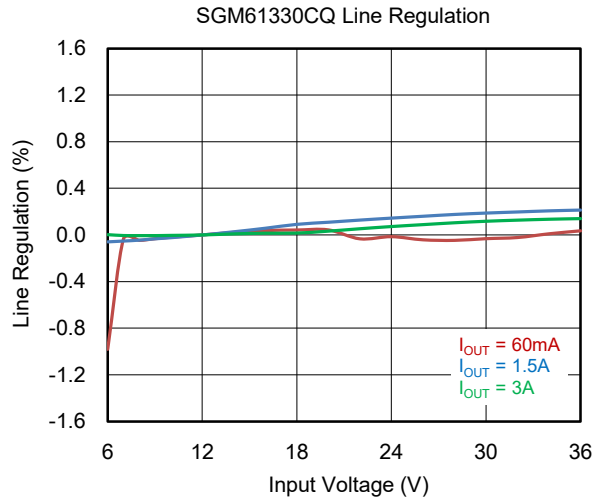
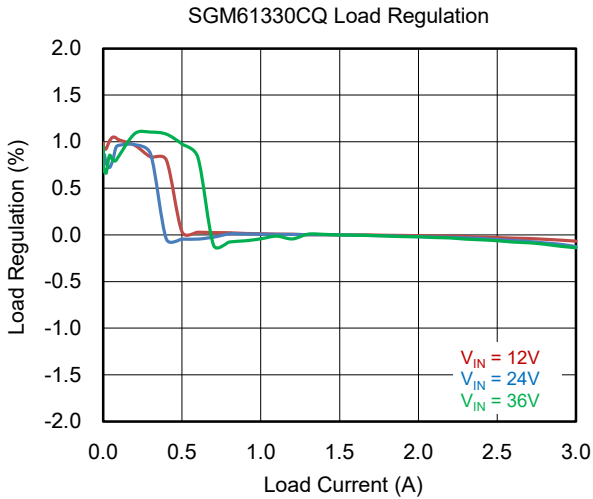
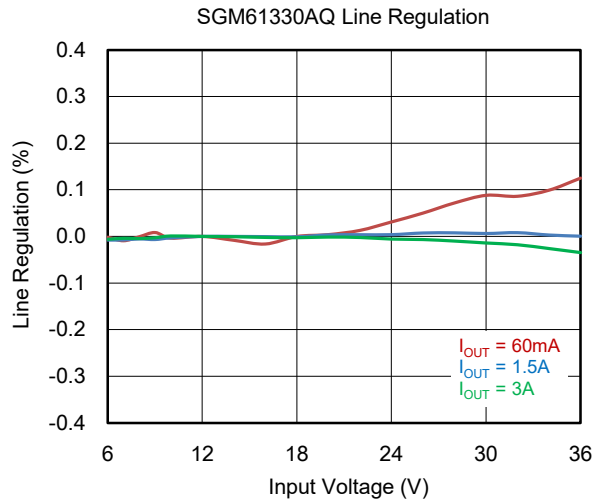
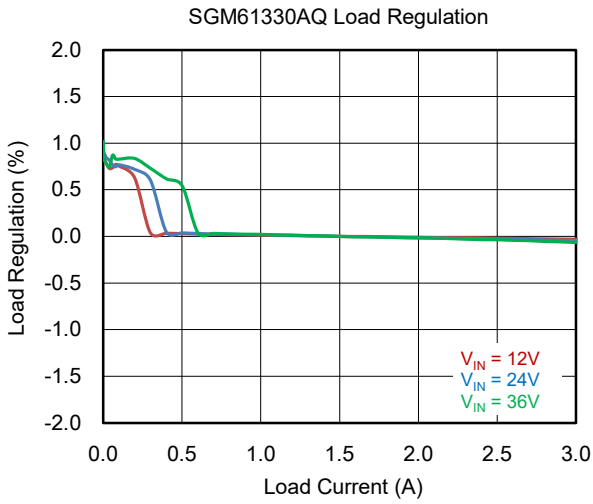

TYPICAL PERFORMANCE CHARACTERISTICS (continued)

$V_{IN} = 12V$, $V_{OUT} = 5V$, the corresponding BOM can be found in Table 1, $T_A = +25^\circ C$, unless otherwise noted.

Quiescent Current vs. Input Voltage

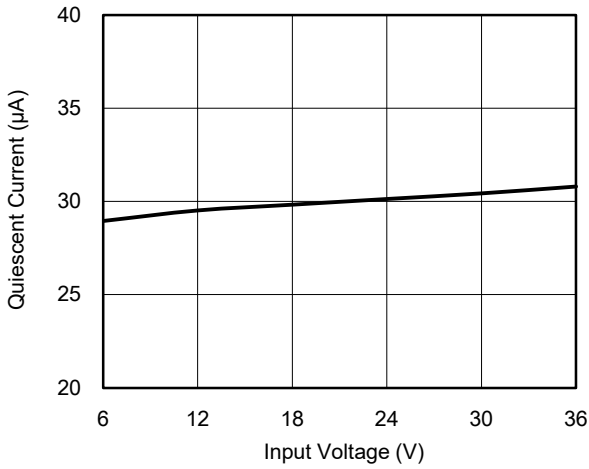

Shutdown Current vs. Input Voltage

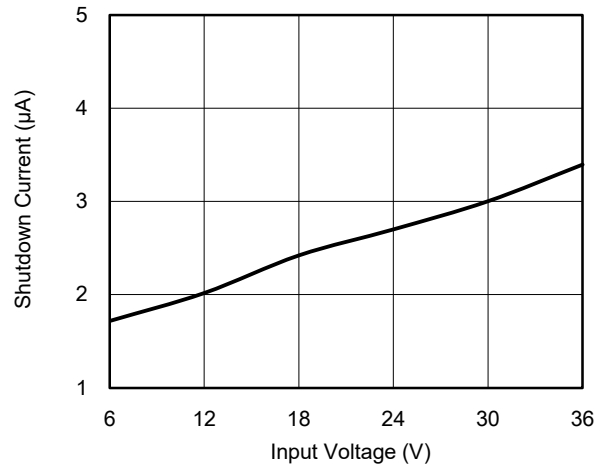

V_{IN_UVLO} Rising Threshold vs. Junction Temperature

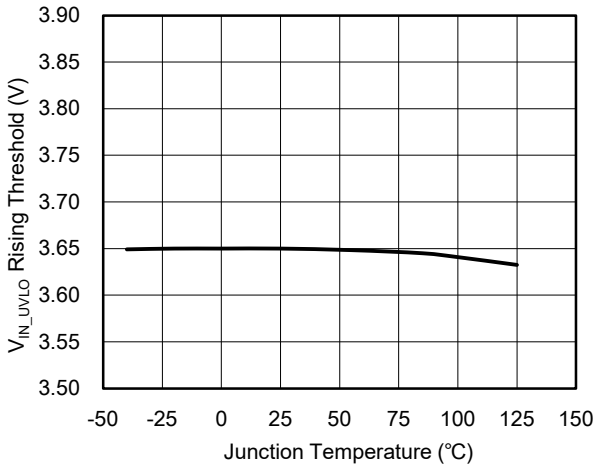

V_{IN_UVLO} Hysteresis vs. Junction Temperature

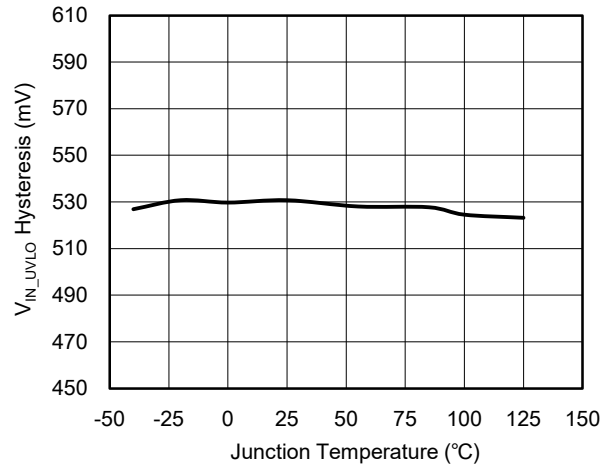

V_{EN} Rising Threshold vs. Junction Temperature

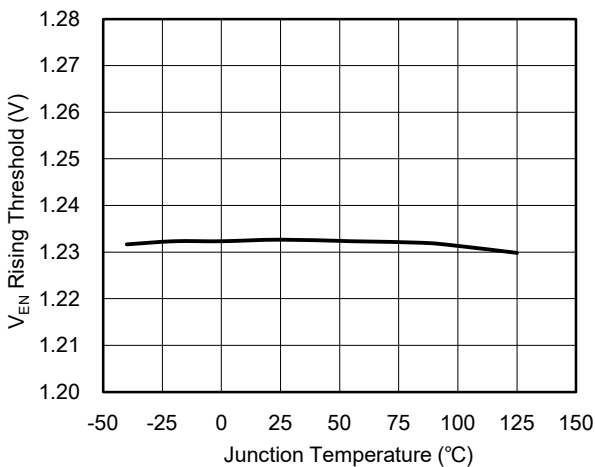

V_{EN} Hysteresis vs. Junction Temperature

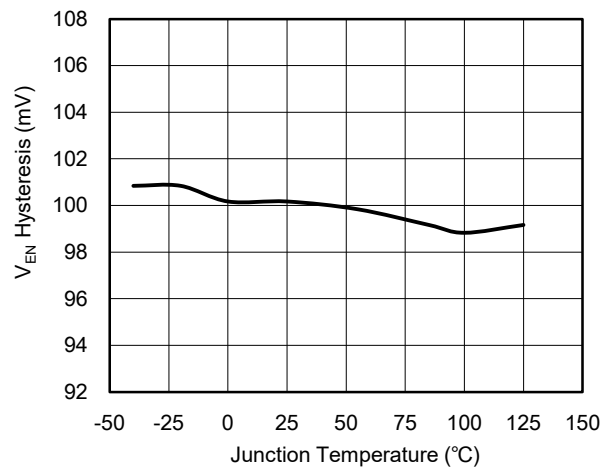

TYPICAL PERFORMANCE CHARACTERISTICS (continued)

$V_{IN} = 12V$, $V_{OUT} = 5V$, the corresponding BOM can be found in Table 1, $T_A = +25^\circ C$, unless otherwise noted.

Reference Voltage vs. Junction Temperature

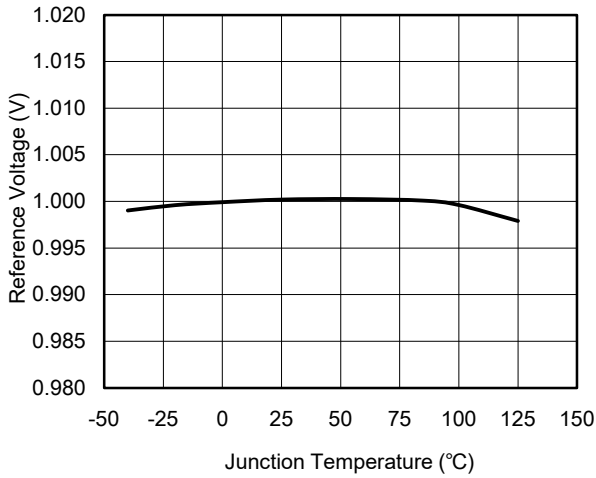

Overall Dropout Characteristic

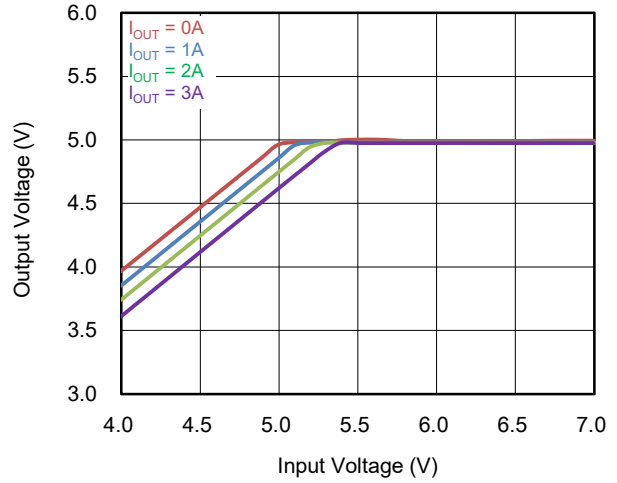

SGM61330AQ Efficiency vs. Load Current

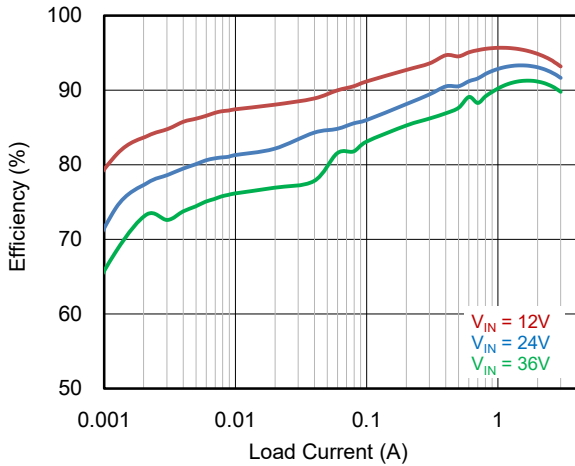

SGM61330CQ Efficiency vs. Load Current

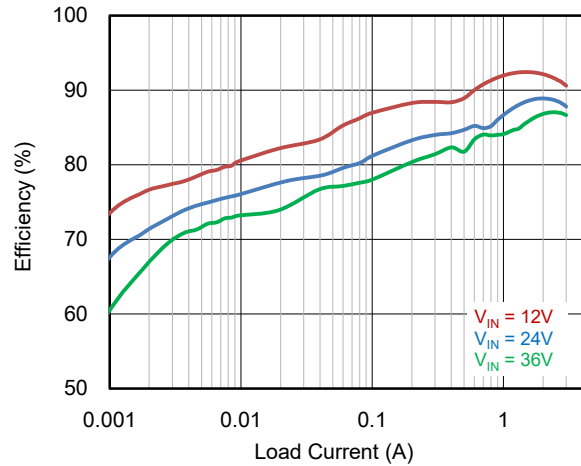

TYPICAL PERFORMANCE CHARACTERISTICS (continued)

$V_{IN} = 12V$, $V_{OUT} = 5V$, the corresponding BOM can be found in Table 1, $T_A = +25^{\circ}C$, unless otherwise noted.

SGM61330AQ Load Transient

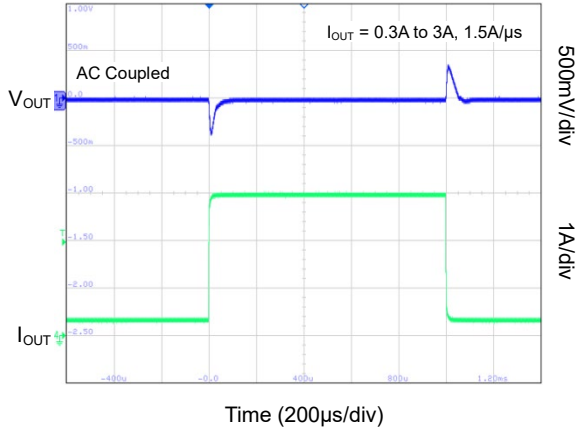

SGM61330CQ Load Transient

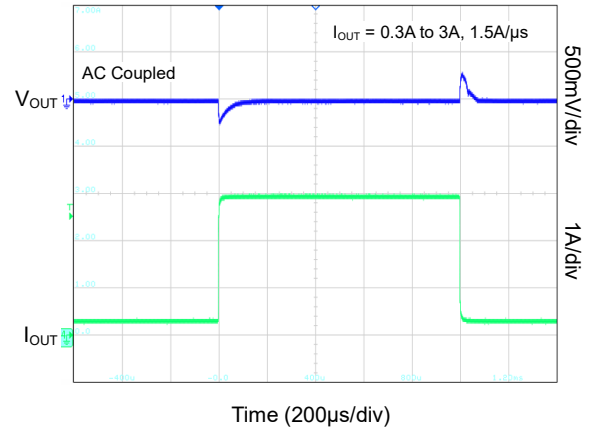

SGM61330AQ CCM Mode

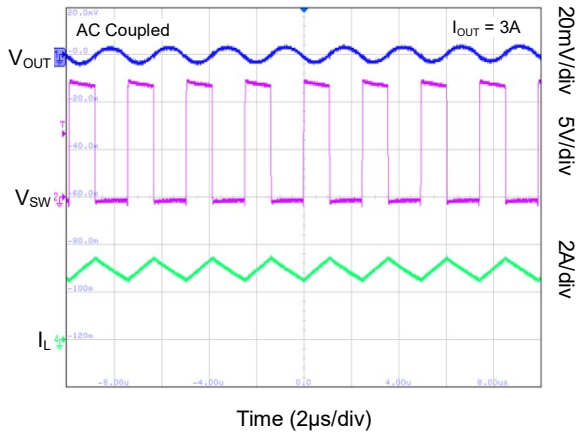

SGM61330CQ CCM Mode

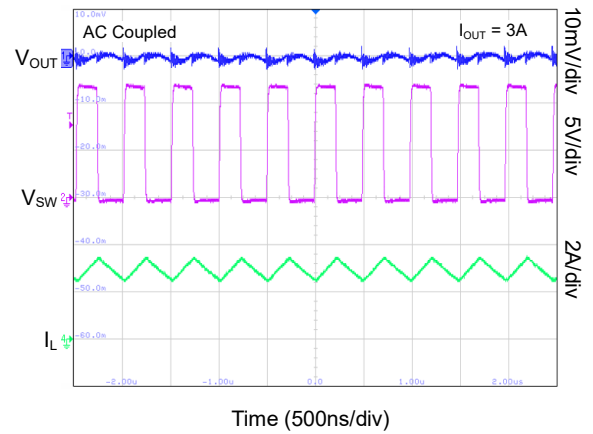

SGM61330AQ PFM Mode

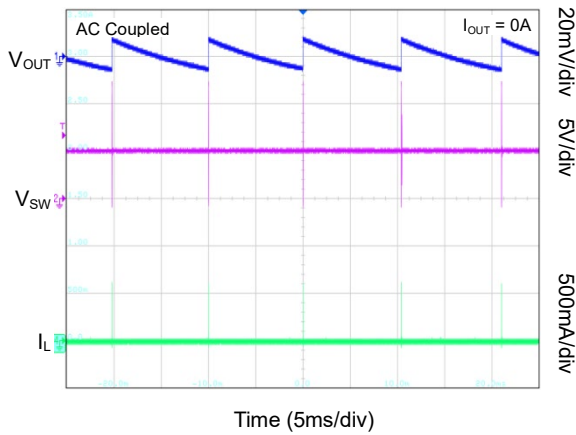

SGM61330CQ PFM Mode

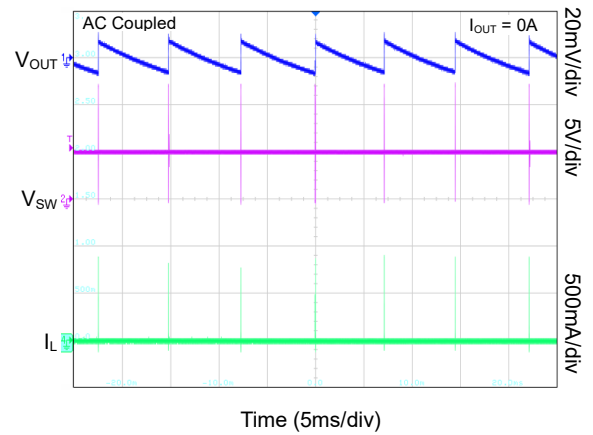

TYPICAL PERFORMANCE CHARACTERISTICS (continued)

$V_{IN} = 12V$, $V_{OUT} = 5V$, the corresponding BOM can be found in Table 1, $T_A = +25^\circ C$, unless otherwise noted.

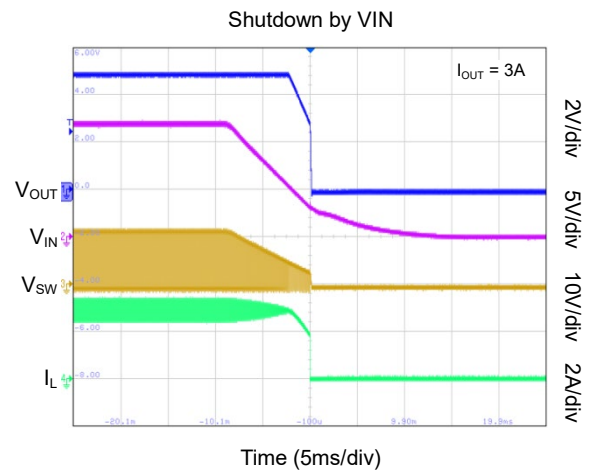
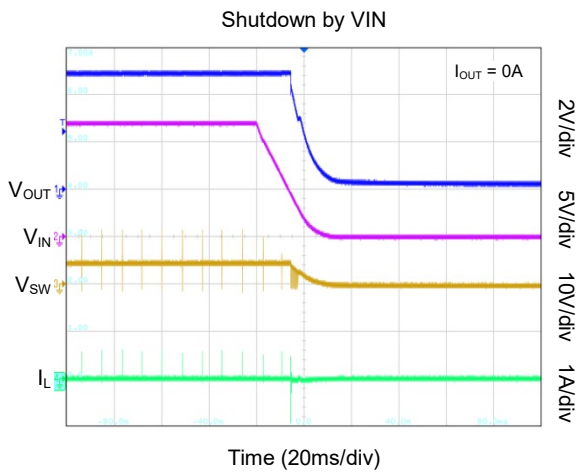
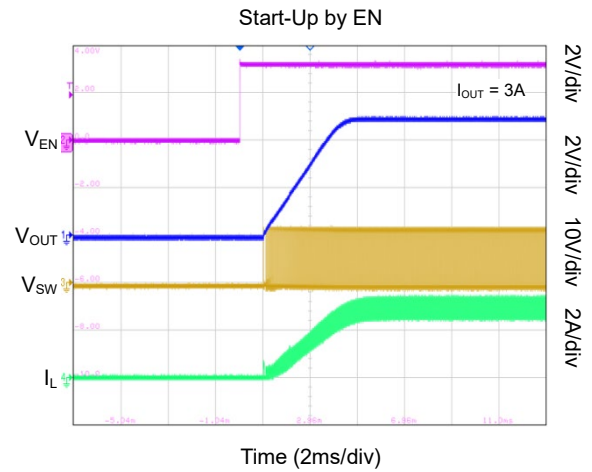
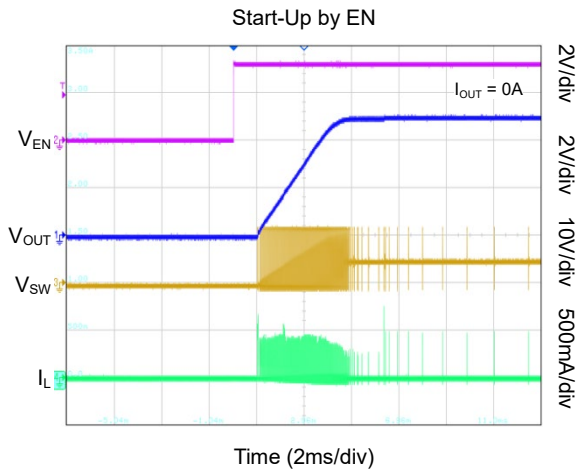
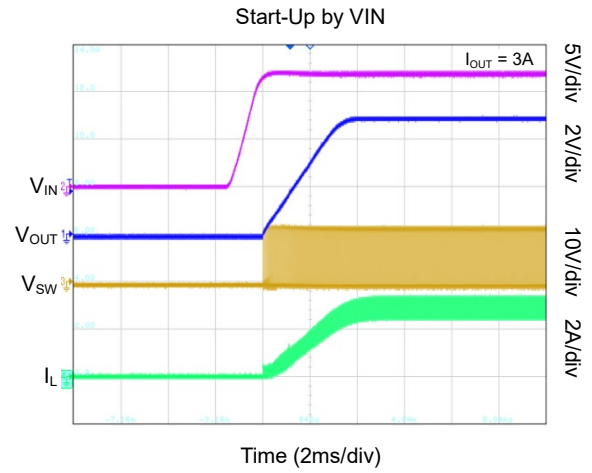
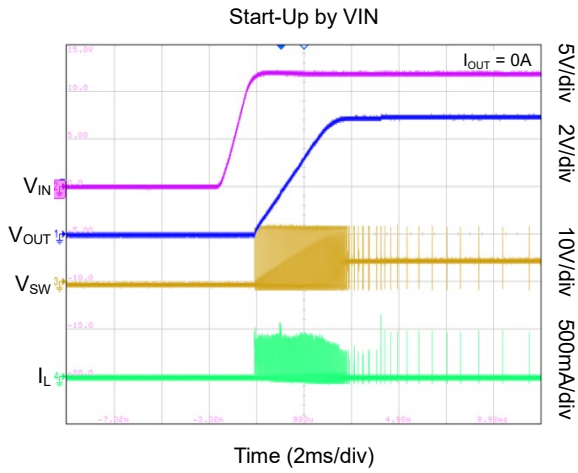

TYPICAL PERFORMANCE CHARACTERISTICS (continued)

$V_{IN} = 12V$, $V_{OUT} = 5V$, the corresponding BOM can be found in Table 1, $T_A = +25^\circ C$, unless otherwise noted.

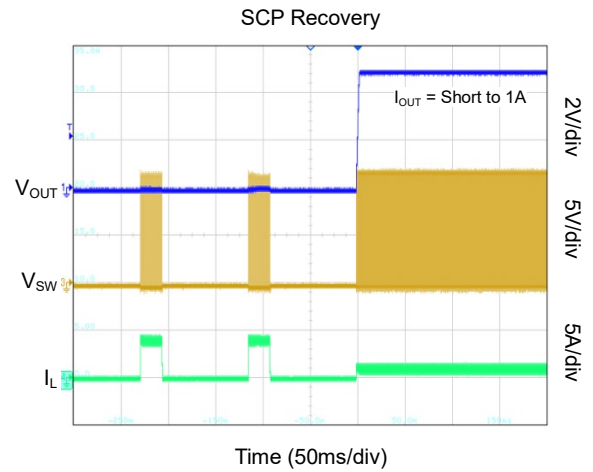
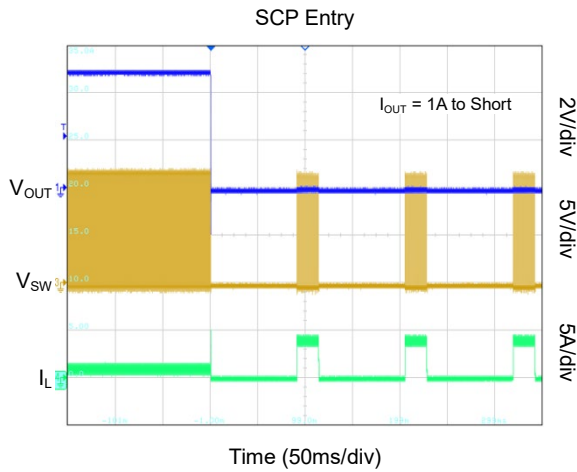
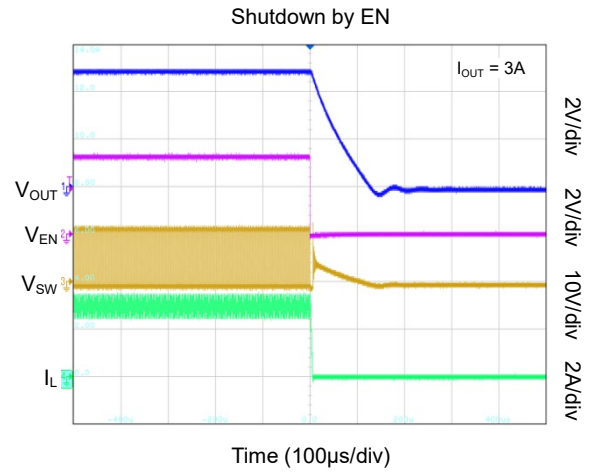
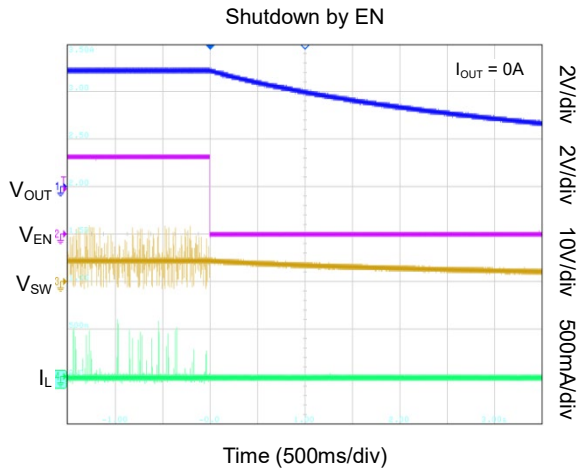

FUNCTIONAL BLOCK DIAGRAM

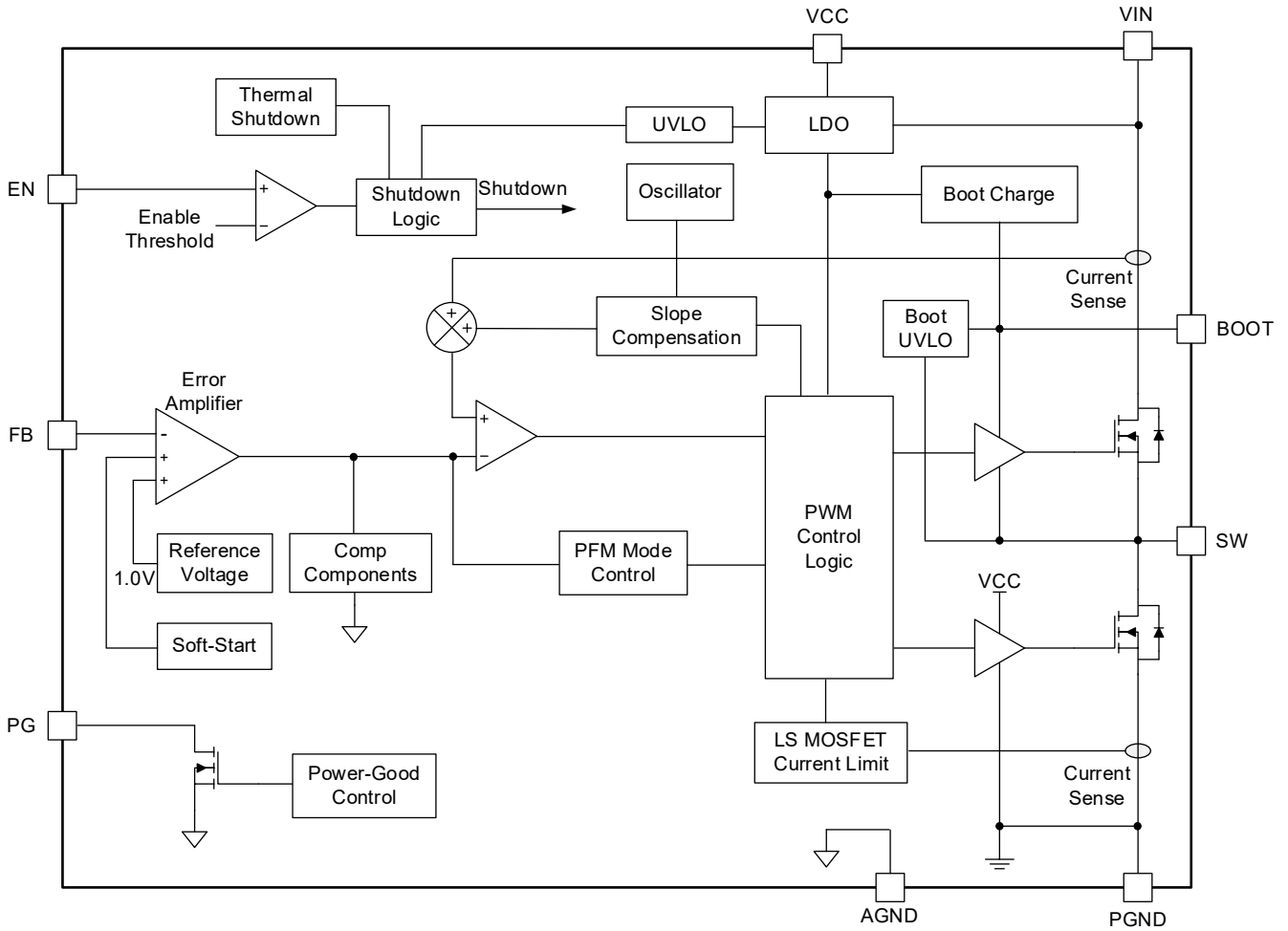

Figure 2. Block Diagram

DETAILED DESCRIPTION

Overview

The SGM61330xQ is a 36V synchronous Buck converter with two integrated N-MOSTETs and 3A continuous output current capability. Its internally compensated peak current mode control simplifies the design process and reduces the need for external components.

The minimum operating input voltage of the device is 3.8V. The output voltage can be set down to 1V (reference voltage). Typical no switching operating current is 28µA (TYP). The shutdown current is 2µA (TYP) if the device is disabled. High efficiency is achieved through the integrated low R_{DS(ON)} high-side switch (65mΩ) and low-side switch (42mΩ).

The bootstrap diode is integrated, and only a small capacitor (C_{BOOT}) between BOOT and SW pins is needed for the high-side MOSFET gate driving bias. The device also features a separate UVLO circuit that monitors C_{BOOT} voltage.

Additional features such as thermal shutdown, over-voltage protection, and short-circuit protection (hiccup mode) are also provided.

Minimum Input Voltage (3.8V) and UVLO

The recommended minimum operating input voltage is 3.8V. The device can operate with lower input voltages that are above the V_{IN} rising UVLO threshold (3.65V TYP). The V_{IN} UVLO threshold has a hysteresis of 530mV (TYP). If V_{IN} falls below the falling UVLO voltage, the device will stop switching. If the EN pin is pulled high and V_{IN} exceeds the rising UVLO threshold, the device will start up with a soft-start.

Enable Input and UVLO Adjustment

The EN pin serves as an on/off control for the device. When the EN voltage is greater than V_{EN-VCC_H} (1V MAX), the device enters standby mode, where it supplies power to the internal VCC but does not generate an output voltage. To fully enable the device, continue to increase the EN voltage until it is above V_{EN_H} (1.232V TYP). If the EN voltage falls below V_{EN_H} - V_{EN_HYS} (1.132V TYP), the device will stop switching and enter standby mode. When the EN voltage is below V_{EN-VCC_L} (0.3V MIN), the device will be completely shut down.

If an application requires increasing the V_{IN} turn-on threshold and adding hysteresis to the V_{IN} UVLO, a voltage divider as shown in Figure 3 is required. Use

Equation 1 and 2 to calculate these resistors. V_{START} is the input start (turn-on) threshold voltage and V_{STOP} is the input stop (turn-off) threshold voltage.

$$R_{EN1} = \left(\frac{V_{START}}{V_{EN_H}} - 1 \right) \times R_{EN2} \tag{1}$$

$$V_{STOP} = V_{START} \times \left(1 - \frac{V_{EN_HYS}}{V_{EN_H}} \right) \tag{2}$$

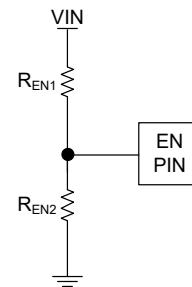

Figure 3. VIN UVLO Adjustment

Power-Good

The SGM61330xQ features a power-good (PG) pin that indicates whether the output voltage is at the desired level. This pin is an open-drain output that requires a resistor of 10kΩ pulled up to a DC voltage. The current flowing into PG pin must not exceed 5mA.

Figure 4 illustrates that when the FB voltage is within the power-good range, the PG switch is turned off, and the PG pin is pulled up to high. Conversely, when the FB voltage is outside the power-good range, the PG switch is turned on, and the PG pin is pulled down to low. If the power-good function is not required, the PG pin must be left floating. When EN is pulled low, the flag output will also be forced low.

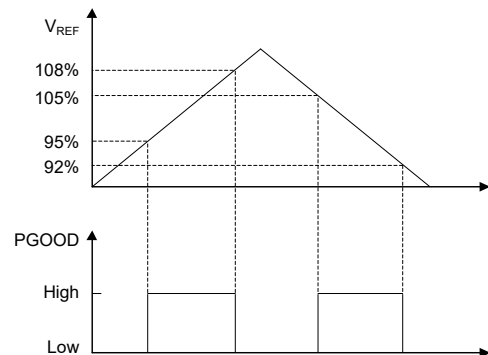

Figure 4. Power-Good Flag

DETAILED DESCRIPTION (continued)

Bootstrap Gate Driving (BOOT)

An internal voltage regulator provides bias voltage to the gate driver through an external small ceramic capacitor placed between the BOOT and SW pins. A 100nF ceramic capacitor with X5R or better grade dielectric is recommended. The capacitor must have a 10V or higher voltage rating. Typically, C_{BOOT} is charged during each cycle when the LS switch is turned on and discharged to the boot regulator when the HS switch is turned on.

Light Load Operation with PFM

The SGM61330xQ employs pulse frequency modulation (PFM) to achieve a lower switching frequency and maintain regulation. This leads to a reduction in switching losses along with an enhancement in efficiency. The device operates in PFM mode when the output load is low and shifts to pulse width modulation (PWM) mode when the load increases to a certain level.

Low Dropout

As input voltage drops, the difference between input voltage and output voltage decreases, causing off-time of the high-side MOSFET to approach its minimum possible value. Dropout occurs when input voltage falls below the required minimum for the regulator to maintain output voltage. To maintain output voltage at nominal value, SGM61330xQ will decrease its switching frequency and increase duty cycle.

Minimum Switch On-Time

The minimum controllable on-time of SGM61330CQ is affected by the inherent delay and blanking time of the control circuit. The minimum on-time reduces the conversion ratio of the system, restricts some applications to high input voltages and low output voltages at high switching frequencies. To solve this problem, SGM61330CQ maintains a constant turn-on time when it reaches the minimum turn-on time and decreases its switching frequency, resulting in an increased conversion ratio.

Over-Current Protection

Current mode control provides over-current protection (OCP) by HS current sensing, which compares the sensed HS switch current with the HS current-limit threshold in each cycle. When the HS current reaches that threshold, the HS switch is turned off. Then the low-side (LS) switch is turned on, the conduction current is monitored by the internal circuitry. In each cycle, the sensed LS switch current is compared to the internally LS current-limit threshold only when the HS current-limit threshold is triggered. If the sensed LS switch current is higher than the LS current-limit threshold during LS conduction, the HS does not turn on and the LS stays on when the clock signal comes. When the sensed LS switch current is below the LS current-limit threshold, for SGM61330AQ, the HS switch waits until the clock signal arrives before turning on again; whereas for SGM61330CQ, the HS switch turns on again immediately.

In addition, if FB drops below 40% of V_{REF} , then the device shuts down and restarts after 80ms (TYP). If OCP or SCP persists for more than 20ms (TYP) after the automatic restart, a new hiccup cycle will be initiated. Hiccup mode is a protective measure designed to prevent overheating and severe damage from over-current conditions.

Thermal Shutdown (TSD)

If the junction temperature (T_J) exceeds +165°C (TYP), the TSD protection circuit will stop the switch from operating to protect the device from overheating. After the junction temperature drops below +150°C (TYP), the device automatically restarts and goes through the power-up procedure.

APPLICATION INFORMATION

The design for the SGM61330xQ Buck converter is explained in this section. A typical application circuit for the SGM61330AQ is shown in Figure 5. It is used for converting a 6V to 36V supply voltage to a lower 5V output voltage with a maximum output current of 3A.

The external components are designed based on the application requirements and device stability. Some suitable parameters for different output voltages are provided in Table 1 to simplify the selection of components. The C_{OUT} values in Table 1 are rated values.

Typical Application

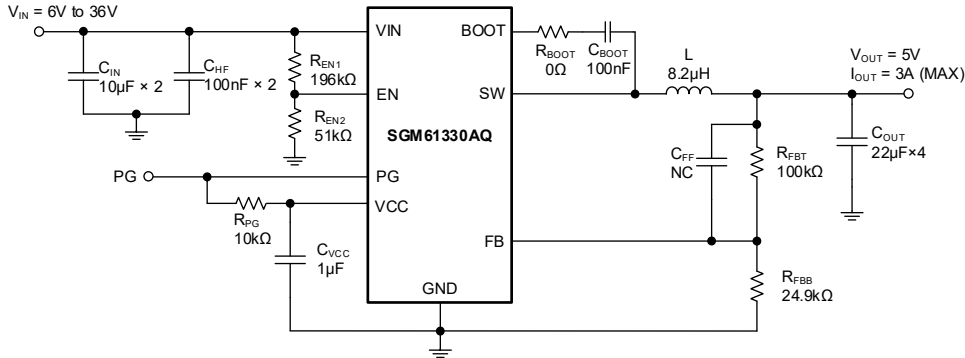

Figure 5. SGM61330AQ Typical Application Circuit

Table 1. Some Typical Parameters for Stable Operation

f _{sw} (kHz)	V _{OUT} (V)	L (µH)	C _{OUT} (µF)	R _{FBT} (kΩ)	R _{FBB} (kΩ)	C _{FF} (pF)
400	3.3	6.8	4×22	100	43.2	NC
2100	3.3	1.2	2×22	100	43.2	22
400	5	8.2	4×22	100	24.9	NC
2100	5	1.5	2×22	100	24.9	22
400	12	15	4×22	100	9.09	NC
2100	12	3.3	4×10	100	9.09	NC

Requirements

The design parameters required for the design example are given in Table 2.

Table 2. Design Parameters

Design Parameter	Example Value
Input Voltage	12V nominal
Output Voltage	5V
Output Current Rating	3A
Operating Frequency	400kHz

Switching Frequency

The SGM61330xQ has two frequencies to choose from: 400kHz (TYP) for the SGM61330AQ and 2.1MHz (TYP) for the SGM61330CQ. For this design, a switching frequency of 400kHz was chosen as an example.

APPLICATION INFORMATION (continued)

Input Capacitors Design

A high-quality ceramic capacitor (X5R or X7R or better dielectric grade) must be used for input decoupling of the SGM61330xQ. At least 3 μ F of effective capacitance (after derating) is needed at the input. In some applications, additional bulk capacitance may also be required for the input, for example, when the SGM61330xQ is more than 5cm away from the input source. The input capacitor ripple current rating must also be greater than the maximum input current ripple. The input current ripple can be calculated using Equation 3 and the maximum value occurs at 50% duty cycle. Using the design example values, $I_{OUT} = 3A$, yields an RMS input ripple current of 1.5A.

$$I_{CIN_RMS} = I_{OUT} \times \sqrt{\frac{V_{OUT} \times (V_{IN} - V_{OUT})}{V_{IN} \times V_{IN}}} = I_{OUT} \times \sqrt{D \times (1-D)} \quad (3)$$

For this design, a ceramic capacitor with at least 50V voltage rating is required to support the maximum input voltage. Therefore, two 10 μ F/50V capacitors are selected for VIN to cover all DC bias, thermal and aging derating. The input capacitance determines the regulator input voltage ripple. This ripple can be calculated from Equation 4.

$$\Delta V_{IN} = \frac{I_{OUT} \times D \times (1-D)}{C_{IN} \times f_{SW}} \quad (4)$$

It is recommended to place two additional small size 100nF/0603 ceramic capacitors (C_{HF}) right beside VIN and GND pins for high frequency filtering.

Inductor Design

Equation 5 is conventionally used to calculate the output inductance of a Buck converter. The ratio of inductor current ripple (ΔI_L) to the maximum output current (I_{OUT}) is represented as K_{IND} factor ($K_{IND} = \Delta I_L / I_{OUT}$). The inductor ripple current is bypassed and filtered by the output capacitor and the inductor DC current is passed to the output. Inductor ripple is selected based on a few considerations. The peak inductor current ($I_{OUT} + \Delta I_L / 2$) must have a safe margin from the saturation current of the inductor in the worst-case conditions. For peak current mode converter, selecting an inductor with saturation current must be above the switch current limit. Typically, a 20% to 40% current ripple is selected ($K_{IND} = 0.2 \sim 0.4$).

$$L = \frac{V_{IN} - V_{OUT}}{I_{OUT} \times K_{IND}} \times \frac{V_{OUT}}{V_{IN} \times f_{SW}} \quad (5)$$

In this example, the calculated inductance will be 8.1 μ H with $K_{IND} = 0.3$ at $V_{IN} = 12V$, therefore the nearest larger inductance of 8.2 μ H is selected. The ripple, RMS and peak inductors current calculations are summarized in Equations 6, 7 and 8 respectively.

$$\Delta I_L = \frac{V_{IN} - V_{OUT}}{L} \times \frac{V_{OUT}}{V_{IN} \times f_{SW}} \quad (6)$$

$$I_{L_RMS} = \sqrt{I_{OUT}^2 + \frac{\Delta I_L^2}{12}} \quad (7)$$

$$I_{L_PEAK} = I_{OUT} + \frac{\Delta I_L}{2} \quad (8)$$

APPLICATION INFORMATION (continued)

Output Capacitor Design

There are three main criteria that must be considered when designing the output capacitor (C_{OUT}): (1) the converter pole location, (2) the output voltage ripple, (3) the transient response to a large change in load current. The selected value must satisfy all of them. The desired transient response is usually expressed as maximum overshoot, maximum undershoot, or maximum recovery time of V_{OUT} in response to a large load step. Transient response is usually the more stringent criteria in low output voltage applications. The output capacitor must provide the increased load current or absorb the excess inductor current until the control loop can re-adjust the current of the inductor to the new load level. Typically, it requires two or more cycles for the loop to detect and respond to the output change. Another requirement may also be expressed as desired hold-up time in which the output capacitor must hold the output voltage above a certain level for a specified period if the input power is removed. It may also be expressed as the maximum output voltage drop or rise when the full load is connected or disconnected (100% load step). Equation 9 can be used to calculate the minimum output capacitance that is needed to supply a current step (ΔI_{OUT}) for at least 2 cycles until the control loop responds to the load change with a maximum allowed output transient of ΔV_{OUT} (overshoot or undershoot).

$$C_{OUT} > \frac{2 \times \Delta I_{OUT}}{f_{SW} \times \Delta V_{OUT}} \quad (9)$$

where:

- ΔI_{OUT} is the change in output current.
- ΔV_{OUT} is the allowable change in the output voltage.

For example, if the acceptable transient from 1.5A to 3A load step is 5%, by inserting $\Delta V_{OUT} = 0.05 \times 5V =$

0.25V and $\Delta I_{OUT} = 1.5A$, the minimum required capacitance will be 30 μ F. Note that the impact of output capacitor ESR on the transient is not considered in Equation 9. For ceramic capacitors, the ESR is generally small enough to ignore its impact on the calculation of ΔV_{OUT} transient.

The output capacitor must also be sized to absorb energy stored in the inductor when transitioning from a high to low load current. The energy stored in the inductor can produce an output voltage overshoot when the load current rapidly decreases. The excess energy absorbed in the output capacitor increases the voltage on the capacitor. The capacitor must be sized to maintain the desired output voltage during these transient periods. Equation 10 calculates the minimum capacitance required to keep the output-voltage overshoot to a desired value.

$$C_{OUT} > L \times \frac{I_{OUT_H}^2 - I_{OUT_L}^2}{(V_{OUT} + \Delta V_{OUT})^2 - V_{OUT}^2} \quad (10)$$

where:

- I_{OUT_H} is the output current under heavy load.
- I_{OUT_L} is the output current under light load.

For example, if the acceptable transient from 3A to 1.5A load step is 5%, by inserting $\Delta V_{OUT} = 0.05 \times 5V = 0.25V$, the minimum required capacitance will be 21.6 μ F.

Equation 11 can be used for the output ripple criteria and finding the minimum output capacitance needed. V_{OUT_RIPPLE} is the maximum acceptable ripple. In this example, the allowed ripple is 50mV that results in minimum capacitance of 5.6 μ F.

$$C_{OUT} > \frac{\Delta I_L}{8 \times f_{SW} \times V_{OUT_RIPPLE}} \quad (11)$$

APPLICATION INFORMATION (continued)

Note that the impact of output capacitor ESR on the ripple is not considered in Equation 11. For a specific output capacitance value, use Equation 12 to calculate the maximum acceptable ESR of the output capacitor to meet the output voltage ripple requirement.

$$ESR_{C_{OUT}} < \frac{V_{OUT_RIPPLE}}{\Delta I_L} \cdot \frac{1}{8 \times f_{SW} \times C_{OUT}} \quad (12)$$

Higher nominal capacitance value must be chosen due to aging, temperature, and DC bias derating of the output capacitors. In this example, four 22 μ F/25V ceramic capacitors are used. The amount of ripple current that a capacitor can handle without damage or overheating is limited. The inductor ripple is bypassed through the output capacitor. Equation 13 calculates the RMS current that the output capacitor must support.

$$I_{C_{OUT_RMS}} = \frac{V_{OUT} \times (V_{IN_MAX} - V_{OUT})}{\sqrt{12} \times V_{IN_MAX} \times L \times f_{SW}} \quad (13)$$

Bootstrap Capacitor Selection

Use a 100nF high-quality ceramic capacitor (X7R or X5R) with 10V or higher voltage rating for the bootstrap capacitor (C_{BOOT}). It is recommended to add a resistor R_{BOOT} in series with C_{BOOT} to slow down switch-on speed of the HS switch and improve radiated EMI problems. For most applications, R_{BOOT} is used around 5 Ω ~ 10 Ω . Too high values for R_{BOOT} may cause insufficient C_{BOOT} charging in high duty-cycle applications. Slower switch switch-on speed will also increase switch losses and reduce efficiency.

UVLO Setting

The input UVLO can be programmed using an external voltage divider on the EN pin of the SGM61330xQ, as shown in Figure 3. In this design, the turn-on (enable to start switching) occurs when V_{IN} rises above 6V (UVLO rising threshold). When the regulator is working, it will not stop switching until the input falls below 5.5V (UVLO falling threshold). Equations 1 and 2 are provided to calculate R_{EN1} and V_{STOP} , respectively.

Feedback Resistors Setting

Use resistor dividers (R_{FBT} and R_{FBB}) to set the output voltage using Equation 14 and 15.

$$R_{FBB} = \frac{R_{FBT} \times V_{REF}}{V_{OUT} - V_{REF}} \quad (14)$$

$$V_{OUT} = V_{REF} \times \left(\frac{R_{FBT}}{R_{FBB}} + 1 \right) \quad (15)$$

Recommended to choose R_{FBT} around 100k Ω and calculate R_{FBB} from Equation 14. Use accurate and stable resistors (1% or better) to enhance output accuracy. For this example, the selected values are $R_{FBT} = 100k\Omega$ and $R_{FBB} = 24.9k\Omega$, resulting in a 5.016V output voltage.

C_{FF} Selection

Even though the SGM61330xQ is internally compensated, with low ESR ceramic capacitors, the phase margin can be low depending on the V_{OUT} and f_{SW} values. By adding an external feed-forward capacitor (C_{FF}) in parallel with the R_{FBT} , the phase margin can be improved (phase boost around crossover frequency). Without C_{FF} , and if ESR is very small, the crossover frequency (f_x) can be estimated from Equation 16, in which C_{OUT} is the actual derated value:

$$f_x = \frac{K}{V_{OUT} \times C_{OUT}} \quad (16)$$

where:

- K = 7.27 for SGM61330AQ.
- K = 11.14 for SGM61330CQ.

Then C_{FF} value can be estimated from:

$$C_{FF} = \frac{1}{2\pi \times f_x \times R_{FBT}} \quad (17)$$

For slightly larger ESR values, choose a C_{FF} value that is less than Equation 17 estimate. For larger ESR values, C_{FF} is not needed. Table 1 gives a quick starting point.

APPLICATION INFORMATION (continued)

Layout Considerations

Example of PCB layout for SGM61330xQ is provided in Figure 6. The layout has been shown to bring good results, although other layout designs may also obtain good performance.

- Bypass the VIN pin to GND pin with low-ESR ceramic capacitors (10µF/X5R or better) and place them as close as possible to the device.
- Share the same GND connection point with the input and output capacitors.
- Connect the device GND to the PCB ground plane right at the GND pin.
- Minimize the length and the area of the connection route from SW pin to the inductor to reduce the noise coupling from this area.
- Consider sufficient ground plane area on the top side for proper heat dissipation. Connect the large internal or back-side ground planes to the top-side ground near the device with thermal vias for better heat dissipation.

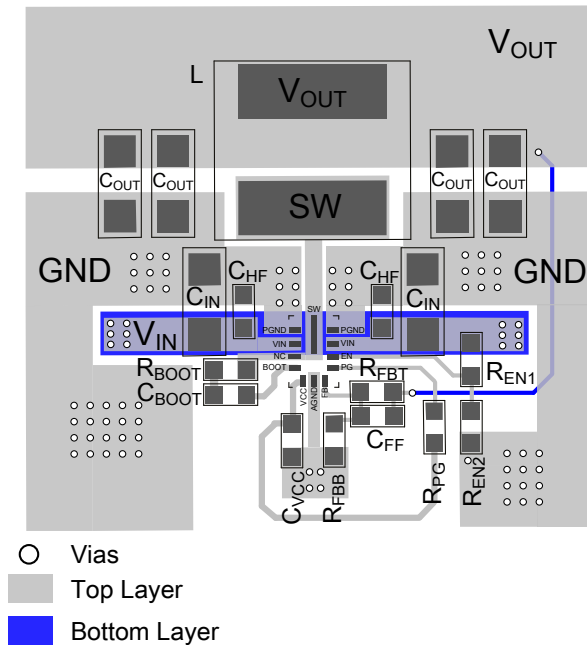

Figure 6. Example of PCB Layout

REVISION HISTORY

NOTE: Page numbers for previous revisions may differ from page numbers in the current version.

DECEMBER 2025 – REV.A.1 to REV.A.2	Page
Updated Electrical Characteristics and Detailed Description	5, 13
<hr/>	
MAY 2025 – REV.A to REV.A.1	Page
Updated Detailed Description	14
<hr/>	
Changes from Original (JULY 2024) to REV.A	Page
Changed from product preview to production data	All

PACKAGE OUTLINE DIMENSIONS

TQFN-2x3-12BL

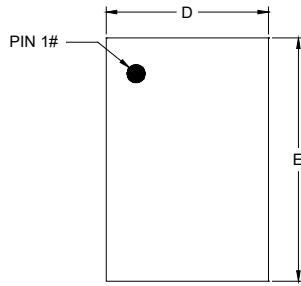

TOP VIEW

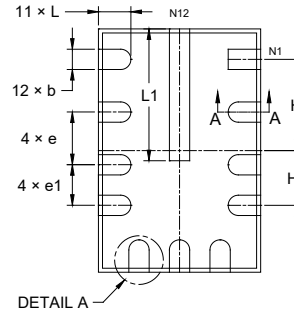

BOTTOM VIEW

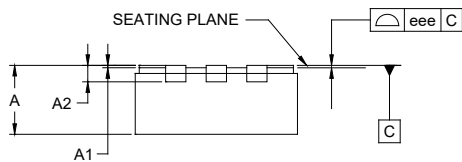

SIDE VIEW



DETAIL A
ALTERNATE TERMINAL
CONSTRUCTION

SECTION A-A
TERMINAL CROSS SECTION

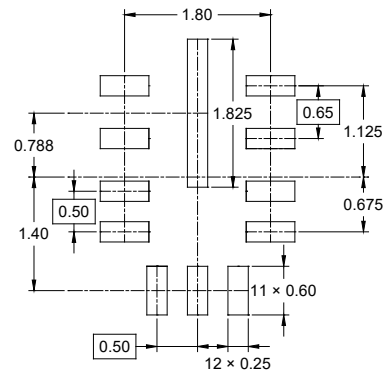

RECOMMENDED LAND PATTERN (Unit: mm)

Symbol	Dimensions In Millimeters		
	MIN	NOM	MAX
A	0.800	-	0.900
A1	0.000	-	0.050
A2	0.203 REF		
b	0.200	-	0.300
D	1.900	-	2.100
E	2.900	-	3.100
e	0.650 BSC		
e1	0.500 BSC		
H	1.125 BSC		
H1	0.675 BSC		
L	0.300	-	0.500
L1	1.525	-	1.725
eee	0.080		

NOTE: This drawing is subject to change without notice.

TAPE AND REEL INFORMATION

REEL DIMENSIONS

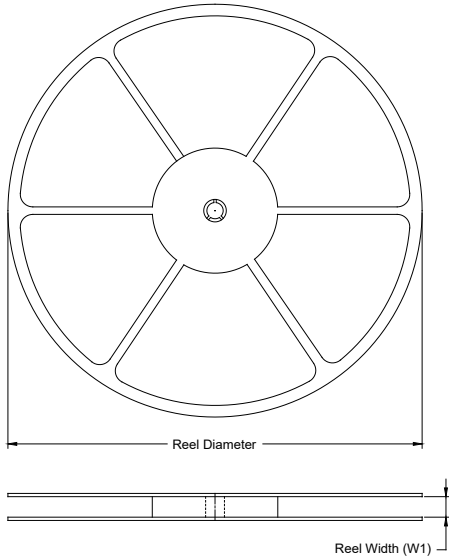

TAPE DIMENSIONS

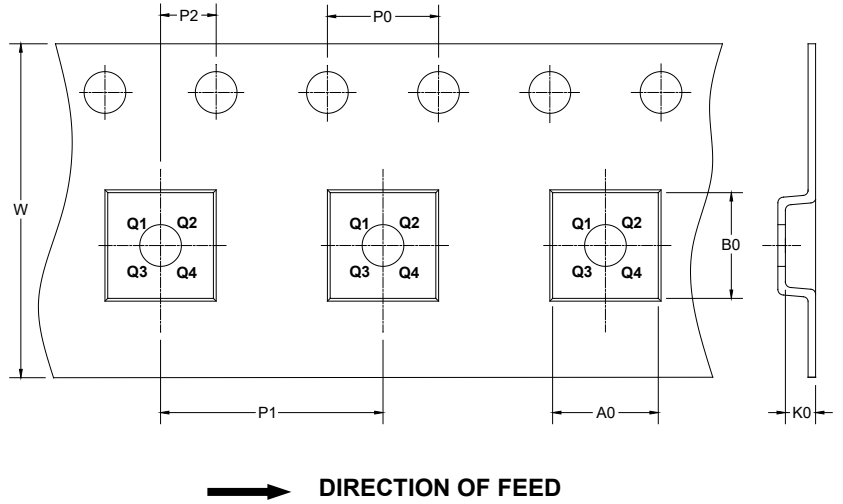

NOTE: The picture is only for reference. Please make the object as the standard.

KEY PARAMETER LIST OF TAPE AND REEL

Package Type	Reel Diameter	Reel Width W1 (mm)	A0 (mm)	B0 (mm)	K0 (mm)	P0 (mm)	P1 (mm)	P2 (mm)	W (mm)	Pin1 Quadrant
TQFN-2×3-12BL	7"	9.5	2.30	3.30	1.10	4.0	4.0	2.0	8.0	Q1

DD0001

PACKAGE INFORMATION

CARTON BOX DIMENSIONS

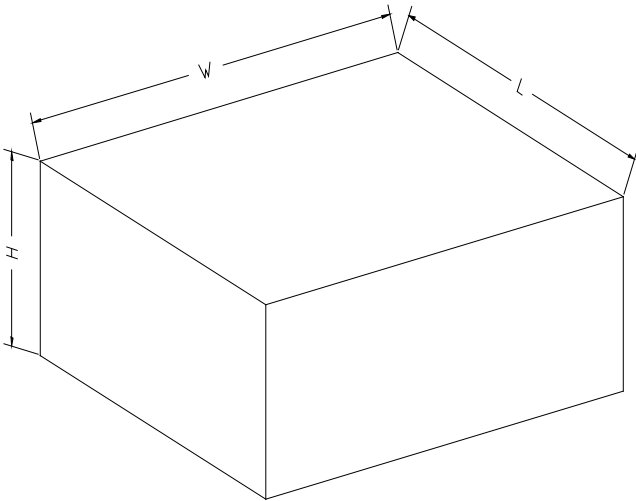

NOTE: The picture is only for reference. Please make the object as the standard.

KEY PARAMETER LIST OF CARTON BOX

Reel Type	Length (mm)	Width (mm)	Height (mm)	Pizza/Carton
7" (Option)	368	227	224	8
7"	442	410	224	18

D00002