



SGM8634

470 μ A, 6MHz, Rail-to-Rail I/O CMOS Operational Amplifier

GENERAL DESCRIPTION

The SGM8634 is a quad, low voltage, low noise and low power operational amplifier, which can operate from 2.5V to 5.5V single supply, while consuming only 470 μ A quiescent current per amplifier at 5V.

The SGM8634 features a 3.5mV maximum input offset voltage. The minimum input common mode voltage is within 0.1V below the negative rail, and the output swing is rail-to-rail with heavy loads. It exhibits a high gain-bandwidth product of 6MHz and a slew rate of 3.7V/ μ s. These specifications make the operational amplifier appropriate for various applications.

The SGM8634 is available in Green TSSOP-14 and SOIC-14 packages. It is specified over the extended -40°C to +125°C industrial temperature range.

FEATURES

- **Input Offset Voltage: 3.5mV (MAX)**
- **High Gain-Bandwidth Product: 6MHz**
- **High Slew Rate: 3.7V/ μ s**
- **Settling Time to 0.1% with 2V Step: 2.1 μ s**
- **Overload Recovery Time: 0.9 μ s**
- **Low Noise: 12nV/ $\sqrt{\text{Hz}}$**
- **Rail-to-Rail Input and Output**
- **Supply Voltage Range: 2.5V to 5.5V**
- **Input Voltage Range: -0.1V to 5.6V with $V_S = 5.5V$**
- **Low Supply Current: 470 μ A/Amplifier (TYP)**
- **-40°C to +125°C Operating Temperature Range**
- **Available in Green TSSOP-14 and SOIC-14 Packages**

APPLICATIONS

Sensors
Audio
Active Filters
A/D Converters
Communications
Test Equipment
Cellular and Cordless Phones
Laptops and PDAs
Photodiode Amplification
Battery-Powered Instrumentation

PACKAGE/ORDERING INFORMATION

MODEL	PACKAGE DESCRIPTION	SPECIFIED TEMPERATURE RANGE	ORDERING NUMBER	PACKAGE MARKING	PACKING OPTION
SGM8634	TSSOP-14	-40°C to +125°C	SGM8634XTS14/TR	SGM8634 XTS14 XXXXX	Tape and Reel, 3000
	SOIC-14	-40°C to +125°C	SGM8634XS14/TR	SGM8634XS14 XXXXX	Tape and Reel, 2500

MARKING INFORMATION

NOTE: XXXXX = Date Code and Vendor Code.

XXXXX

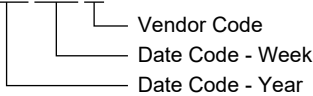

Green (RoHS & HSF): SG Micro Corp defines "Green" to mean Pb-Free (RoHS compatible) and free of halogen substances. If you have additional comments or questions, please contact your SGMICRO representative directly.

ABSOLUTE MAXIMUM RATINGS

Supply Voltage, +V_S to -V_S6V
 Input Common Mode Voltage Range
 (-V_S) - 0.3V to (+V_S) + 0.3V
 Junction Temperature+150°C
 Storage Temperature Range-65°C to +150°C
 Lead Temperature (Soldering, 10s)+260°C
 ESD Susceptibility
 HBM 1500V
 MM 400V

RECOMMENDED OPERATING CONDITIONS

Operating Temperature Range-40°C to +125°C

OVERSTRESS CAUTION

Stresses beyond those listed in Absolute Maximum Ratings may cause permanent damage to the device. Exposure to absolute maximum rating conditions for extended periods may affect reliability. Functional operation of the device at any conditions beyond those indicated in the Recommended Operating Conditions section is not implied.

ESD SENSITIVITY CAUTION

This integrated circuit can be damaged if ESD protections are not considered carefully. SGMICRO recommends that all integrated circuits be handled with appropriate precautions. Failure to observe proper handling and installation procedures can cause damage. ESD damage can range from subtle performance degradation to complete device failure. Precision integrated circuits may be more susceptible to damage because even small parametric changes could cause the device not to meet the published specifications.

DISCLAIMER

SG Micro Corp reserves the right to make any change in circuit design, or specifications without prior notice.

PIN CONFIGURATIONS

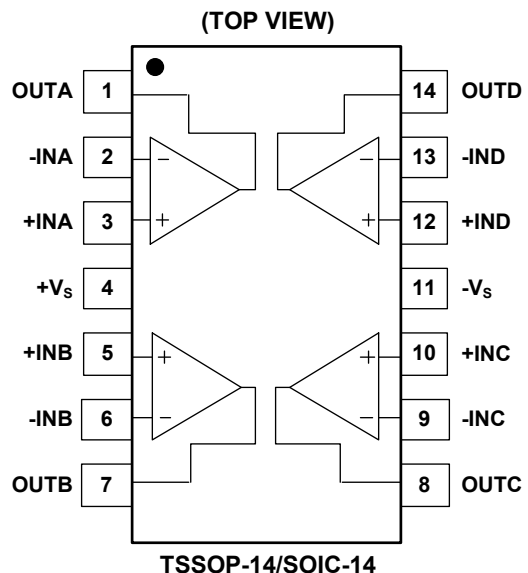

ELECTRICAL CHARACTERISTICS

(At $T_A = +25^\circ\text{C}$, $V_S = 5\text{V}$, $V_{CM} = V_S/2$ and $R_L = 600\Omega$, unless otherwise noted.)

PARAMETER	CONDITIONS	SGM8634							
		TYP	MIN/MAX OVER TEMPERATURE					UNITS	MIN/ MAX
		+25 $^\circ\text{C}$	+25 $^\circ\text{C}$	0 $^\circ\text{C}$ to +70 $^\circ\text{C}$	-40 $^\circ\text{C}$ to +85 $^\circ\text{C}$	-40 $^\circ\text{C}$ to +125 $^\circ\text{C}$			
Input Characteristics									
Input Offset Voltage (V_{OS})		0.8	3.5	3.9	4.3	4.6	mV	MAX	
Input Bias Current (I_B)		1					pA	TYP	
Input Offset Current (I_{OS})		1					pA	TYP	
Input Common Mode Voltage Range (V_{CM})	$V_S = 5.5\text{V}$	-0.1 to 5.6					V	TYP	
Common Mode Rejection Ratio (CMRR)	$V_S = 5.5\text{V}$, $V_{CM} = -0.1\text{V}$ to 4V	90	73	70	70	65	dB	MIN	
	$V_S = 5.5\text{V}$, $V_{CM} = -0.1\text{V}$ to 5.6V	83					dB	MIN	
Open-Loop Voltage Gain (A_{OL})	$R_L = 600\Omega$, $V_{OUT} = 0.15\text{V}$ to 4.85V	97	90	87	86	79	dB	MIN	
	$R_L = 10\text{k}\Omega$, $V_{OUT} = 0.05\text{V}$ to 4.95V	108					dB	MIN	
Input Offset Voltage Drift ($\Delta V_{OS}/\Delta T$)		2.4					$\mu\text{V}/^\circ\text{C}$	TYP	
Output Characteristics									
Output Voltage Swing from Rail	$R_L = 600\Omega$	0.1					V	TYP	
	$R_L = 10\text{k}\Omega$	0.015					V	TYP	
Output Current (I_{OUT})		53	49	45	40	35	mA	MIN	
Closed-Loop Output Impedance	$f = 200\text{kHz}$, $G = +1$	3					Ω	TYP	
Power Supply									
Operating Voltage Range			2.5	2.5	2.5	2.5	V	MIN	
			5.5	5.5	5.5	5.5	V	MAX	
Power Supply Rejection Ratio (PSRR)	$V_S = 2.5\text{V}$ to 5.5V , $V_{CM} = (-V_S) + 0.5\text{V}$	91	74	72	72	68	dB	MIN	
Quiescent Current/Amplifier (I_Q)	$I_{OUT} = 0$	470	650	727	750	815	μA	MAX	
Dynamic Performance									
Gain-Bandwidth Product (GBP)	$R_L = 10\text{k}\Omega$	6					MHz	TYP	
Phase Margin (ϕ_O)		60					degrees	TYP	
Full Power Bandwidth (BW_P)	< 1% distortion, $R_L = 600\Omega$	250					kHz	TYP	
Slew Rate (SR)	$G = +1$, 2V Step, $R_L = 10\text{k}\Omega$	3.7					$\text{V}/\mu\text{s}$	TYP	
Settling Time to 0.1% (t_S)	$G = +1$, 2V Step, $R_L = 600\Omega$	2.1					μs	TYP	
Overload Recovery Time	$V_{IN} \cdot G = V_S$, $R_L = 600\Omega$	0.9					μs	TYP	
Noise Performance									
Input Voltage Noise Density (e_n)	$f = 1\text{kHz}$	12					$\text{nV}/\sqrt{\text{Hz}}$	TYP	
Input Current Noise Density (i_n)	$f = 1\text{kHz}$	3					$\text{fA}/\sqrt{\text{Hz}}$	TYP	

TYPICAL PERFORMANCE CHARACTERISTICS

At $T_A = +25^\circ\text{C}$, $V_{CM} = V_S/2$ and $R_L = 600\Omega$, unless otherwise noted.

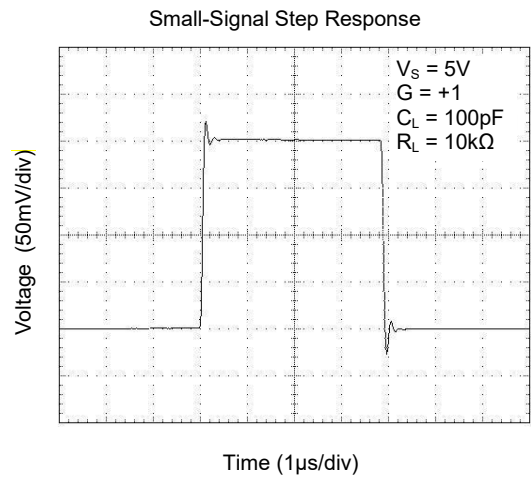
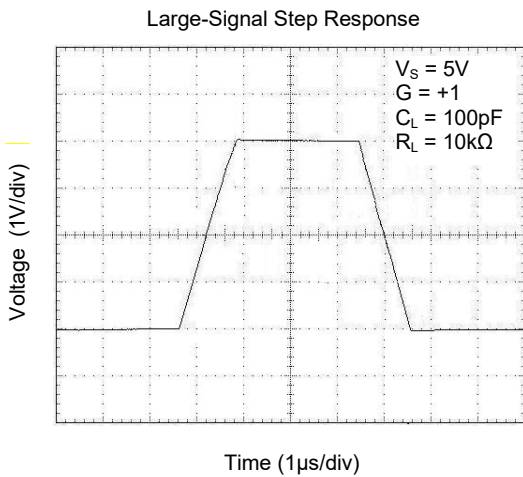
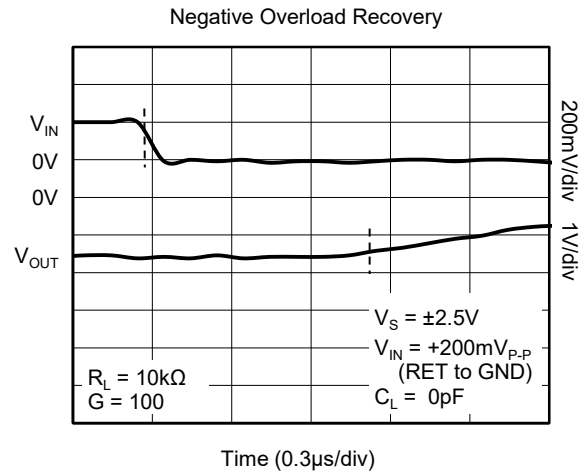
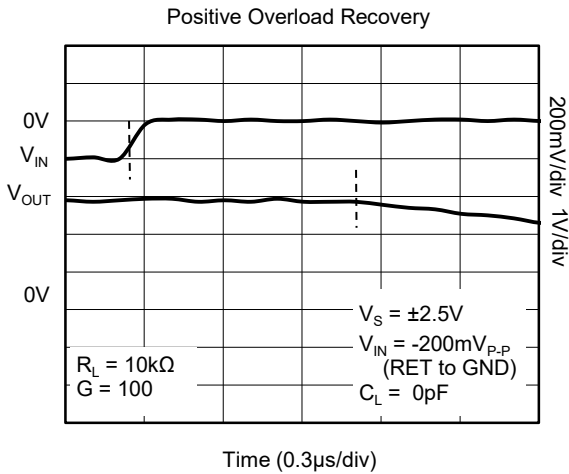
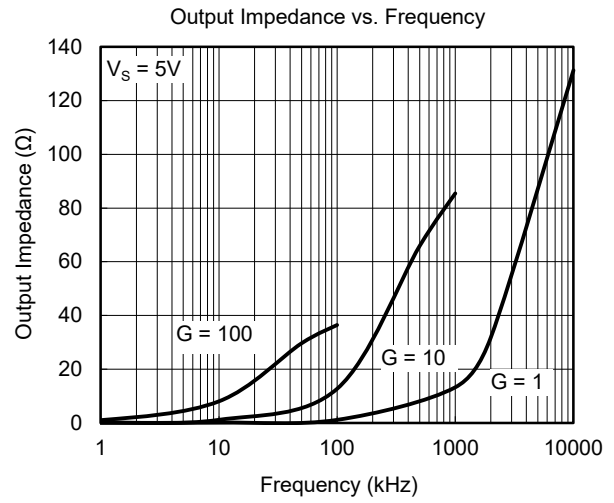
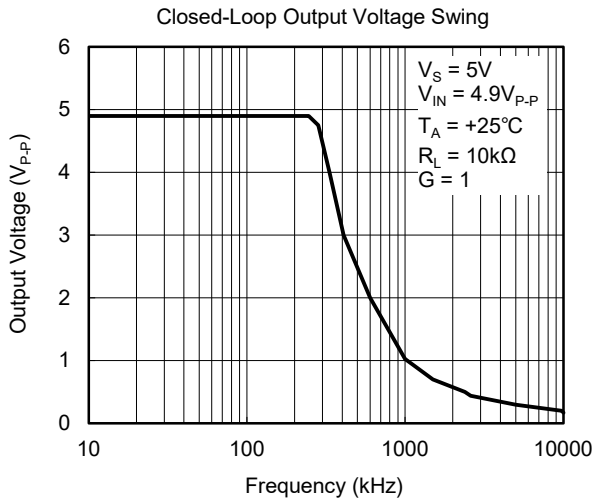

TYPICAL PERFORMANCE CHARACTERISTICS (continued)

At $T_A = +25^\circ\text{C}$, $V_{CM} = V_S/2$ and $R_L = 600\Omega$, unless otherwise noted.

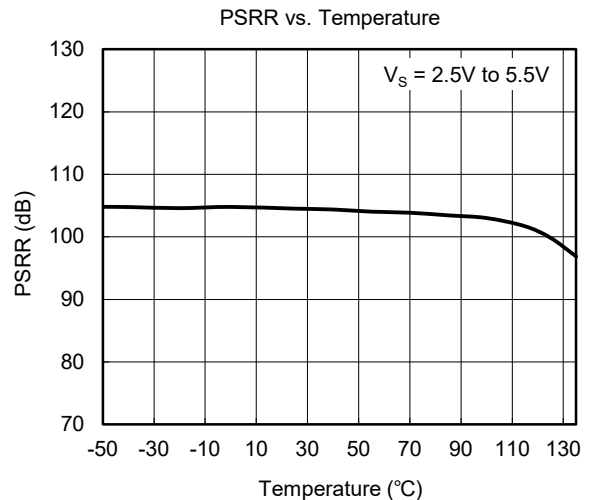
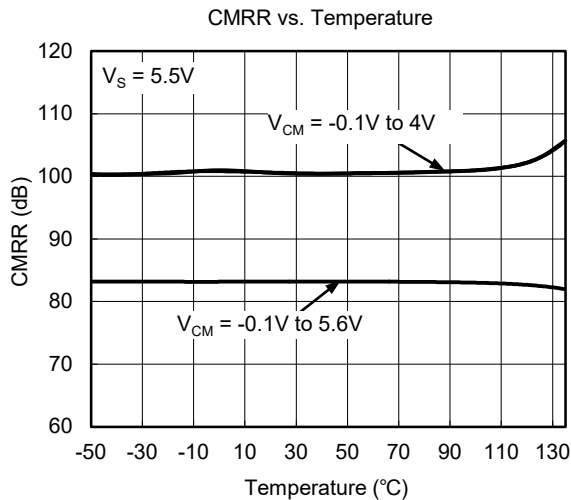
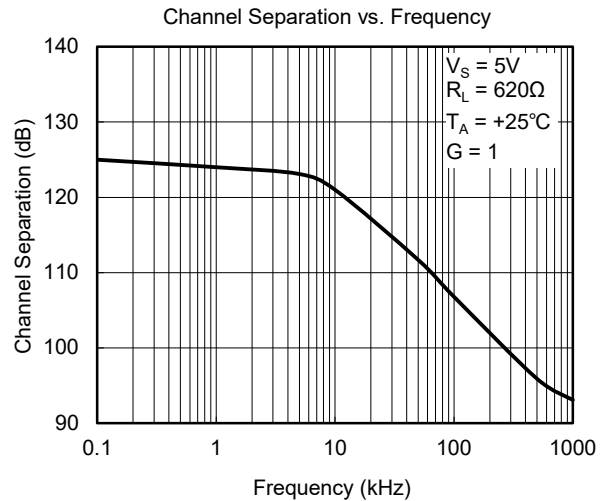
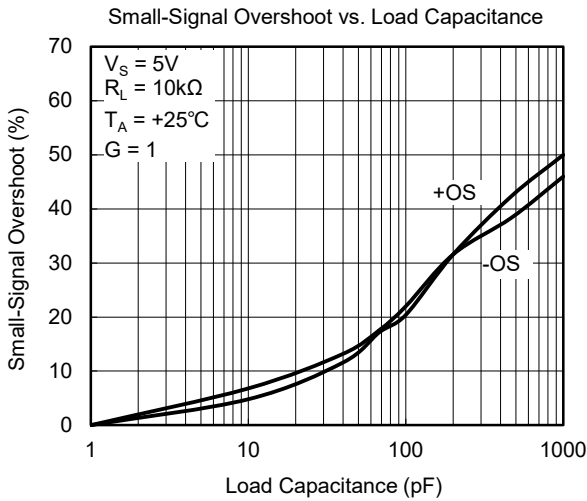
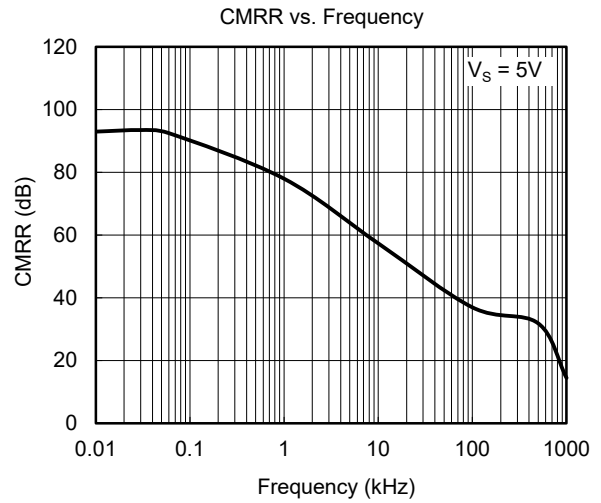
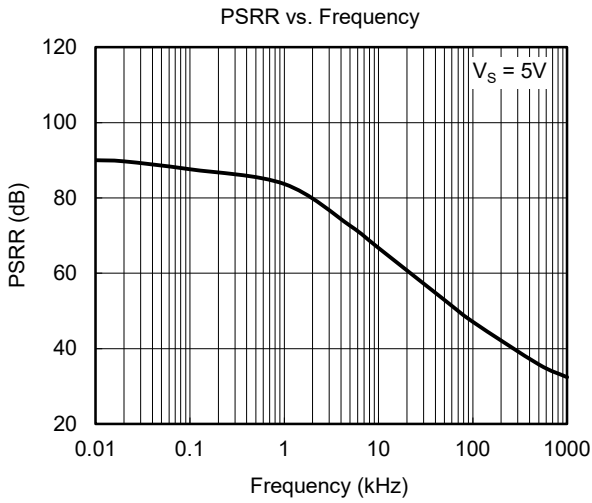

TYPICAL PERFORMANCE CHARACTERISTICS (continued)

At $T_A = +25^\circ\text{C}$, $V_{CM} = V_S/2$ and $R_L = 600\Omega$, unless otherwise noted.

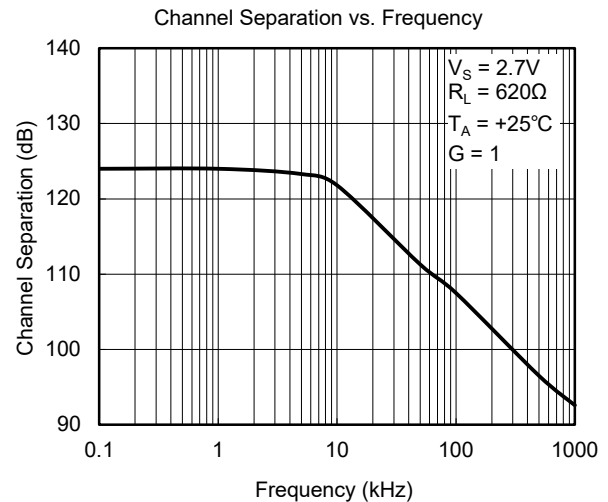
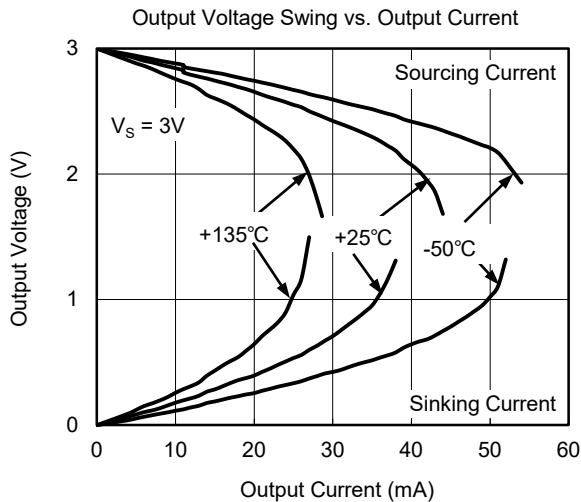
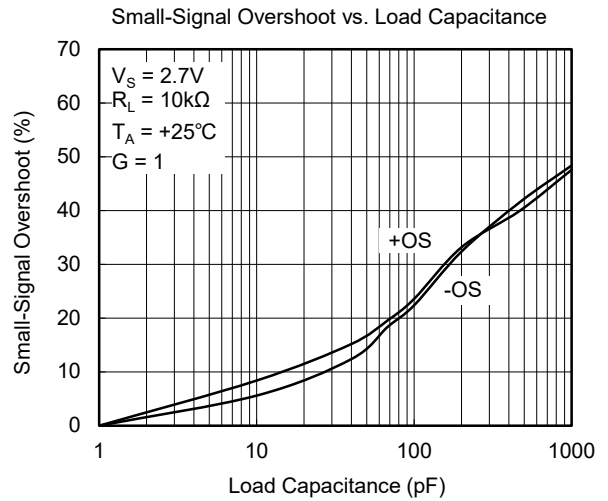
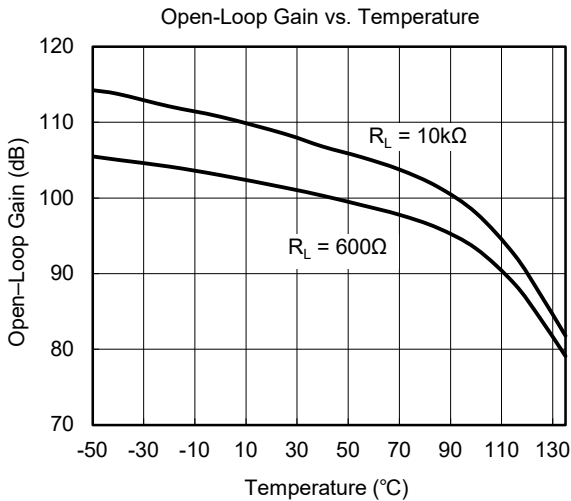
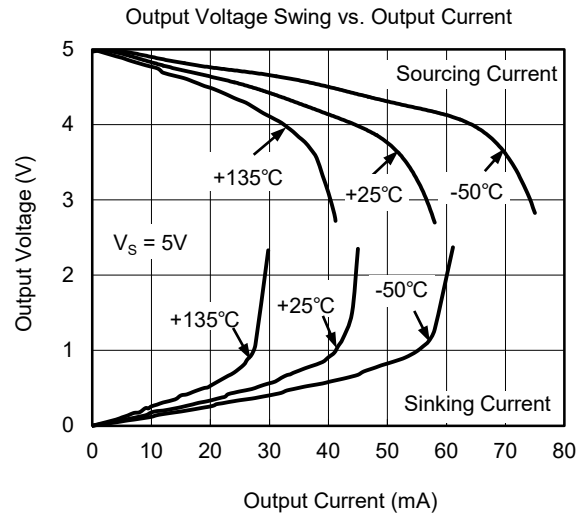
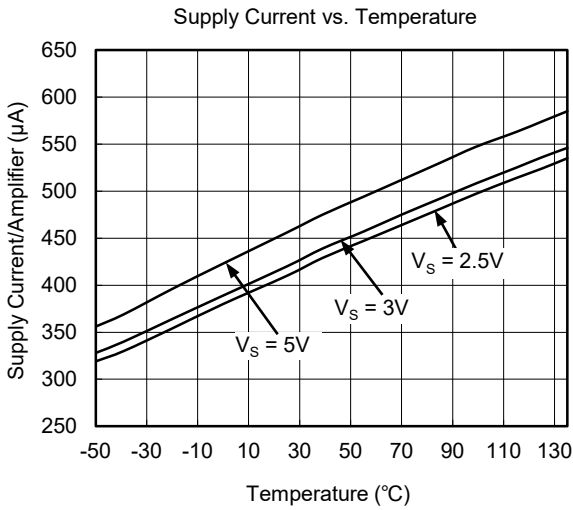

TYPICAL PERFORMANCE CHARACTERISTICS (continued)

At $T_A = +25^\circ\text{C}$, $V_{CM} = V_S/2$ and $R_L = 600\Omega$, unless otherwise noted.

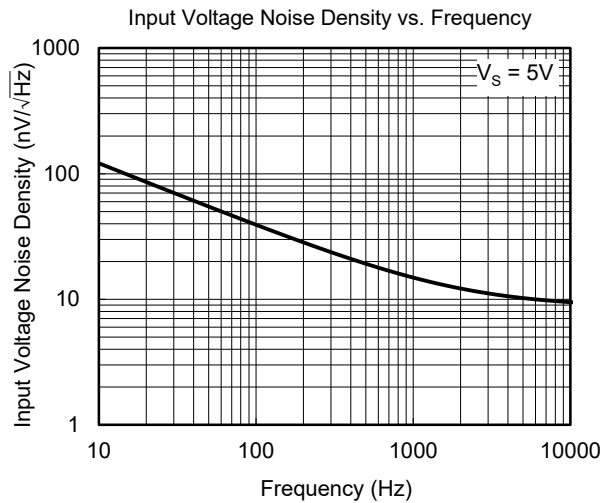
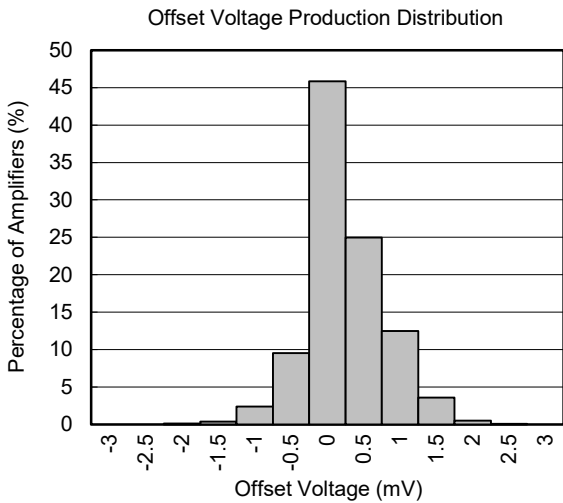
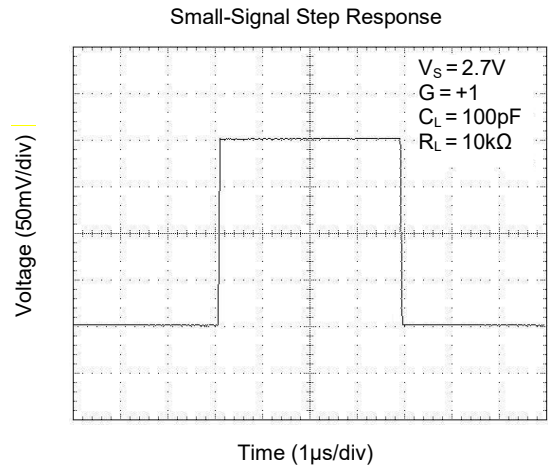
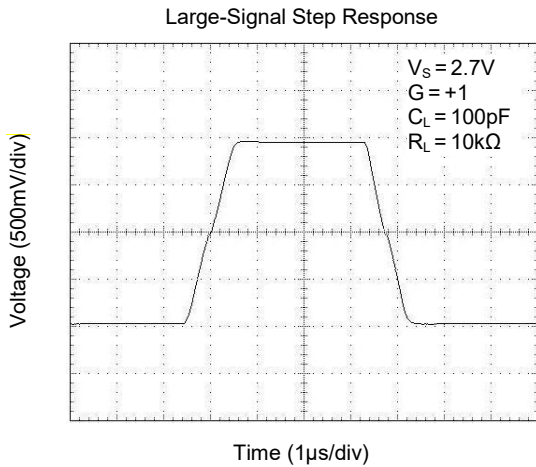
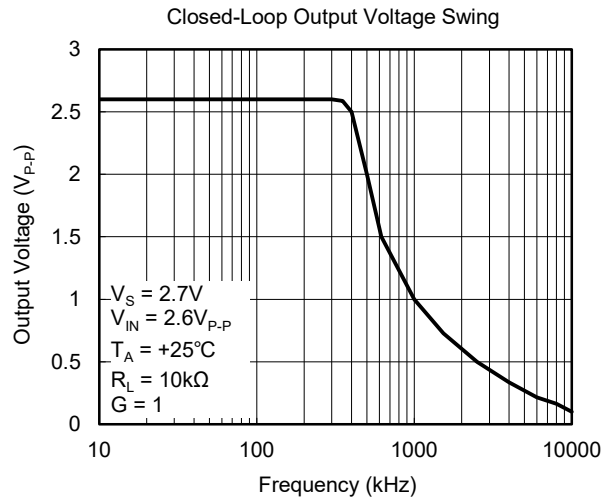
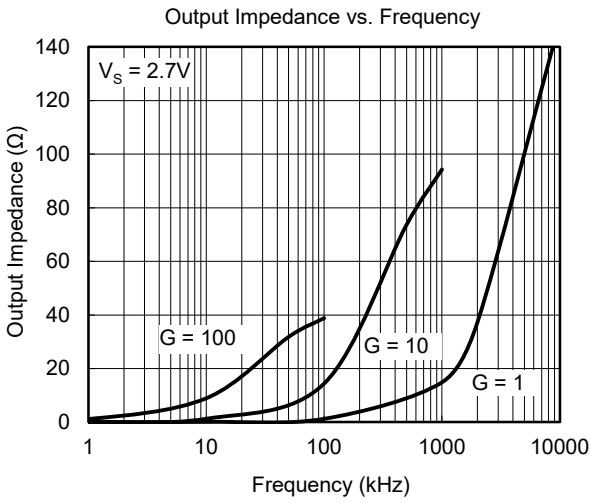

APPLICATION INFORMATION

Rail-to-Rail Input

When SGM8634 works at the power supply between 2.5V and 5.5V, the input common mode voltage range is from $(-V_S) - 0.1V$ to $(+V_S) + 0.1V$. In Figure 1, the ESD diodes between the inputs and the power supply rails will clamp the input voltage not to exceed the rails.

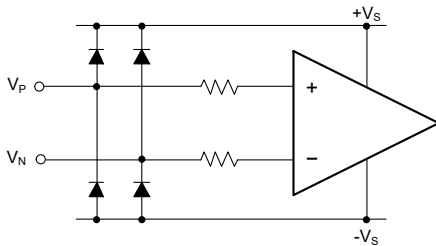

Figure 1. Input Equivalent Circuit

Rail-to-Rail Output

The SGM8634 supports rail-to-rail output operation. In single power supply application, for example, when $+V_S = 5V$, $-V_S = GND$, 10kΩ load resistor is tied from OUT pin to ground, the typical output swing range is from 0.015V to 4.985V.

Driving Capacitive Loads

The SGM8634 is designed for unity-gain stable for capacitive load up to 1000pF. If greater capacitive load must be driven in application, the circuit in Figure 2 can be used. In this circuit, the IR drop voltage generated by R_{ISO} is compensated by feedback loop.

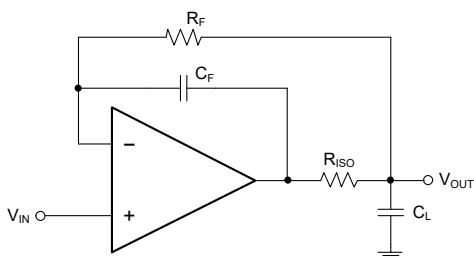

Figure 2. Circuit to Drive Heavy Capacitive Load

Power Supply Decoupling and Layout

A clean and low noise power supply is very important in amplifier circuit design, besides of input signal noise, the power supply is one of important source of noise to the amplifier through $+V_S$ and $-V_S$ pins. Power supply bypassing is an effective method to clear up the noise at power supply, and the low impedance path to ground of decoupling capacitor will bypass the noise to GND. In application, 10µF ceramic capacitor paralleled with 0.1µF or 0.01µF ceramic capacitor is used in Figure 3. The ceramic capacitors should be placed as close as possible to $+V_S$ and $-V_S$ power supply pins.

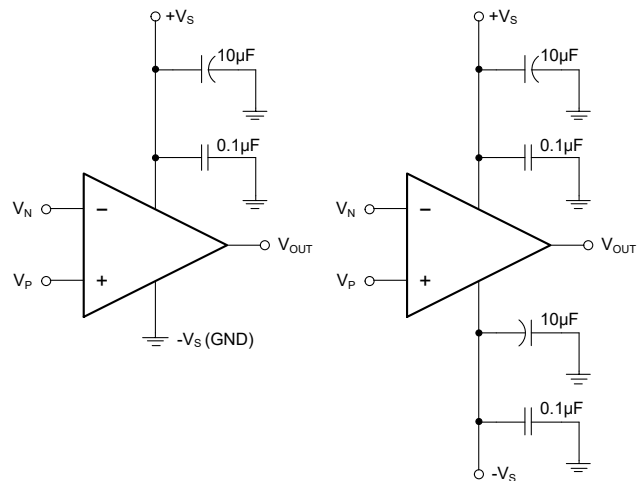

Figure 3. Amplifier Power Supply Bypassing

Grounding

In low speed application, one node grounding technique is the simplest and most effective method to eliminate the noise generated by grounding. In high speed application, the general method to eliminate noise is to use a complete ground plane technique, and the whole ground plane will help distribute heat and reduce EMI noise pickup.

Reduce Input-to-Output Coupling

To reduce the input-to-output coupling, the input traces must be placed as far away from the power supply or output traces as possible. The sensitive trace must not be placed in parallel with the noisy trace in same layer. They must be placed perpendicularly in different layers to reduce the crosstalk. These PCB layout techniques will help to reduce unwanted positive feedback and noise.

APPLICATION INFORMATION (continued)

Typical Application Circuits

Difference Amplifier

The circuit in Figure 4 is a design example of classical difference amplifier. If $R_4/R_3 = R_2/R_1$, then $V_{OUT} = (V_P - V_N) \times R_2/R_1 + V_{REF}$.

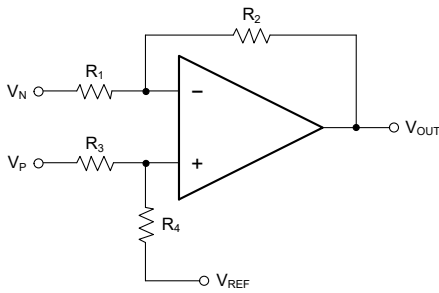

Figure 4. Difference Amplifier

High Input Impedance Difference Amplifier

The circuit in Figure 5 is a design example of high input impedance difference amplifier, the added amplifiers at the input are used to increase the input impedance and eliminate drawback of low input impedance in Figure 4.

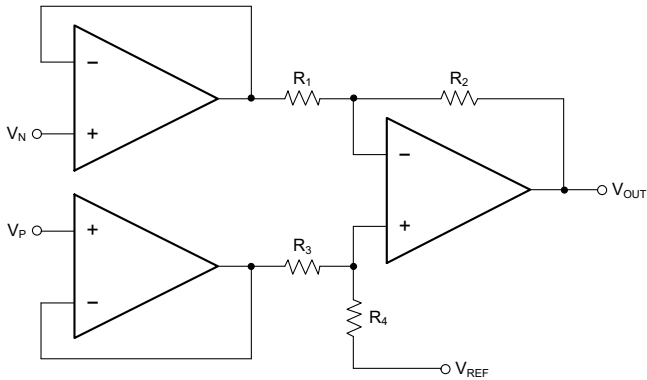

Figure 5. High Input Impedance Difference Amplifier

Active Low-Pass Filter

The circuit in Figure 6 is a design example of active low-pass filter, the DC gain is equal to $-R_2/R_1$ and the -3dB corner frequency is equal to $1/2\pi R_2 C$. In this design, the filter bandwidth must be less than the bandwidth of the amplifier, the resistor values must be selected as low as possible to reduce ringing or oscillation generated by the parasitic parameters in PCB layout.

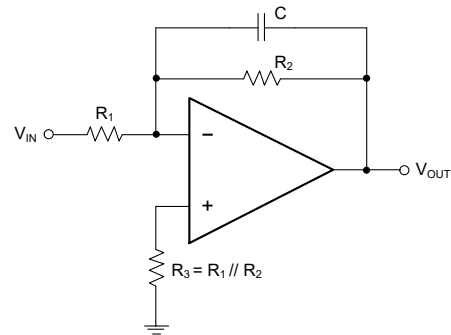

Figure 6. Active Low-Pass Filter

REVISION HISTORY

NOTE: Page numbers for previous revisions may differ from page numbers in the current version.

DECEMBER 2015 – REV.C.1 to REV.C.2	Page
New version.....	All

February 2015 – REV.C to REV.C.1	Page
Changed Package Outline Dimensions section	17, 18

PACKAGE OUTLINE DIMENSIONS

TSSOP-14

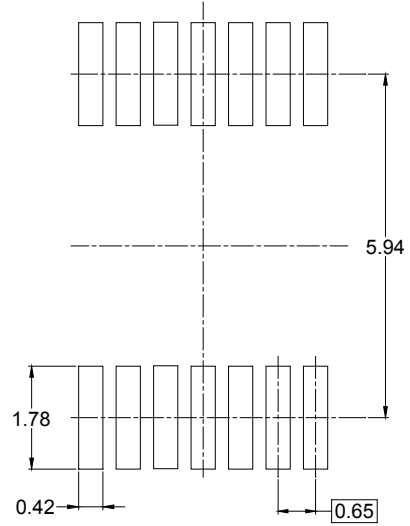
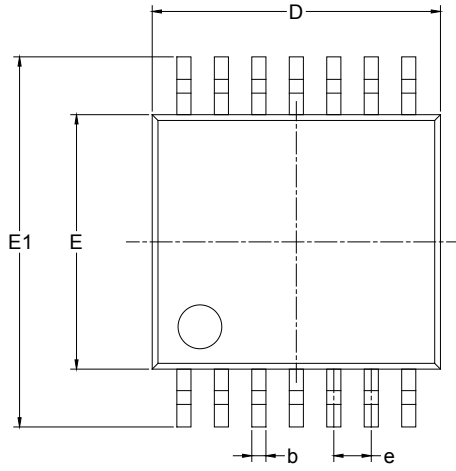

RECOMMENDED LAND PATTERN (Unit: mm)

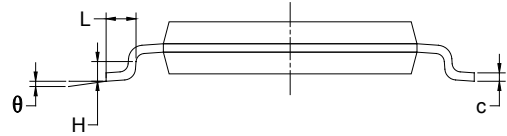
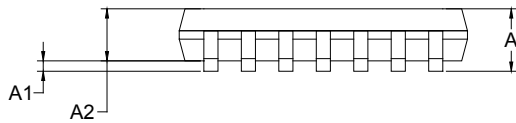

Symbol	Dimensions In Millimeters		Dimensions In Inches	
	MIN	MAX	MIN	MAX
A		1.200		0.047
A1	0.050	0.150	0.002	0.006
A2	0.800	1.050	0.031	0.041
b	0.190	0.300	0.007	0.012
c	0.090	0.200	0.004	0.008
D	4.860	5.100	0.191	0.201
E	4.300	4.500	0.169	0.177
E1	6.250	6.550	0.246	0.258
e	0.650 BSC		0.026 BSC	
L	0.500	0.700	0.02	0.028
H	0.25 TYP		0.01 TYP	
θ	1°	7°	1°	7°

PACKAGE OUTLINE DIMENSIONS

SOIC-14

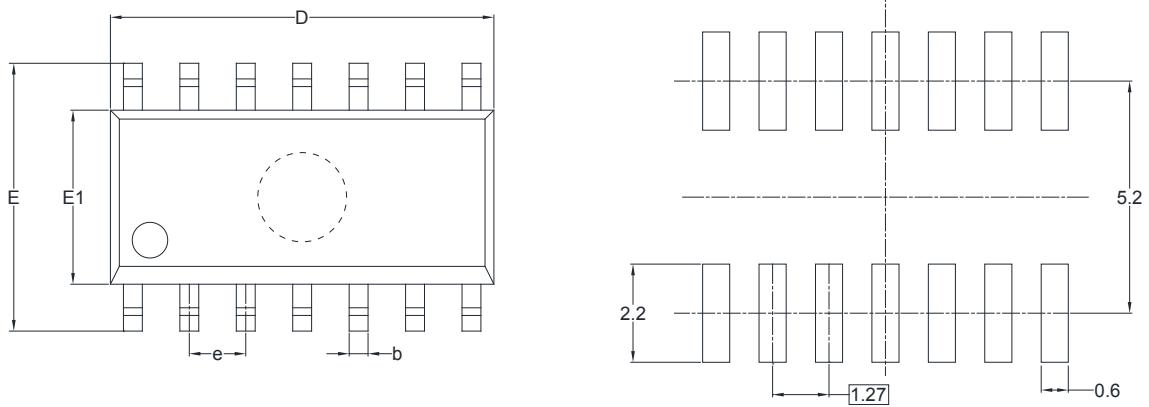

RECOMMENDED LAND PATTERN (Unit: mm)

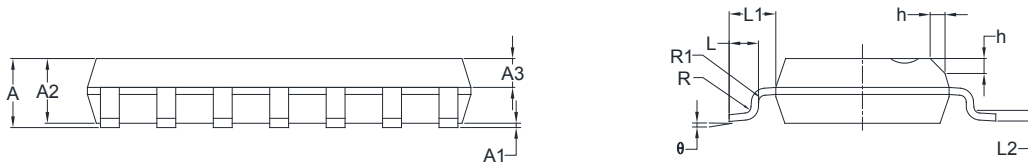

Symbol	Dimensions In Millimeters		Dimensions In Inches	
	MIN	MAX	MIN	MAX
A	1.35	1.75	0.053	0.069
A1	0.10	0.25	0.004	0.010
A2	1.25	1.65	0.049	0.065
A3	0.55	0.75	0.022	0.030
b	0.36	0.49	0.014	0.019
D	8.53	8.73	0.336	0.344
E	5.80	6.20	0.228	0.244
E1	3.80	4.00	0.150	0.157
e	1.27 BSC		0.050 BSC	
L	0.45	0.80	0.018	0.032
L1	1.04 REF		0.040 REF	
L2	0.25 BSC		0.01 BSC	
R	0.07		0.003	
R1	0.07		0.003	
h	0.30	0.50	0.012	0.020
θ	0°	8°	0°	8°

TAPE AND REEL INFORMATION

REEL DIMENSIONS



TAPE DIMENSIONS



NOTE: The picture is only for reference. Please make the object as the standard.

KEY PARAMETER LIST OF TAPE AND REEL

Package Type	Reel Diameter	Reel Width W1 (mm)	A0 (mm)	B0 (mm)	K0 (mm)	P0 (mm)	P1 (mm)	P2 (mm)	W (mm)	Pin1 Quadrant
TSSOP-14	13"	12.4	6.95	5.60	1.20	4.0	8.0	2.0	12.0	Q1
SOIC-14	13"	16.4	6.60	9.30	2.10	4.0	8.0	2.0	16.0	Q1

DD0001

PACKAGE INFORMATION

CARTON BOX DIMENSIONS



NOTE: The picture is only for reference. Please make the object as the standard.

KEY PARAMETER LIST OF CARTON BOX

Reel Type	Length (mm)	Width (mm)	Height (mm)	Pizza/Carton
13"	386	280	370	5

DD0002