



SGM8968-1/SGM8968-2/SGM8968-4

1.6mA, 10MHz, High Precision, Low Noise, Rail-to-Rail I/O, CMOS Operational Amplifiers

GENERAL DESCRIPTION

The SGM8968-1/2/4 are a family of single, dual and quad rail-to-rail input and output operational amplifiers, which are optimized for low voltage, low noise and high precision operation. These devices can operate from 1.8V to 5.5V single supply, while consuming only 1.6mA quiescent current per amplifier at 5.5V.

The SGM8968-1/2/4 feature a 240 μ V maximum input offset. They exhibit a high gain-bandwidth product of 10MHz and a slew rate of 20V/ μ s. These specifications make the operational amplifiers appropriate for various applications.

The SGM8968-1 is available in Green SOT-23-5 and SOIC-8 packages. The SGM8968-2 is available in Green SOIC-8 and MSOP-8 packages. The SGM8968-4 is available in Green SOIC-14 and TSSOP-14 packages. They are specified over the extended industrial temperature range (-40°C to +125°C).

FEATURES

- **Input Offset Voltage: 240 μ V (MAX)**
- **High Gain-Bandwidth Product: 10MHz**
- **High Slew Rate: 20V/ μ s**
- **Settling Time to 0.1% with 2V Step: 280ns**
- **Overload Recovery Time: 100ns**
- **Low Noise: 8nV/ $\sqrt{\text{Hz}}$ at 10kHz**
- **Rail-to-Rail Input and Output**
- **Supply Voltage Range: 1.8V to 5.5V**
- **Input Voltage Range: -0.1V to 5.6V with $V_S = 5.5V$**
- **Low Power: 1.6mA/Amplifier (TYP) Supply Current**
- **-40°C to +125°C Operating Temperature Range**
- **Small Packaging:**
 - SGM8968-1 Available in Green SOT-23-5 and SOIC-8 Packages**
 - SGM8968-2 Available in Green SOIC-8 and MSOP-8 Packages**
 - SGM8968-4 Available in Green SOIC-14 and TSSOP-14 Packages**

APPLICATIONS

Sensor
Audio
Active Filter
A/D Converter
Communication
Test Equipment
Cellular and Cordless Phone
Laptop and PDA
Photodiode Amplification
Battery-Powered Instrumentation

PIN CONFIGURATIONS

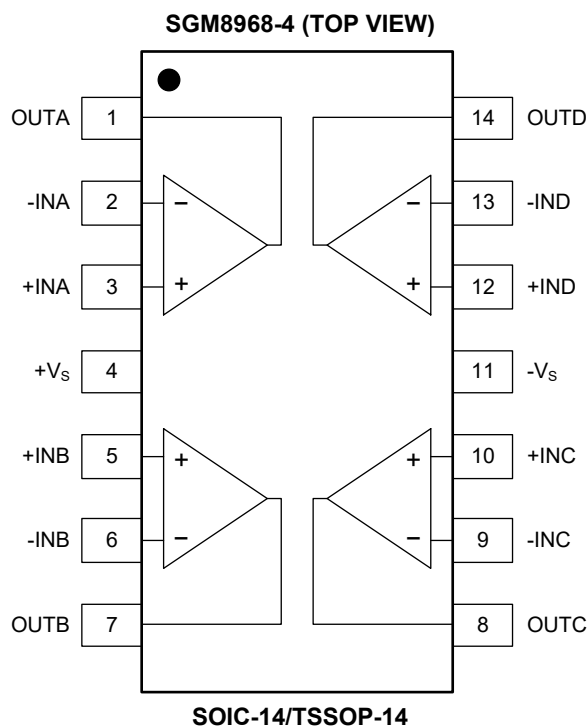
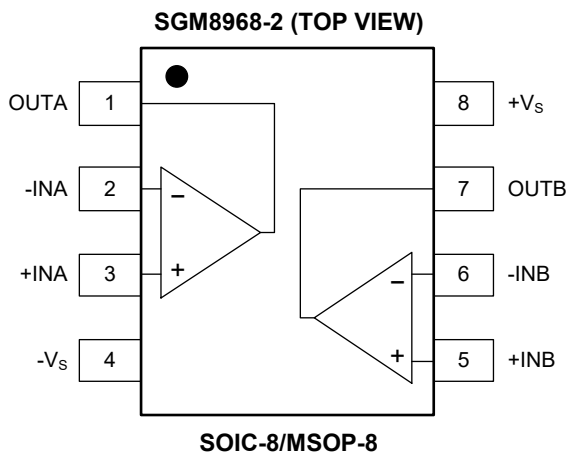
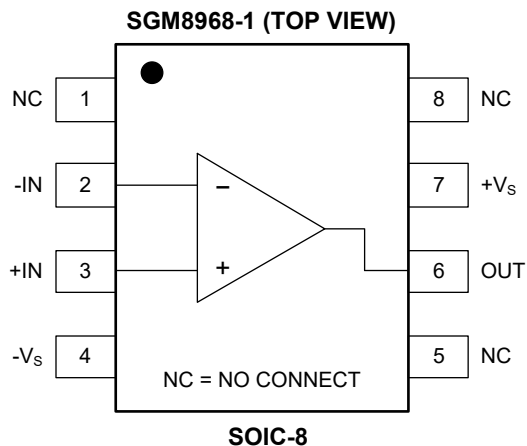
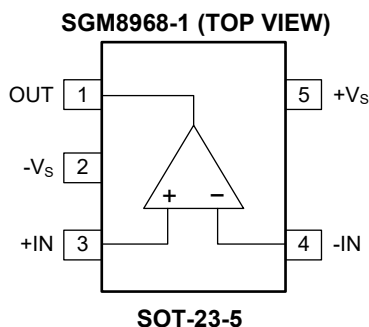

ELECTRICAL CHARACTERISTICS

(At $T_A = +25^\circ\text{C}$, $V_S = 1.8\text{V}$ to 5.5V or $\pm 0.9\text{V}$ to $\pm 2.75\text{V}$, $V_{CM} = V_S/2$ and $R_L = 10\text{k}\Omega$ connected to $V_S/2$, Full = -40°C to $+125^\circ\text{C}$, unless otherwise noted.)

PARAMETER	SYMBOL	CONDITIONS	TEMP	MIN	TYP	MAX	UNITS
Input Characteristics							
Input Offset Voltage	V_{OS}		+25°C		50	240	μV
			Full			700	
Input Offset Voltage Drift	$\Delta V_{OS}/\Delta T$	$V_S = \pm 2.75\text{V}$	Full		1		$\mu\text{V}/^\circ\text{C}$
Input Bias Current	I_B		+25°C		6	120	pA
			Full			6500	
Input Offset Current	I_{OS}		+25°C		6	120	pA
			Full			1500	
Input Common Mode Voltage Range	V_{CM}		Full	$(-V_S) - 0.1$		$(+V_S) + 0.1$	V
Common Mode Rejection Ratio	CMRR	$V_S = 5.5\text{V}$, $V_{CM} = -0.1\text{V}$ to 5.6V	+25°C	84	95		dB
			Full	81			
		$V_S = 1.8\text{V}$, $V_{CM} = -0.1\text{V}$ to 1.9V	+25°C	75	94		
			Full	71			
Open-Loop Voltage Gain	A_{OL}	$V_S = \pm 0.9\text{V}$, $R_L = 1\text{k}\Omega$, $(-V_S) + 0.25\text{V} < V_{OUT} < (+V_S) - 0.25\text{V}$	+25°C	90	117		dB
			Full	87			
		$V_S = \pm 2.75\text{V}$, $R_L = 1\text{k}\Omega$, $(-V_S) + 0.25\text{V} < V_{OUT} < (+V_S) - 0.25\text{V}$	+25°C	102	130		
			Full	99			
		$V_S = \pm 0.9\text{V}$, $R_L = 10\text{k}\Omega$, $(-V_S) + 0.15\text{V} < V_{OUT} < (+V_S) - 0.15\text{V}$	+25°C	93	117		
			Full	90			
		$V_S = \pm 2.75\text{V}$, $R_L = 10\text{k}\Omega$, $(-V_S) + 0.15\text{V} < V_{OUT} < (+V_S) - 0.15\text{V}$	+25°C	102	128		
			Full	99			
Output Characteristics							
Output Voltage Swing from Rail	V_{OUT}	$V_S = 5.5\text{V}$, $R_L = 1\text{k}\Omega$	+25°C		60	80	mV
			Full			88	
		$V_S = 5.5\text{V}$, $R_L = 10\text{k}\Omega$	+25°C		8	13	
			Full			15	
Output Current (I_{OUT})	I_{OUT}	$V_S = 5.5\text{V}$	+25°C	31	80		mA
			Full	19			
Power Supply							
Operating Voltage Range	V_S		Full	1.8		5.5	V
Power Supply Rejection Ratio	PSRR	$V_S = 1.8\text{V}$ to 5.5V , $V_{CM} = (-V_S) + 0.5\text{V}$	+25°C	89	110		dB
			Full	86			
Quiescent Current/Amplifier	I_Q	$I_{OUT} = 0$	+25°C		1.6	2.1	mA
			Full			2.2	
Dynamic Performance							
Gain-Bandwidth Product	GBP	$V_S = 5\text{V}$	+25°C		10		MHz
Phase Margin	ϕ_O	$V_S = 5\text{V}$	+25°C		60		°
Slew Rate	SR	$V_S = 5\text{V}$, $G = +1$, 2V output step	+25°C		20		V/ μs
Settling Time to 0.1%	t_S	$V_S = 5\text{V}$, $G = +1$, 2V output step	+25°C		280		ns
Overload Recovery Time		$V_S = 5\text{V}$, $V_{IN} \times G = V_S$	+25°C		100		ns
Total Harmonic Distortion + Noise	THD+N	$V_{OUT} = 4V_{P-P}$, $G = +1$, $f = 10\text{kHz}$, $BW = 22\text{Hz}$ to 80kHz	+25°C		0.0005		%
Noise Performance							
Input Voltage Noise Density	e_n	$f = 1\text{kHz}$	+25°C		18		$\text{nV}/\sqrt{\text{Hz}}$
		$f = 10\text{kHz}$	+25°C		8		

TYPICAL PERFORMANCE CHARACTERISTICS

At $T_A = +25^\circ\text{C}$, $V_S = \pm 2.75\text{V}$ and $R_L = 10\text{k}\Omega$, unless otherwise noted.

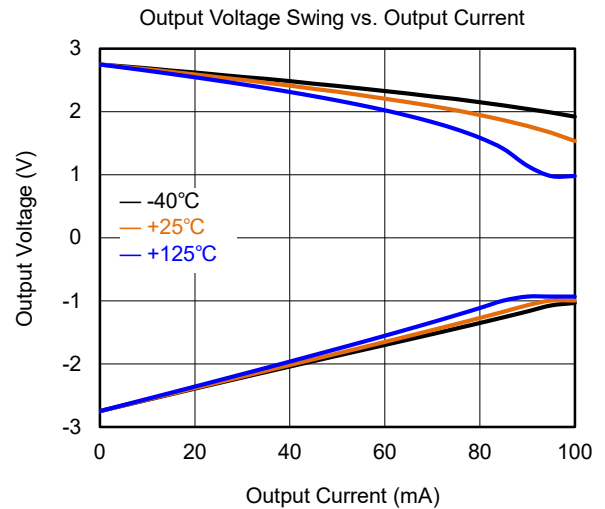
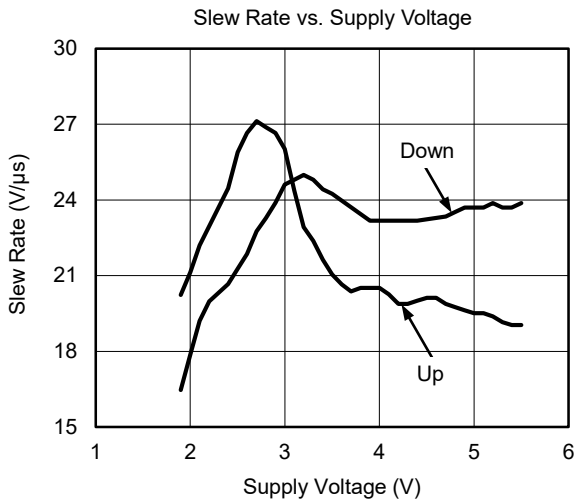
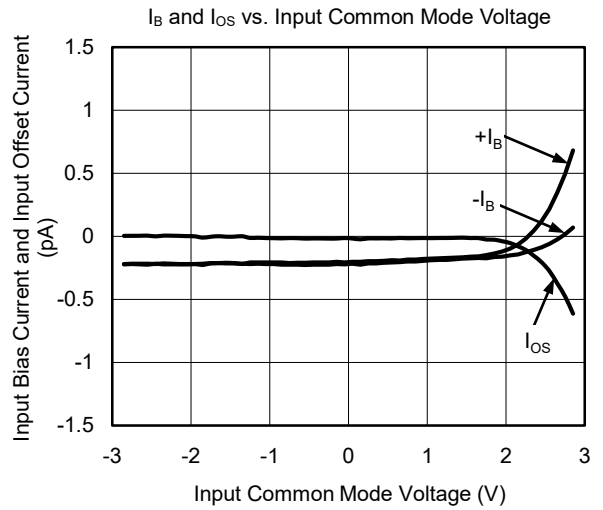
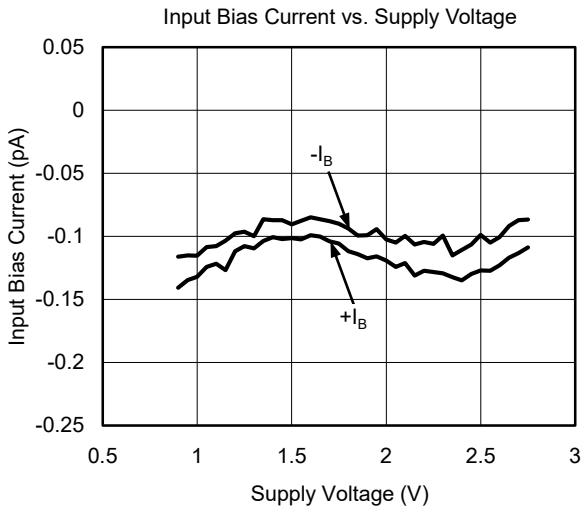
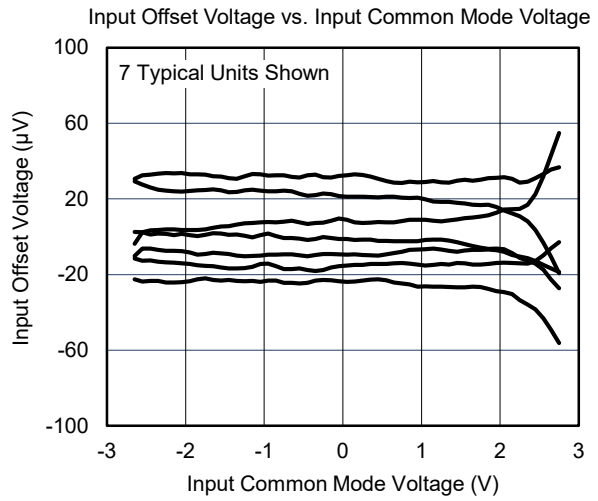
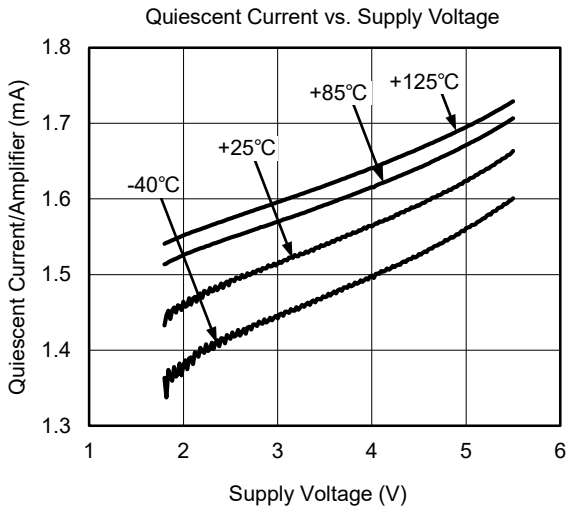

TYPICAL PERFORMANCE CHARACTERISTICS (continued)

At $T_A = +25^\circ\text{C}$, $V_S = \pm 2.75\text{V}$ and $R_L = 10\text{k}\Omega$, unless otherwise noted.

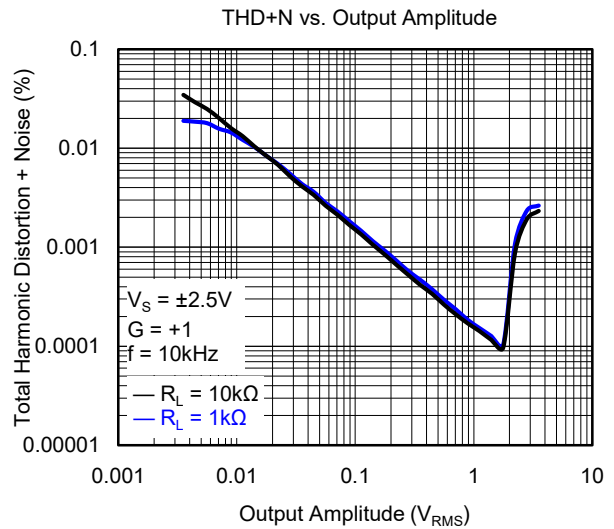
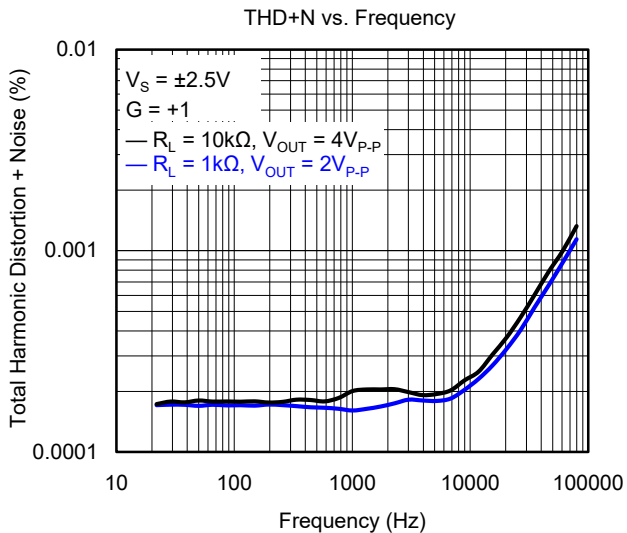
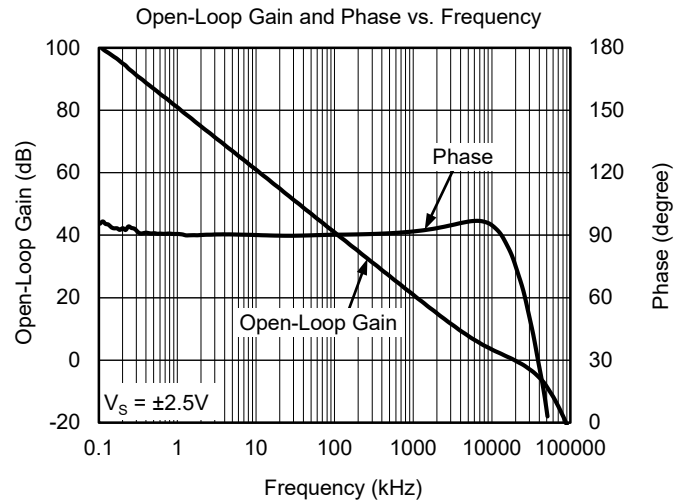
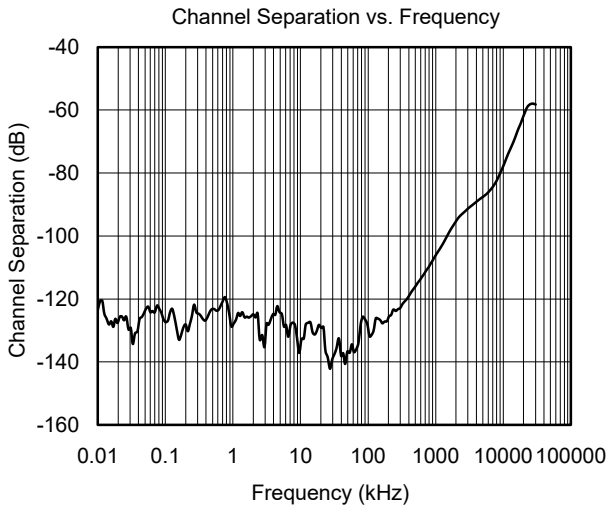
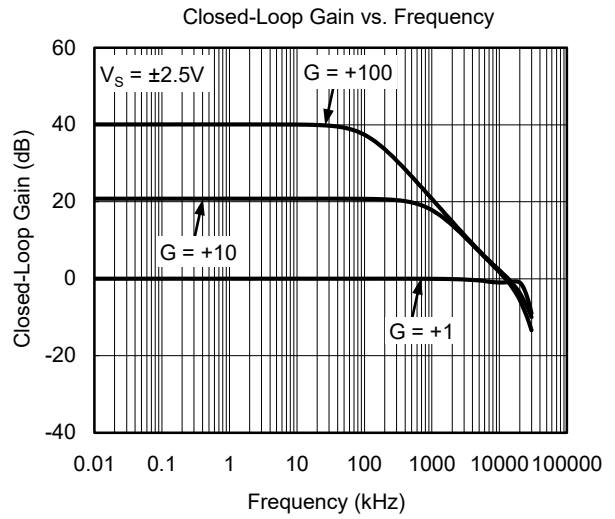
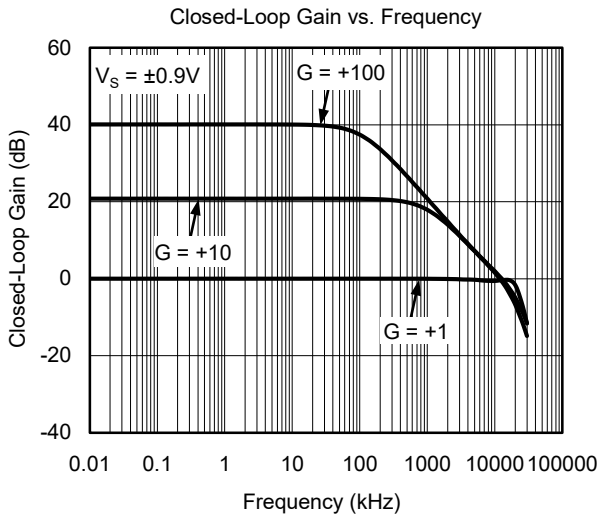

TYPICAL PERFORMANCE CHARACTERISTICS (continued)

At $T_A = +25^\circ\text{C}$, $V_S = \pm 2.75\text{V}$ and $R_L = 10\text{k}\Omega$, unless otherwise noted.

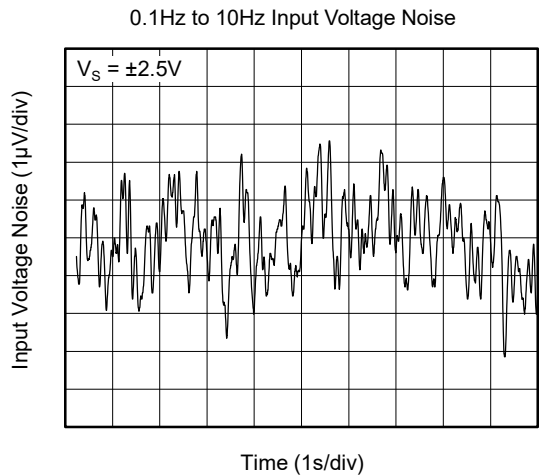
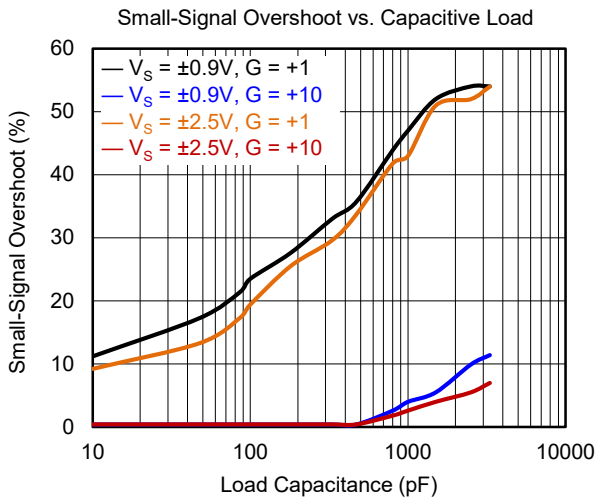
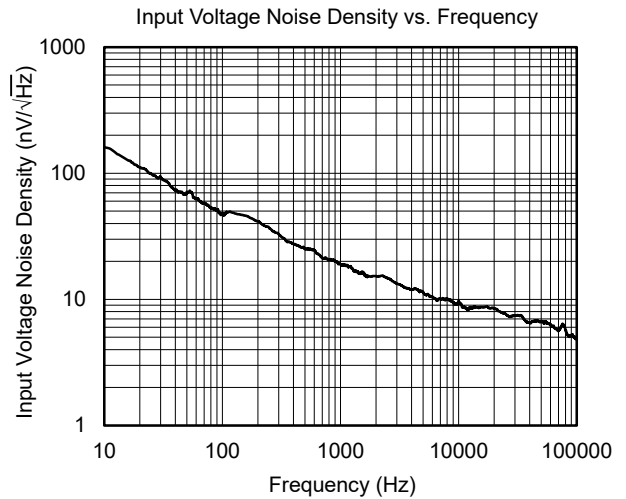
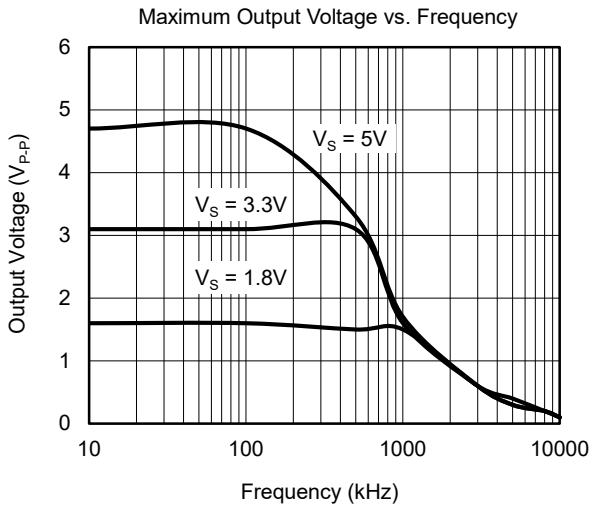
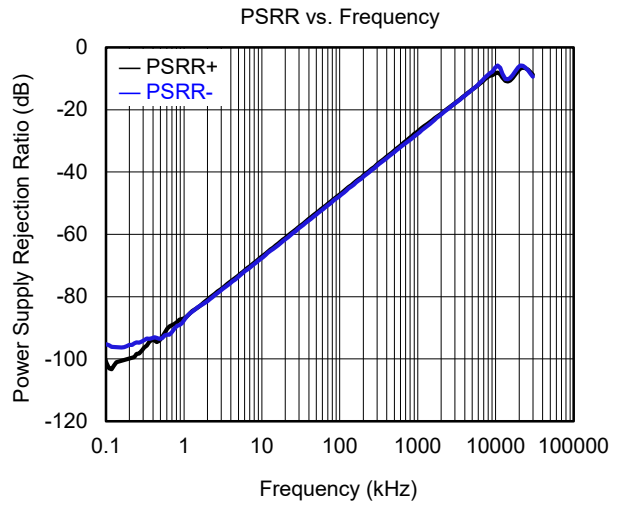
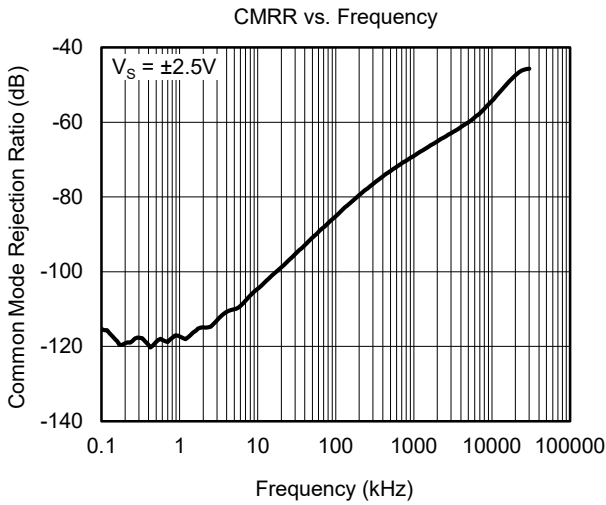

TYPICAL PERFORMANCE CHARACTERISTICS (continued)

At $T_A = +25^\circ\text{C}$, $V_S = \pm 2.75\text{V}$ and $R_L = 10\text{k}\Omega$, unless otherwise noted.

Small-Signal Step Response

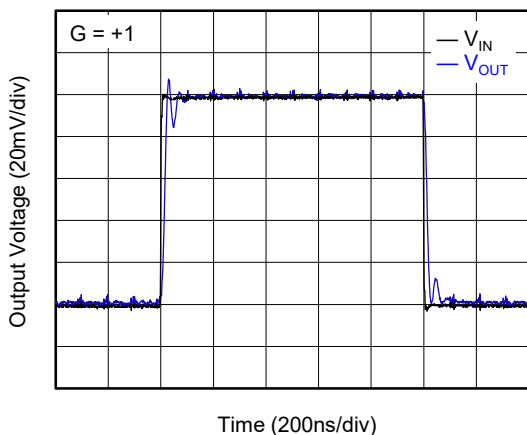

Small-Signal Step Response

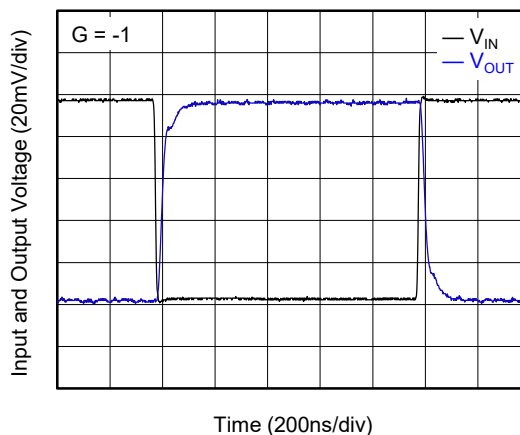

Large-Signal Step Response

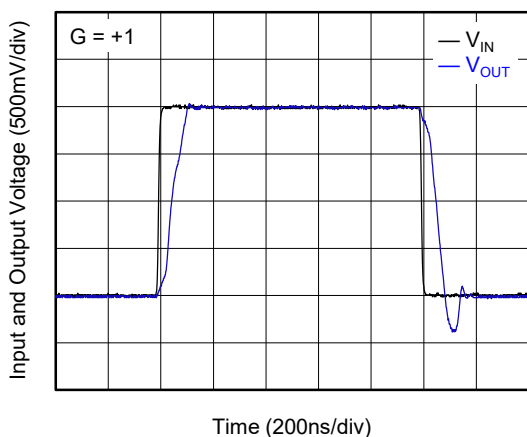

No Phase Reversal

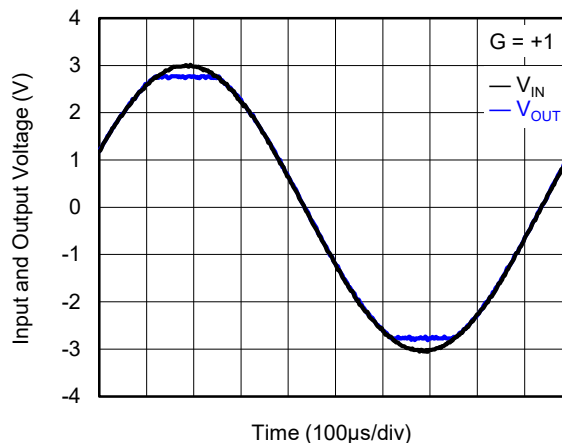

Input Offset Voltage Production Distribution

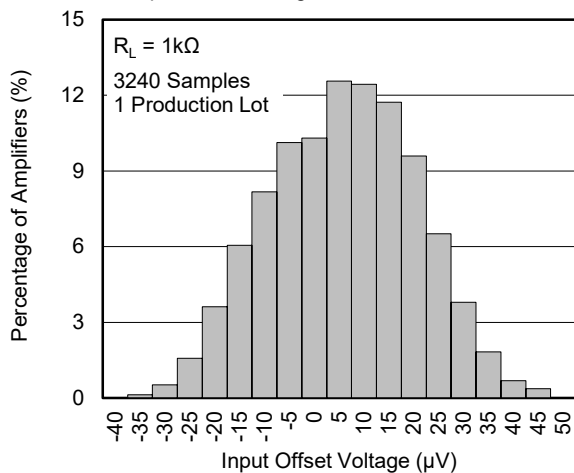

Input Offset Voltage Drift Distribution

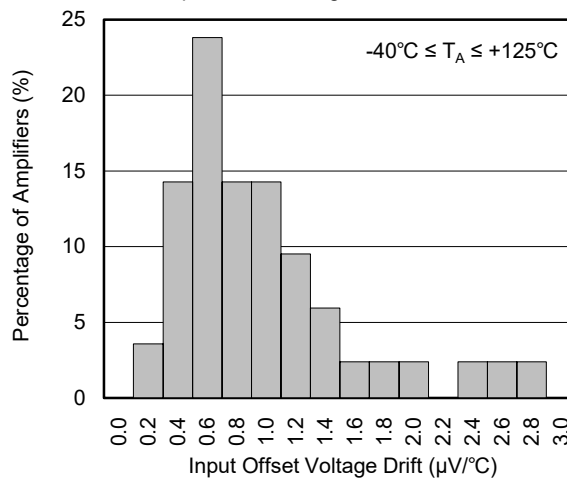

APPLICATION INFORMATION

Rail-to-Rail Input

When SGM8968-1/2/4 work at the power supply between 1.8V and 5.5V, the input common mode voltage range is from $(-V_S) - 0.1V$ to $(+V_S) + 0.1V$. In Figure 1, the ESD diodes between the inputs and the power supply rails will clamp the input voltage not to exceed the rails.

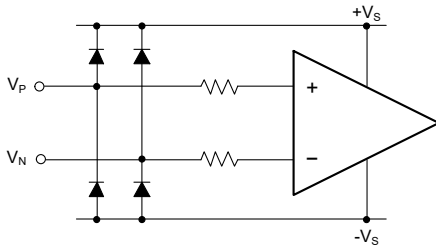

Figure 1. Input Equivalent Circuit

Input Current-Limit Protection

For ESD diode clamping protection, when the current flowing through ESD diode exceeds the maximum rating value, the ESD diode and amplifier will be damaged, so current-limit protection will be added in some applications. One resistor is selected to limit the current not to exceed the maximum rating value. In Figure 2, a series input resistor is used to limit the input current to less than 10mA, but the drawback of this current-limit resistor is that it contributes thermal noise at the amplifier input. If this resistor must be added, its value must be selected as small as possible.

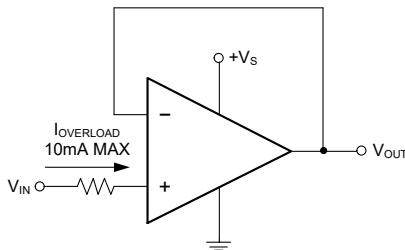

Figure 2. Input Current-Limit Protection

Rail-to-Rail Output

The SGM8968-1/2/4 support rail-to-rail output operation. In single power supply application, for example, when $+V_S = 5.5V$, $-V_S = GND$, 10kΩ load resistor is tied from OUT pin to $V_S/2$, the typical output swing range is from 0.008V to 5.492V.

Driving Capacitive Loads

The SGM8968-1/2/4 are designed for unity-gain stable for capacitive load up to 1nF. If greater capacitive load must be driven in application, the circuit in Figure 3 can be used. In this circuit, the IR drop voltage generated by R_{ISO} is compensated by feedback loop.

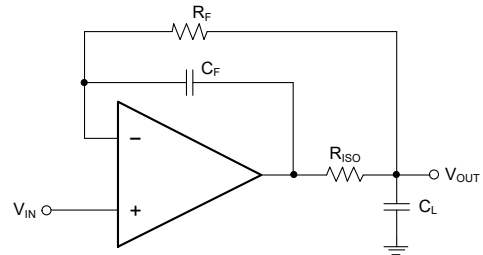

Figure 3. Circuit to Drive Heavy Capacitive Load

Power Supply Decoupling and Layout

A clean and low noise power supply is very important in amplifier circuit design, besides of input signal noise, the power supply is one of important source of noise to the amplifiers through $+V_S$ and $-V_S$ pins. Power supply bypassing is an effective method to clear up the noise at power supply, and the low impedance path to ground of decoupling capacitor will bypass the noise to GND. In application, 10μF ceramic capacitor paralleled with 0.1μF or 0.01μF ceramic capacitor is used in Figure 4. The ceramic capacitors should be placed as close as possible to $+V_S$ and $-V_S$ power supply pins.

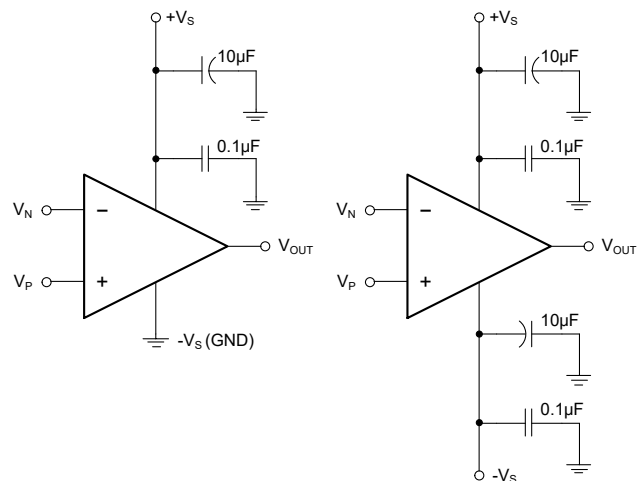

Figure 4. Amplifier Power Supply Bypassing

APPLICATION INFORMATION (continued)

Grounding

In low speed application, one node grounding technique is the simplest and most effective method to eliminate the noise generated by grounding. In high speed application, the general method to eliminate noise is to use a complete ground plane technique, and the whole ground plane will help distribute heat and reduce EMI noise pickup.

Reduce Input-to-Output Coupling

To reduce the input-to-output coupling, the input traces must be placed as far away from the power supply or output traces as possible. The sensitive trace must not be placed in parallel with the noisy trace in same layer. They must be placed perpendicularly in different layers to reduce the crosstalk. These PCB layout techniques will help to reduce unwanted positive feedback and noise.

Typical Application Circuits

Difference Amplifier

The circuit in Figure 5 is a design example of classical difference amplifier. If $R_4/R_3 = R_2/R_1$, then $V_{OUT} = (V_P - V_N) \times R_2/R_1 + V_{REF}$.

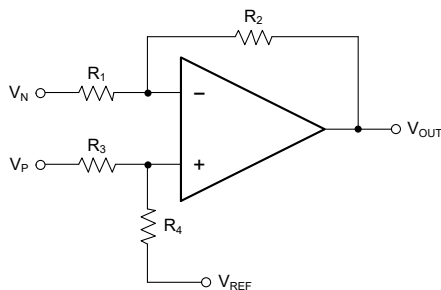

Figure 5. Difference Amplifier

High Input Impedance Difference Amplifier

The circuit in Figure 6 is a design example of high input impedance difference amplifier, the added amplifiers at the input are used to increase the input impedance and eliminate drawback of low input impedance in Figure 5.

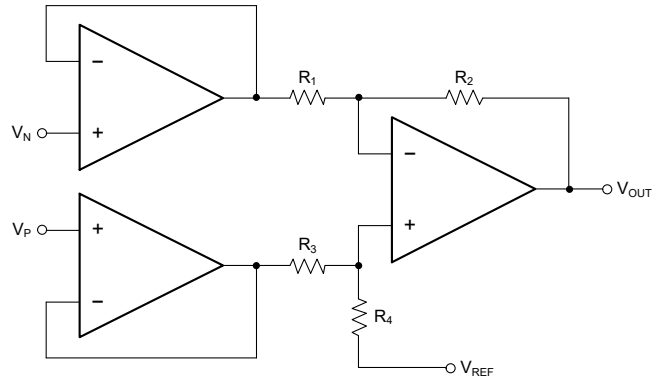

Figure 6. High Input Impedance Difference Amplifier

Active Low-Pass Filter

The circuit in Figure 7 is a design example of active low-pass filter, the DC gain is equal to $-R_2/R_1$ and the -3dB corner frequency is equal to $1/2\pi R_2 C$. In this design, the filter bandwidth must be less than the bandwidth of the amplifier, the resistor values must be selected as low as possible to reduce ringing or oscillation generated by the parasitic parameters in PCB layout.

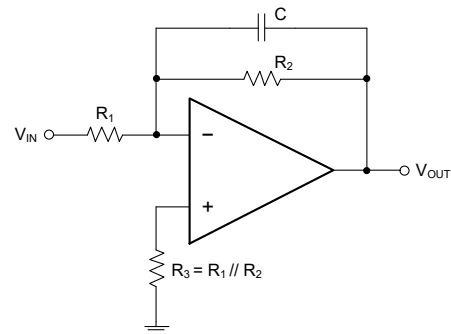

Figure 7. Active Low-Pass Filter

REVISION HISTORY

NOTE: Page numbers for previous revisions may differ from page numbers in the current version.

MAY 2020 – REV.A to REV.A.1	Page
Updated Electrical Characteristics section	4
Updated Typical Performance Characteristics section	8

Changes from Original (DECEMBER 2019) to REV.A	Page
Changed from product preview to production data.....	All

PACKAGE OUTLINE DIMENSIONS

SOT-23-5

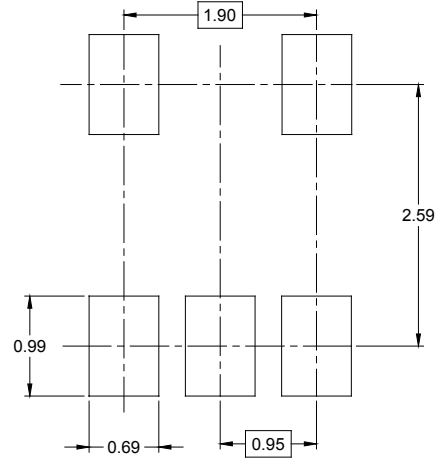
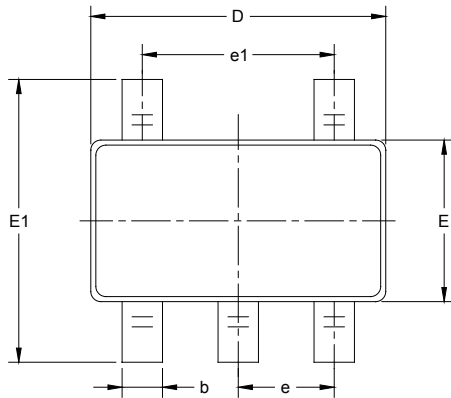

RECOMMENDED LAND PATTERN (Unit: mm)

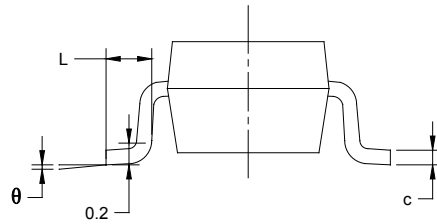
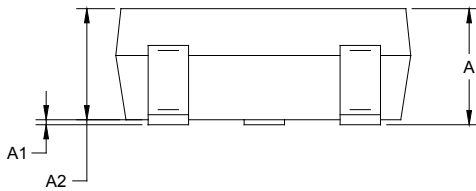

Symbol	Dimensions In Millimeters		Dimensions In Inches	
	MIN	MAX	MIN	MAX
A	1.050	1.250	0.041	0.049
A1	0.000	0.100	0.000	0.004
A2	1.050	1.150	0.041	0.045
b	0.300	0.500	0.012	0.020
c	0.100	0.200	0.004	0.008
D	2.820	3.020	0.111	0.119
E	1.500	1.700	0.059	0.067
E1	2.650	2.950	0.104	0.116
e	0.950 BSC		0.037 BSC	
e1	1.900 BSC		0.075 BSC	
L	0.300	0.600	0.012	0.024
θ	0°	8°	0°	8°

PACKAGE OUTLINE DIMENSIONS

SOIC-8

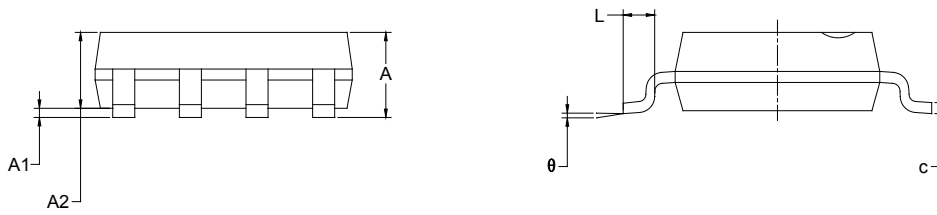
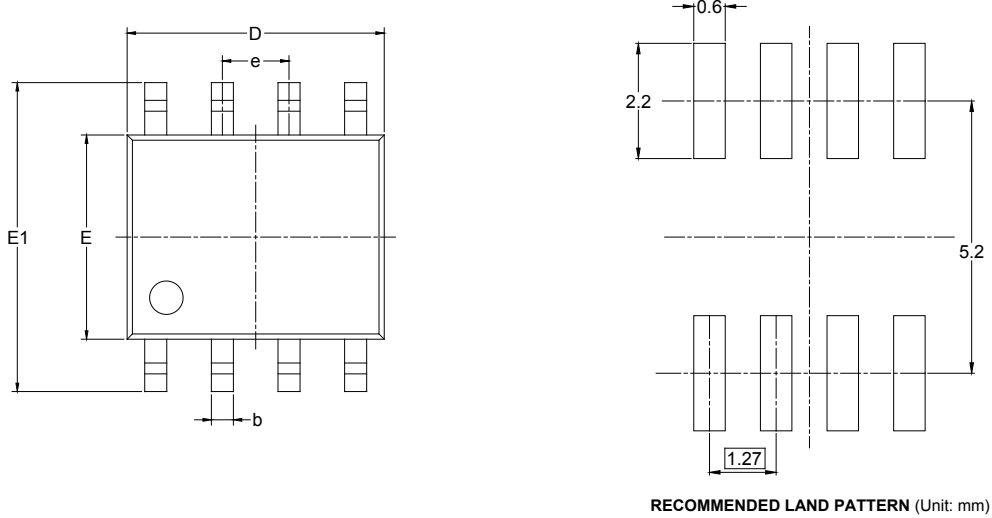

Symbol	Dimensions In Millimeters		Dimensions In Inches	
	MIN	MAX	MIN	MAX
A	1.350	1.750	0.053	0.069
A1	0.100	0.250	0.004	0.010
A2	1.350	1.550	0.053	0.061
b	0.330	0.510	0.013	0.020
c	0.170	0.250	0.006	0.010
D	4.700	5.100	0.185	0.200
E	3.800	4.000	0.150	0.157
E1	5.800	6.200	0.228	0.244
e	1.27 BSC		0.050 BSC	
L	0.400	1.270	0.016	0.050
θ	0°	8°	0°	8°

PACKAGE OUTLINE DIMENSIONS

MSOP-8

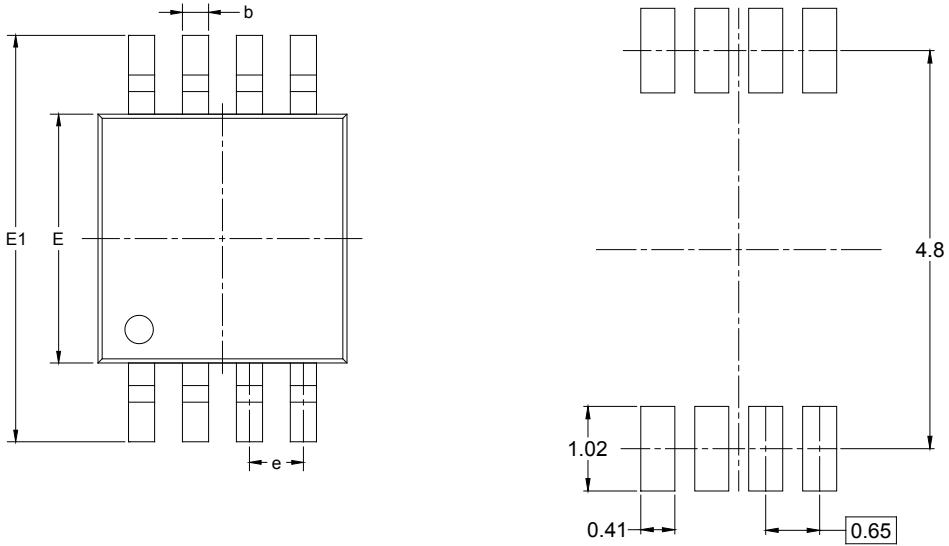

RECOMMENDED LAND PATTERN (Unit: mm)

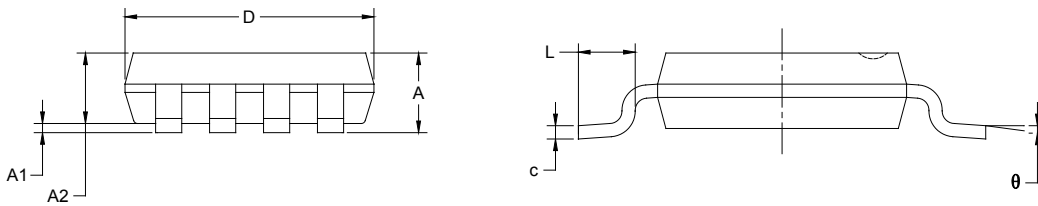

Symbol	Dimensions In Millimeters		Dimensions In Inches	
	MIN	MAX	MIN	MAX
A	0.820	1.100	0.032	0.043
A1	0.020	0.150	0.001	0.006
A2	0.750	0.950	0.030	0.037
b	0.250	0.380	0.010	0.015
c	0.090	0.230	0.004	0.009
D	2.900	3.100	0.114	0.122
E	2.900	3.100	0.114	0.122
E1	4.750	5.050	0.187	0.199
e	0.650 BSC		0.026 BSC	
L	0.400	0.800	0.016	0.031
θ	0°	6°	0°	6°

PACKAGE OUTLINE DIMENSIONS

SOIC-14

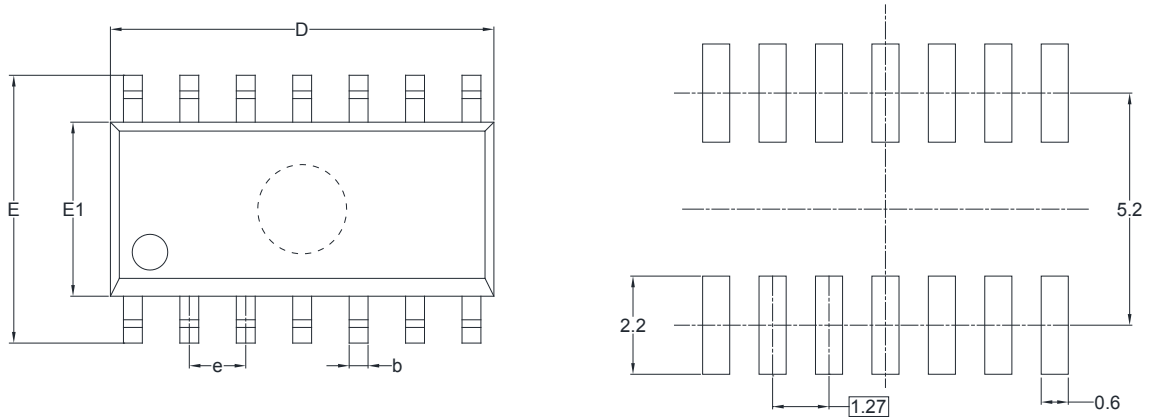

RECOMMENDED LAND PATTERN (Unit: mm)

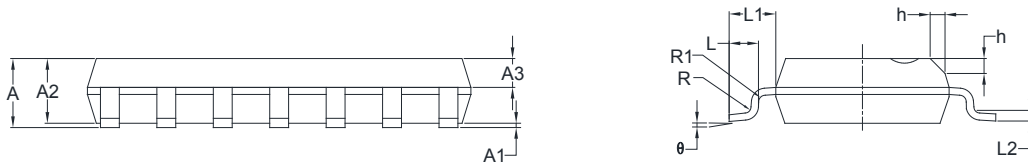

Symbol	Dimensions In Millimeters		Dimensions In Inches	
	MIN	MAX	MIN	MAX
A	1.35	1.75	0.053	0.069
A1	0.10	0.25	0.004	0.010
A2	1.25	1.65	0.049	0.065
A3	0.55	0.75	0.022	0.030
b	0.36	0.49	0.014	0.019
D	8.53	8.73	0.336	0.344
E	5.80	6.20	0.228	0.244
E1	3.80	4.00	0.150	0.157
e	1.27 BSC		0.050 BSC	
L	0.45	0.80	0.018	0.032
L1	1.04 REF		0.040 REF	
L2	0.25 BSC		0.01 BSC	
R	0.07		0.003	
R1	0.07		0.003	
h	0.30	0.50	0.012	0.020
θ	0°	8°	0°	8°

PACKAGE OUTLINE DIMENSIONS

TSSOP-14

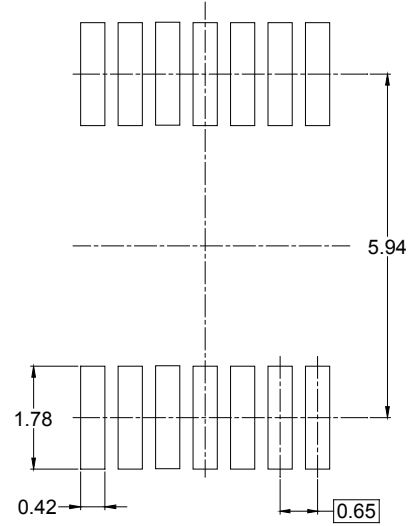
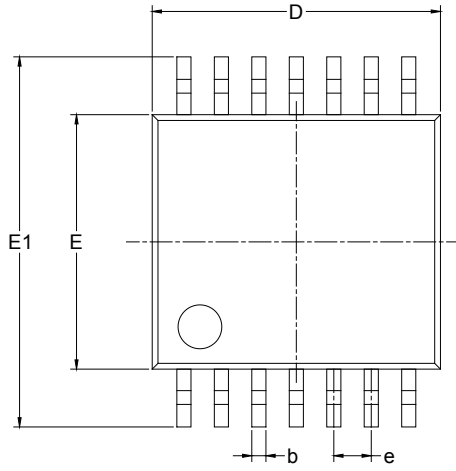

RECOMMENDED LAND PATTERN (Unit: mm)

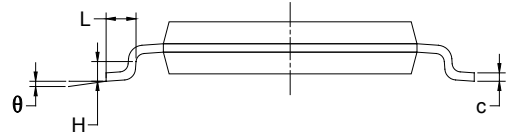
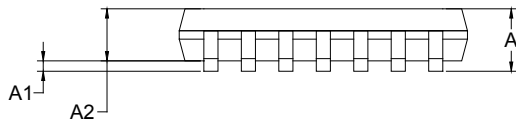

Symbol	Dimensions In Millimeters		Dimensions In Inches	
	MIN	MAX	MIN	MAX
A		1.200		0.047
A1	0.050	0.150	0.002	0.006
A2	0.800	1.050	0.031	0.041
b	0.190	0.300	0.007	0.012
c	0.090	0.200	0.004	0.008
D	4.860	5.100	0.191	0.201
E	4.300	4.500	0.169	0.177
E1	6.250	6.550	0.246	0.258
e	0.650 BSC		0.026 BSC	
L	0.500	0.700	0.02	0.028
H	0.25 TYP		0.01 TYP	
θ	1°	7°	1°	7°

PACKAGE INFORMATION

TAPE AND REEL INFORMATION

REEL DIMENSIONS



TAPE DIMENSIONS



NOTE: The picture is only for reference. Please make the object as the standard.

KEY PARAMETER LIST OF TAPE AND REEL

Package Type	Reel Diameter	Reel Width W1 (mm)	A0 (mm)	B0 (mm)	K0 (mm)	P0 (mm)	P1 (mm)	P2 (mm)	W (mm)	Pin1 Quadrant
SOT-23-5	7"	9.5	3.20	3.20	1.40	4.0	4.0	2.0	8.0	Q3
SOIC-8	13"	12.4	6.40	5.40	2.10	4.0	8.0	2.0	12.0	Q1
MSOP-8	13"	12.4	5.20	3.30	1.50	4.0	8.0	2.0	12.0	Q1
SOIC-14	13"	16.4	6.60	9.30	2.10	4.0	8.0	2.0	16.0	Q1
TSSOP-14	13"	12.4	6.95	5.60	1.20	4.0	8.0	2.0	12.0	Q1

D20001

PACKAGE INFORMATION

CARTON BOX DIMENSIONS



NOTE: The picture is only for reference. Please make the object as the standard.

KEY PARAMETER LIST OF CARTON BOX

Reel Type	Length (mm)	Width (mm)	Height (mm)	Pizza/Carton
7" (Option)	368	227	224	8
7"	442	410	224	18
13"	386	280	370	5

DD0002