

GENERAL DESCRIPTION

The SGM2240xQ is a low dropout positive voltage regulator. It is capable of supplying 1A output current with typical dropout voltage of 1.25V. The operating input voltage range is from 2.7V to 20V. The fixed output voltage range is from 1.5V to 12V and adjustable output voltage range is from 1.25V to 18V.

Other features include current limit and thermal shutdown protection. The SGM2240xQ is suitable for various automotive applications.

This device is AEC-Q100 qualified (Automotive Electronics Council (AEC) standard Q100 Grade 1) and it is suitable for automotive applications.

The SGM2240xQ is available in Green SOT-223-3 and TO-252-2A packages. It operates over an operating temperature range of -40°C to +125°C.

FEATURES

- **AEC-Q100 Qualified for Automotive Applications**
Device Temperature Grade 1
 $T_A = -40^{\circ}\text{C}$ to $+125^{\circ}\text{C}$
- **Operating Input Voltage Range: 2.7V to 20V**
- **Fixed Output from 1.5V to 12V**
- **Adjustable Output from 1.25V to 18V**
- **1A Output Current**
- **Output Voltage Accuracy: $\pm 1\%$ at $+25^{\circ}\text{C}$**
- **Low Dropout Voltage: 1.25V (TYP) at 1A**
- **Can Start Up when the Output Voltage is Negative**
- **Current Limiting and Thermal Protection**
- **Stable with Small Case Size Ceramic Capacitors**
- **-40°C to $+125^{\circ}\text{C}$ Operating Temperature Range**
- **Available in Green SOT-223-3 and TO-252-2A Packages**

APPLICATIONS

Automotive Applications
Consumer and Industrial Equipment Regulation

TYPICAL APPLICATION

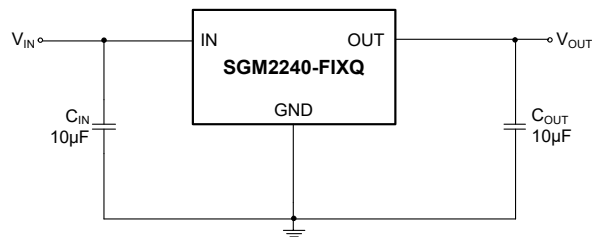

Fixed Voltage Typical Application Circuit

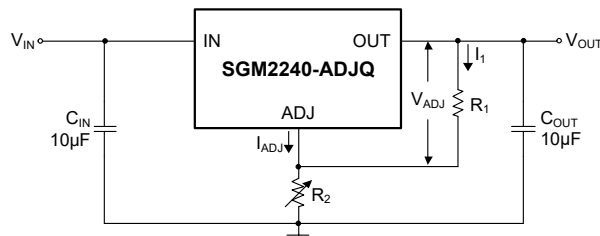

$$V_{OUT} = V_{ADJ} \times (1 + R_2/R_1) + I_{ADJ} \times R_2, I_1 = V_{ADJ}/R_1$$

If I_{ADJ} is far less than I_1 , $V_{OUT} = V_{ADJ} \times (1 + R_2/R_1)$.
Where V_{OUT} is output voltage and $V_{ADJ} = 1.25\text{V}$.

Adjustable Voltage Typical Application Circuit

Figure 1. Typical Application Circuits

Automotive, 1A, Low Dropout Positive Fixed and Adjustable Voltage Regulator

SGM2240xQ

PACKAGE/ORDERING INFORMATION

MODEL	PACKAGE DESCRIPTION	SPECIFIED TEMPERATURE RANGE	ORDERING NUMBER	PACKAGE MARKING	PACKING OPTION
SGM2240-1.5Q	SOT-223-3	-40°C to +125°C (T _A)	SGM2240-1.5QKC3G/TR	14G XXXXX	Tape and Reel, 2500
SGM2240-1.8Q	SOT-223-3	-40°C to +125°C (T _A)	SGM2240-1.8QKC3G/TR	14H XXXXX	Tape and Reel, 2500
SGM2240-2.5Q	SOT-223-3	-40°C to +125°C (T _A)	SGM2240-2.5QKC3G/TR	14I XXXXX	Tape and Reel, 2500
SGM2240-2.8Q	SOT-223-3	-40°C to +125°C (T _A)	SGM2240-2.8QKC3G/TR	14J XXXXX	Tape and Reel, 2500
SGM2240-2.85Q	SOT-223-3	-40°C to +125°C (T _A)	SGM2240-2.85QKC3G/TR	14K XXXXX	Tape and Reel, 2500
SGM2240-3.0Q	SOT-223-3	-40°C to +125°C (T _A)	SGM2240-3.0QKC3G/TR	14L XXXXX	Tape and Reel, 2500
SGM2240-3.3Q	SOT-223-3	-40°C to +125°C (T _A)	SGM2240-3.3QKC3G/TR	0RK XXXXX	Tape and Reel, 2500
SGM2240-5.0Q	SOT-223-3	-40°C to +125°C (T _A)	SGM2240-5.0QKC3G/TR	0RL XXXXX	Tape and Reel, 2500
SGM2240-12Q	SOT-223-3	-40°C to +125°C (T _A)	SGM2240-12QKC3G/TR	14M XXXXX	Tape and Reel, 2500
SGM2240-ADJQ	SOT-223-3	-40°C to +125°C (T _A)	SGM2240-ADJQKC3G/TR	0RJ XXXXX	Tape and Reel, 2500
SGM2240-1.5Q	TO-252-2A	-40°C to +125°C (T _A)	SGM2240-1.5QOC2G/TR	14OOC2 XXXXX	Tape and Reel, 2500
SGM2240-1.8Q	TO-252-2A	-40°C to +125°C (T _A)	SGM2240-1.8QOC2G/TR	14POC2 XXXXX	Tape and Reel, 2500
SGM2240-2.5Q	TO-252-2A	-40°C to +125°C (T _A)	SGM2240-2.5QOC2G/TR	14QOC2 XXXXX	Tape and Reel, 2500
SGM2240-2.8Q	TO-252-2A	-40°C to +125°C (T _A)	SGM2240-2.8QOC2G/TR	14ROC2 XXXXX	Tape and Reel, 2500
SGM2240-2.85Q	TO-252-2A	-40°C to +125°C (T _A)	SGM2240-2.85QOC2G/TR	14SOC2 XXXXX	Tape and Reel, 2500
SGM2240-3.0Q	TO-252-2A	-40°C to +125°C (T _A)	SGM2240-3.0QOC2G/TR	14TOC2 XXXXX	Tape and Reel, 2500
SGM2240-3.3Q	TO-252-2A	-40°C to +125°C (T _A)	SGM2240-3.3QOC2G/TR	0RMOC2 XXXXX	Tape and Reel, 2500
SGM2240-5.0Q	TO-252-2A	-40°C to +125°C (T _A)	SGM2240-5.0QOC2G/TR	0RNOC2 XXXXX	Tape and Reel, 2500
SGM2240-12Q	TO-252-2A	-40°C to +125°C (T _A)	SGM2240-12QOC2G/TR	14UOC2 XXXXX	Tape and Reel, 2500
SGM2240-ADJQ	TO-252-2A	-40°C to +125°C (T _A)	SGM2240-ADJQOC2G/TR	0ULOC2 XXXXX	Tape and Reel, 2500

MARKING INFORMATION

NOTE: XXXXX = Date Code, Trace Code and Vendor Code.

SOT-223-3/TO-252-2A

XXXXX

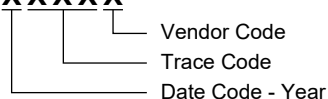

Green (RoHS & HSF): SG Micro Corp defines "Green" to mean Pb-Free (RoHS compatible) and free of halogen substances. If you have additional comments or questions, please contact your SGMICRO representative directly.

ABSOLUTE MAXIMUM RATINGS

Input to Output Voltage	24V
Package Thermal Resistance	
SOT-223-3, θ_{JA}	67°C/W
SOT-223-3, θ_{JB}	21°C/W
SOT-223-3, $\theta_{JC(TOP)}$	50°C/W
SOT-223-3, $\theta_{JC(BOT)}$	21°C/W
TO-252-2A, θ_{JA}	39°C/W
TO-252-2A, θ_{JB}	14°C/W
TO-252-2A, $\theta_{JC(TOP)}$	48°C/W
TO-252-2A, $\theta_{JC(BOT)}$	12°C/W
Junction Temperature	+150°C
Storage Temperature Range	-65°C to +150°C
Lead Temperature (Soldering, 10s)	+260°C
ESD Susceptibility ^{(1) (2)}	
HBM	±3000V
CDM	±1000V

NOTES:

1. For human body model (HBM), all pins comply with AEC-Q100-002 specification.
2. For charged device model (CDM), all pins comply with AEC-Q100-011 specification.

RECOMMENDED OPERATING CONDITIONS

Input Voltage Range	2.7V to 20V
Input Effective Capacitance, C_{IN}	2.2 μ F (MIN)
Output Effective Capacitance, C_{OUT}	2.2 μ F to 200 μ F
Capacitor Equivalent Series Resistance, ESR... 1m Ω to 2.2 Ω	
Operating Ambient Temperature Range	-40°C to +125°C
Operating Junction Temperature Range	-40°C to +150°C

OVERSTRESS CAUTION

Stresses beyond those listed in Absolute Maximum Ratings may cause permanent damage to the device. Exposure to absolute maximum rating conditions for extended periods may affect reliability. Functional operation of the device at any conditions beyond those indicated in the Recommended Operating Conditions section is not implied.

ESD SENSITIVITY CAUTION

This integrated circuit can be damaged if ESD protections are not considered carefully. SGMICRO recommends that all integrated circuits be handled with appropriate precautions. Failure to observe proper handling and installation procedures can cause damage. ESD damage can range from subtle performance degradation to complete device failure. Precision integrated circuits may be more susceptible to damage because even small parametric changes could cause the device not to meet the published specifications.

DISCLAIMER

SG Micro Corp reserves the right to make any change in circuit design, or specifications without prior notice.

PIN CONFIGURATIONS

SGM2240xQ (TOP VIEW)

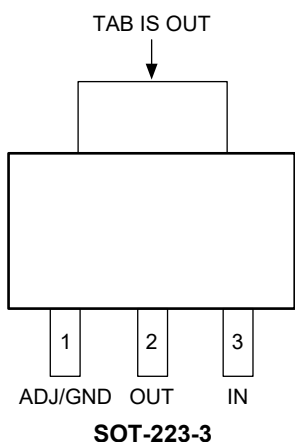

SGM2240xQ (TOP VIEW)

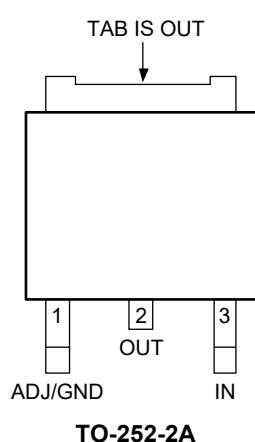

PIN DESCRIPTION

PIN		NAME	FUNCTION
SOT-223-3	TO-252-2A		
1	1	ADJ	Feedback Voltage Input Pin (adjustable output voltage version only). Connect this pin to the midpoint of an external resistor divider to adjust the output voltage. Place the resistors as close as possible to this pin.
		GND	Ground (fixed output voltage version only).
2, TAB	2, TAB	OUT	Regulator Output Pin. It is recommended to use a ceramic capacitor with effective capacitance in the range of 2.2 μ F to 200 μ F to ensure stability. This ceramic capacitor should be placed as close as possible to OUT pin.
3	3	IN	Input Supply Voltage Pin. It is recommended to use a 4.7 μ F or larger ceramic capacitor from IN pin to ground to get good power supply decoupling. This ceramic capacitor should be placed as close as possible to IN pin.

FUNCTIONAL BLOCK DIAGRAMS

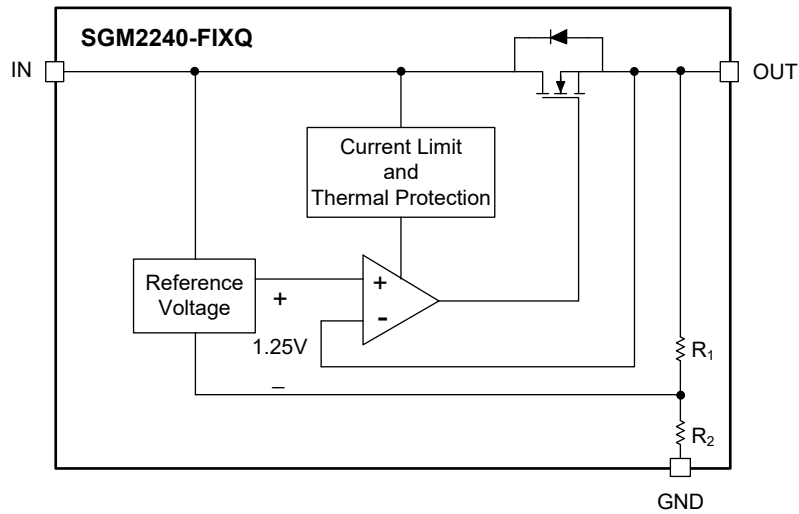

Figure 2. Internal Block Diagram of Fixed Output Voltage

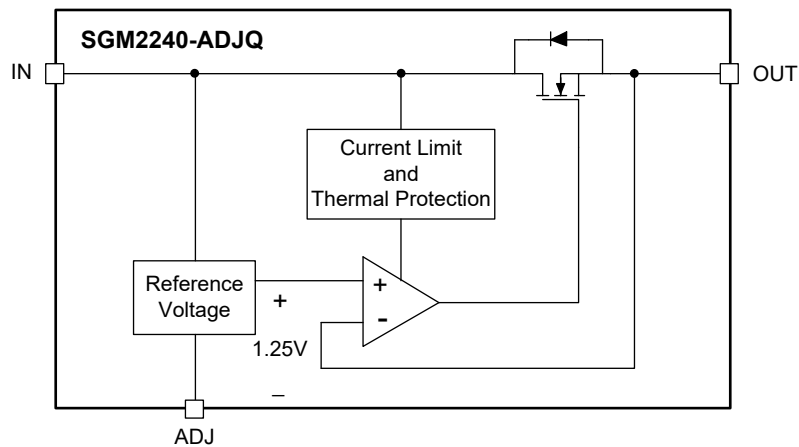

Figure 3. Internal Block Diagram of Adjustable Output Voltage

Automotive, 1A, Low Dropout Positive Fixed and Adjustable Voltage Regulator

ELECTRICAL CHARACTERISTICS

($C_{IN} = 10\mu\text{F}$, $C_{OUT} = 10\mu\text{F}$, $T_J = -40^\circ\text{C}$ to $+125^\circ\text{C}$ ⁽¹⁾, typical values are at $T_J = +25^\circ\text{C}$, unless otherwise noted.)

PARAMETER	SYMBOL	CONDITIONS	MIN	TYP	MAX	UNITS
Input Voltage Range	V_{IN}		2.7		20	V
Output Voltage Accuracy (SGM2240-FIXQ)	V_{OUT}	$(V_{IN} - V_{OUT}) = 1.4\text{V}$, $I_{OUT} = 0\text{mA}$, $T_J = +25^\circ\text{C}$	-1		+1	%
		$(V_{IN} - V_{OUT}) = 1.4\text{V}$, $I_{OUT} = 0\text{mA}$ to 1A	-2		+2	
		$V_{IN} = (V_{OUT} + 1.4\text{V})$ to 20V , $I_{OUT} = 0\text{mA}$	-2		+2	
Reference Voltage (SGM2240-ADJQ)	V_{ADJ}	$(V_{IN} - V_{OUT}) = 1.4\text{V}$, $I_{OUT} = 5\text{mA}$, $T_J = +25^\circ\text{C}$	1.238	1.25	1.262	V
		$(V_{IN} - V_{OUT}) = 1.4\text{V}$, $I_{OUT} = 5\text{mA}$ to 1A	1.225		1.275	
		$V_{IN} = (V_{OUT} + 1.4\text{V})$ to 20V , $I_{OUT} = 5\text{mA}$	1.225		1.275	
ADJ Pin Current ⁽²⁾	I_{ADJ}	$V_{IN} = 20\text{V}$, $I_{OUT} = 5\text{mA}$, SGM2240-ADJQ		22	35	μA
ADJ Pin Current Change	ΔI_{ADJ}	$(V_{IN} - V_{OUT}) = 1.4\text{V}$, $I_{OUT} = 5\text{mA}$ to 1A , SGM2240-ADJQ		0.3	1	μA
		$V_{IN} = (V_{OUT} + 1.4\text{V})$ to 20V , $I_{OUT} = 5\text{mA}$, SGM2240-ADJQ		0.3	1	
Line Regulation	$\Delta V_{OUT}/V_{OUT}$	$V_{IN} = (V_{OUT} + 1.4\text{V})$ to 20V , $I_{OUT} = 5\text{mA}$, SGM2240-ADJQ		0.01	0.3	%
		$V_{IN} = (V_{OUT} + 1.4\text{V})$ to 20V , $I_{OUT} = 0\text{mA}$, SGM2240-FIXQ		0.01	0.3	
Load Regulation	$\Delta V_{OUT}/V_{OUT}$	$(V_{IN} - V_{OUT}) = 1.4\text{V}$, $I_{OUT} = 5\text{mA}$ to 1A , SGM2240-ADJQ		0.01	0.4	%
		$(V_{IN} - V_{OUT}) = 1.4\text{V}$, $I_{OUT} = 0\text{mA}$ to 1A , SGM2240-FIXQ		0.01	0.4	
Dropout Voltage ⁽³⁾	V_{DROP}	$I_{OUT} = 100\text{mA}$		1.05	1.20	V
		$I_{OUT} = 500\text{mA}$		1.15	1.30	
		$I_{OUT} = 800\text{mA}$		1.21	1.37	
		$I_{OUT} = 1\text{A}$		1.25	1.40	
Output Current Limit	I_{LIMIT}	$(V_{IN} - V_{OUT}) = 5\text{V}$, $\Delta V_{OUT} = 5\%$	1.0	1.45		A
		$(V_{IN} - V_{OUT}) = 20\text{V}$, $V_{OUT} = 0\text{V}$	0.2	0.45		
Minimum Load Current ⁽⁴⁾	I_{OUT_MIN}	$V_{IN} = 20\text{V}$, SGM2240-ADJQ		2	5	mA
Supply Pin Current	I_Q	$V_{IN} = 20\text{V}$, $I_{OUT} = 0\text{mA}$, SGM2240-FIXQ		2.2	5	mA
Start-Up Time	t_{STR}	From assertion of V_{IN} to $V_{OUT} = 95\% \times V_{OUT(NOM)}$		0.45	1.2	ms
Temperature Stability	S_T			0.4		%
Power Supply Ripple Rejection	PSRR	$\Delta V_{RIPPLE} = 3V_{P-P}$, $(V_{IN} - V_{OUT}) = 3\text{V}$, $I_{OUT} = 500\text{mA}$, $f_{RIPPLE} = 120\text{Hz}$, $C_{OUT} = 10\mu\text{F}$	SGM2240-ADJQ	76		dB
			$V_{OUT(NOM)} = 3.3\text{V}$	67		
			$V_{OUT(NOM)} = 5.0\text{V}$	64		
			$V_{OUT(NOM)} = 12\text{V}$	56		
Output Voltage Noise	e_n	$f = 10\text{Hz}$ to 10kHz , $I_{OUT} = 1\text{A}$		0.0035		%
Thermal Regulation		30ms Pulse, $T_J = +25^\circ\text{C}$		0.002	0.02	%/W
Long Term Stability	S_t	1000Hrs End Point Measurement, $T_J = +125^\circ\text{C}$		0.1		%
Thermal Shutdown Temperature	T_{SHDN}			180		$^\circ\text{C}$
Thermal Shutdown Hysteresis	ΔT_{SHDN}			25		$^\circ\text{C}$

NOTES:

1. Tested under pulse load conditions, so $T_J \approx T_A$.
2. See Figure 1, $V_{OUT} = V_{ADJ} \times (1 + R_2/R_1) + I_{ADJ} \times R_2$, $I_1 = V_{ADJ}/R_1$. To minimize the voltage error introduced by I_{ADJ} , choose an appropriate value for R_1 .
3. The dropout voltage is defined as the difference between V_{IN} and V_{OUT} when V_{OUT} falls to $(V_{OUT(NOM)} - 100\text{mV})$.
4. The minimum output current required to maintain regulation.

TYPICAL PERFORMANCE CHARACTERISTICS

$T_J = +25^{\circ}\text{C}$, $(V_{IN} - V_{OUT}) = 3\text{V}$, $C_{IN} = 10\mu\text{F}$, $C_{OUT} = 10\mu\text{F}$ (ceramic capacitor), unless otherwise noted.

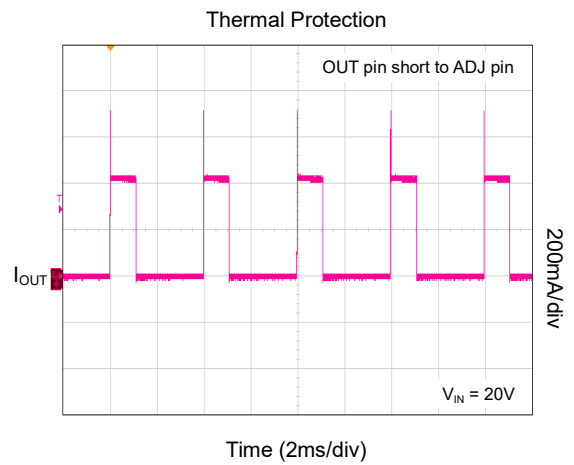
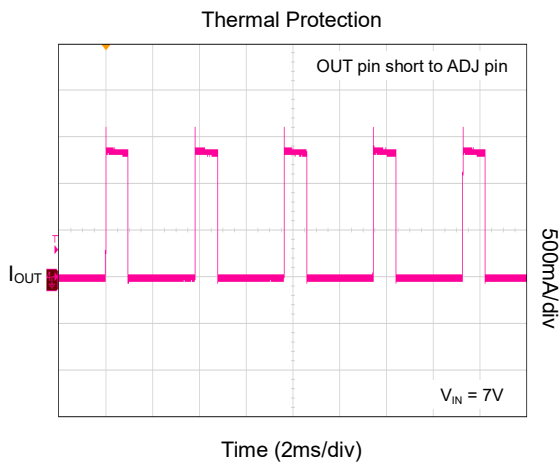
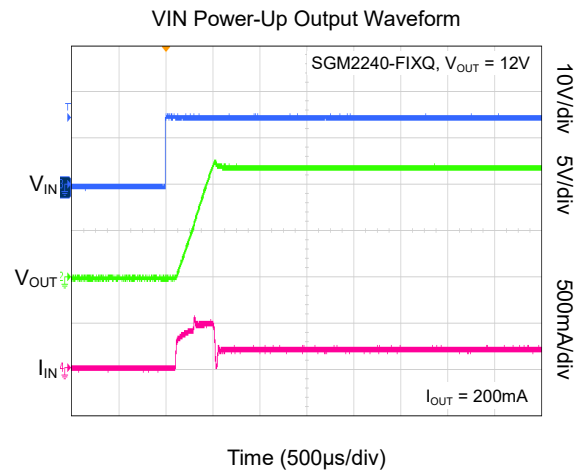
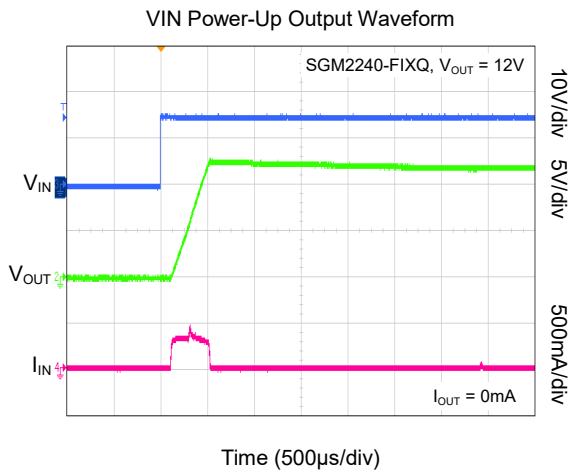
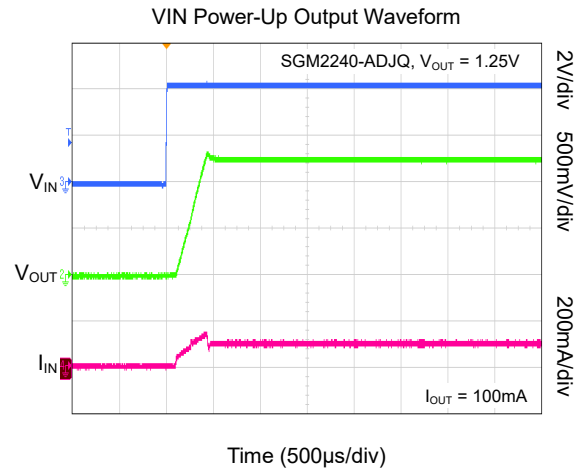
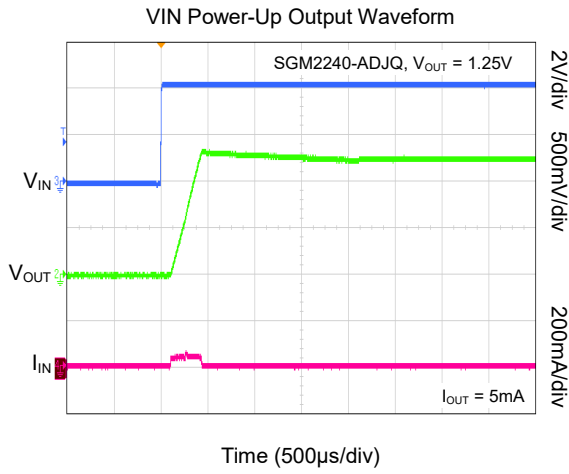

TYPICAL PERFORMANCE CHARACTERISTICS (continued)

T_J = +25°C, (V_{IN} - V_{OUT}) = 3V, C_{IN} = 10μF, C_{OUT} = 10μF (ceramic capacitor), unless otherwise noted.

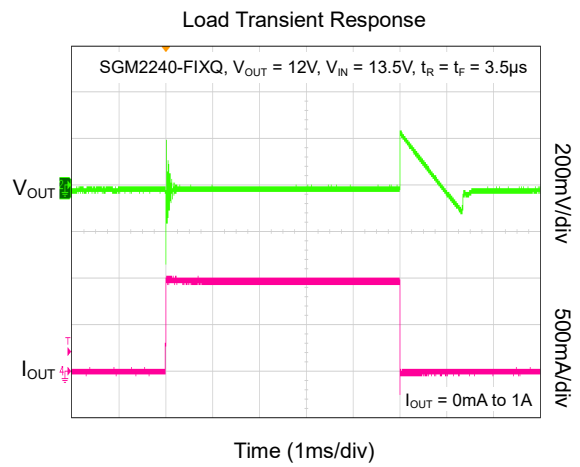
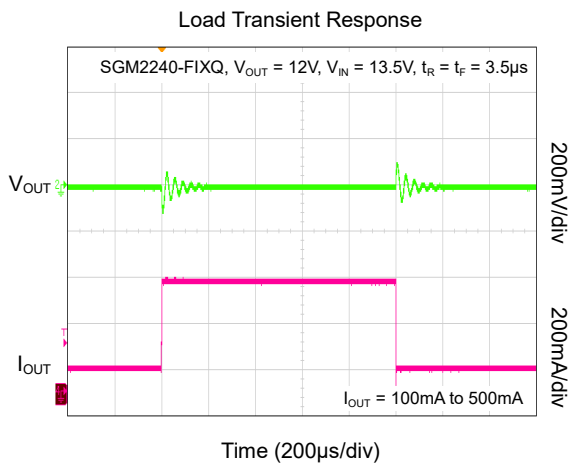
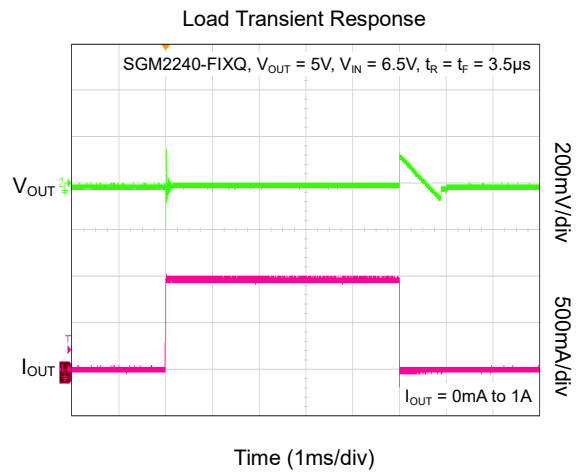
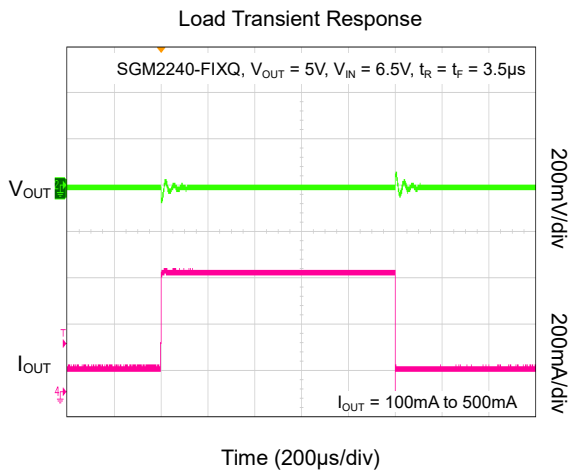
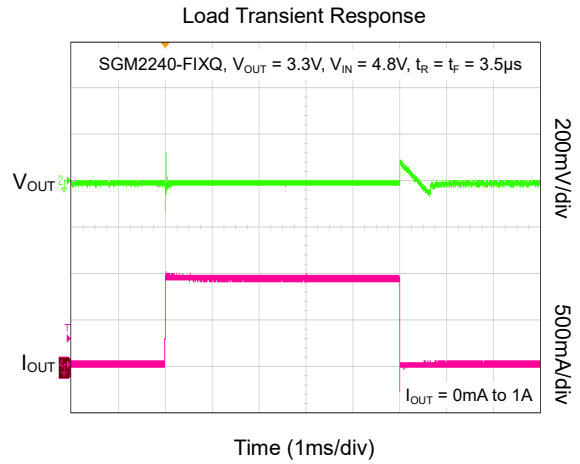
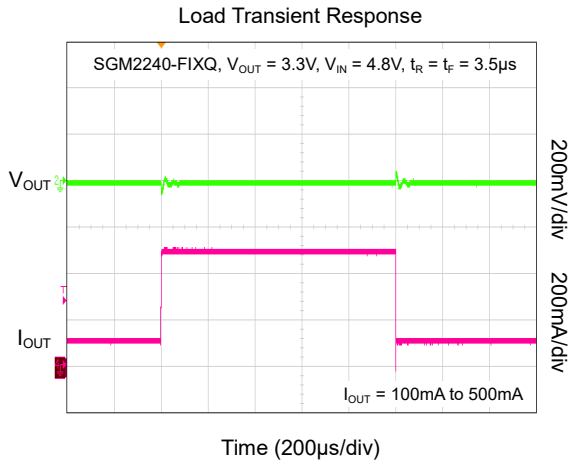

TYPICAL PERFORMANCE CHARACTERISTICS (continued)

$T_J = +25^\circ\text{C}$, $(V_{IN} - V_{OUT}) = 3\text{V}$, $C_{IN} = 10\mu\text{F}$, $C_{OUT} = 10\mu\text{F}$ (ceramic capacitor), unless otherwise noted.

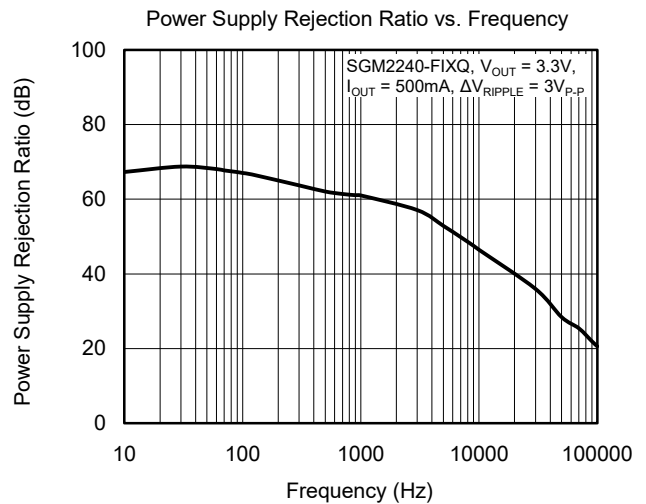
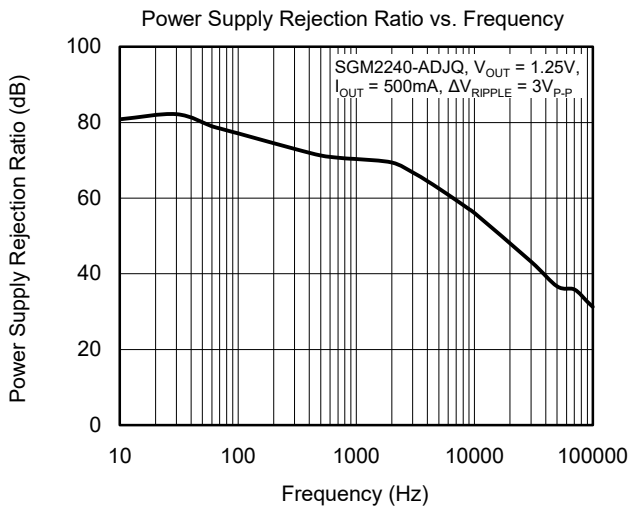
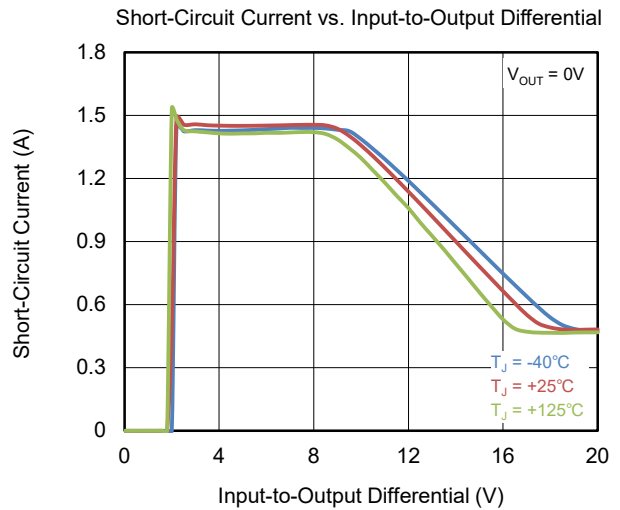
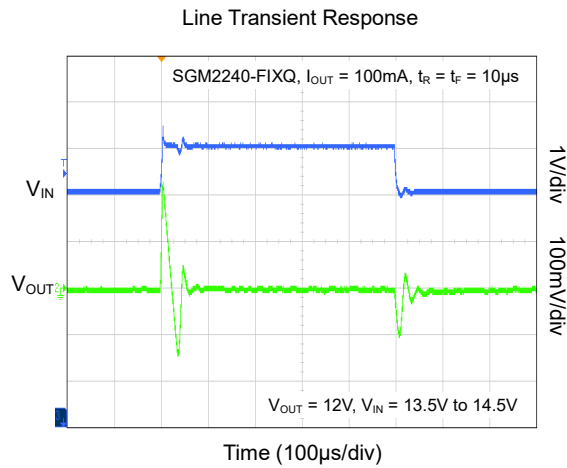
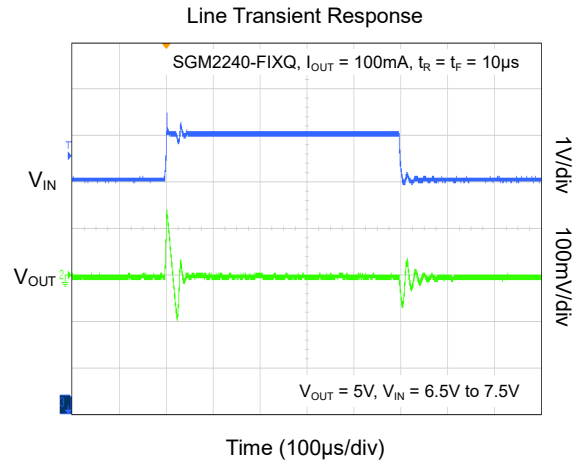
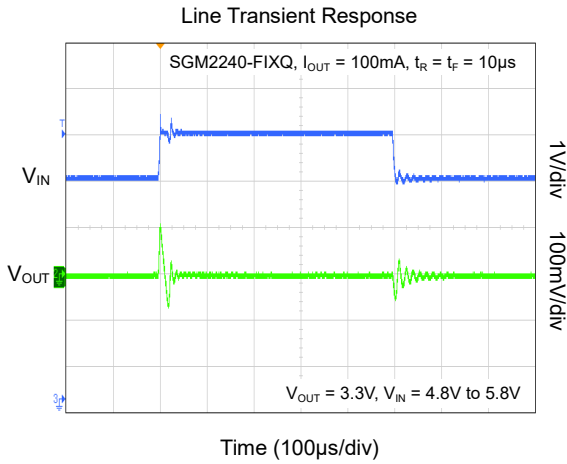

Automotive, 1A, Low Dropout Positive Fixed and Adjustable Voltage Regulator

SGM2240xQ

TYPICAL PERFORMANCE CHARACTERISTICS (continued)

$T_J = +25^\circ\text{C}$, $(V_{IN} - V_{OUT}) = 3\text{V}$, $C_{IN} = 10\mu\text{F}$, $C_{OUT} = 10\mu\text{F}$ (ceramic capacitor), unless otherwise noted.

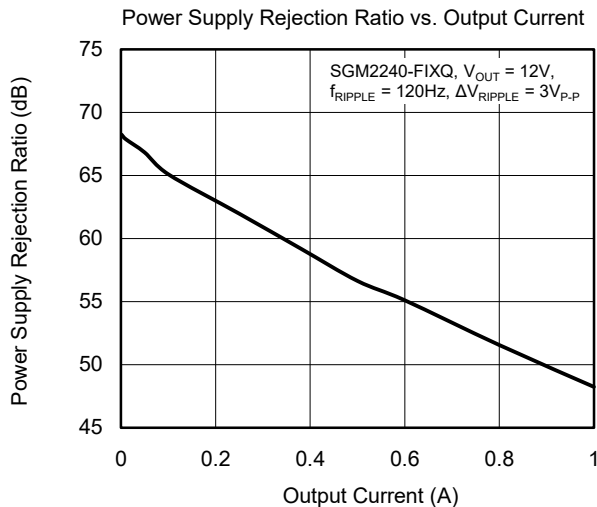
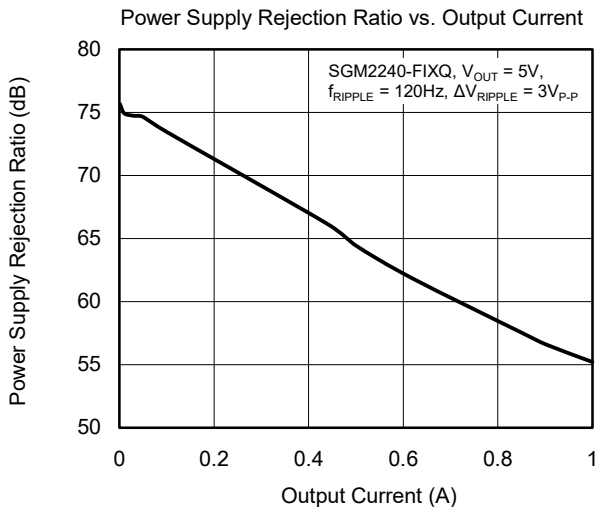
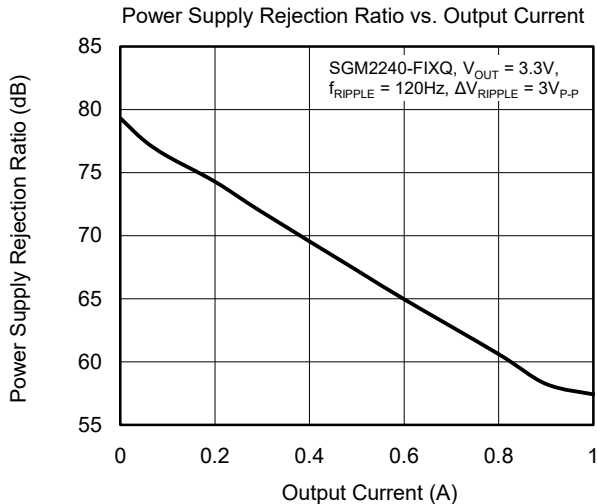
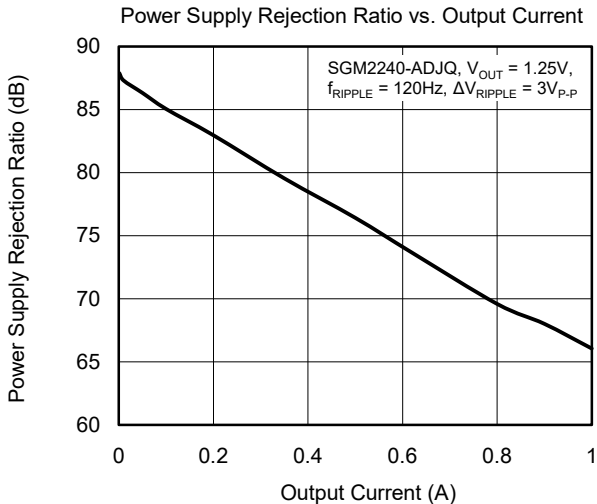
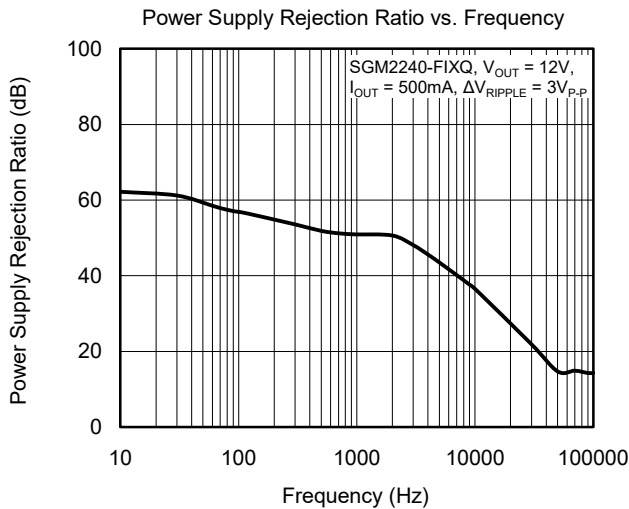
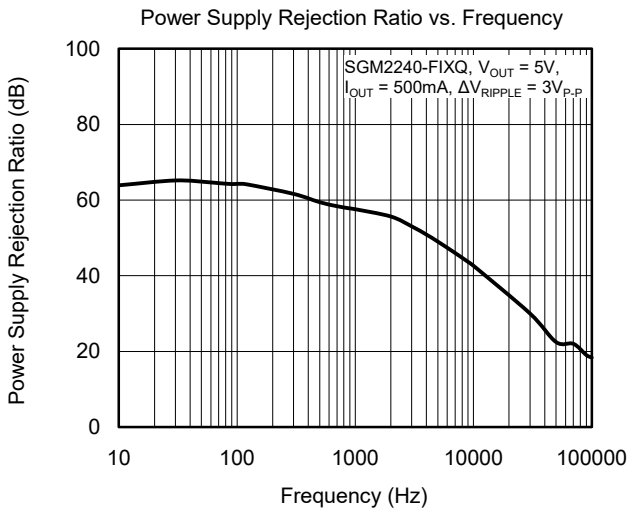

TYPICAL PERFORMANCE CHARACTERISTICS (continued)

$T_J = +25^\circ\text{C}$, $(V_{IN} - V_{OUT}) = 3\text{V}$, $C_{IN} = 10\mu\text{F}$, $C_{OUT} = 10\mu\text{F}$ (ceramic capacitor), unless otherwise noted.

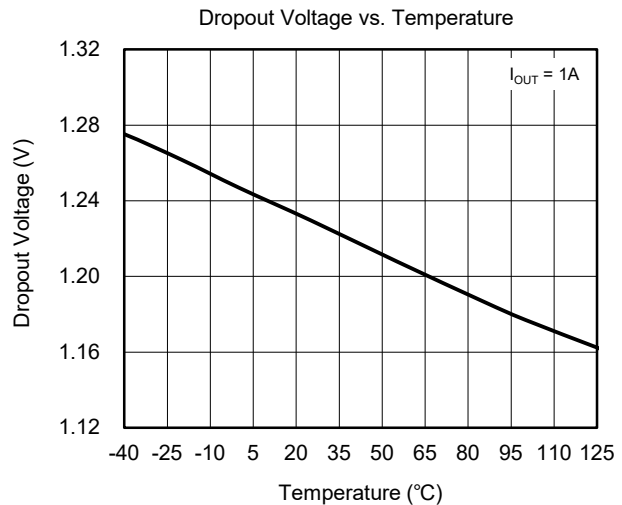
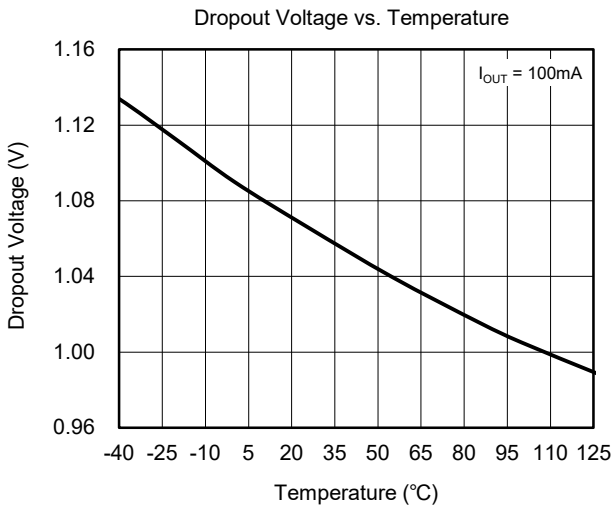
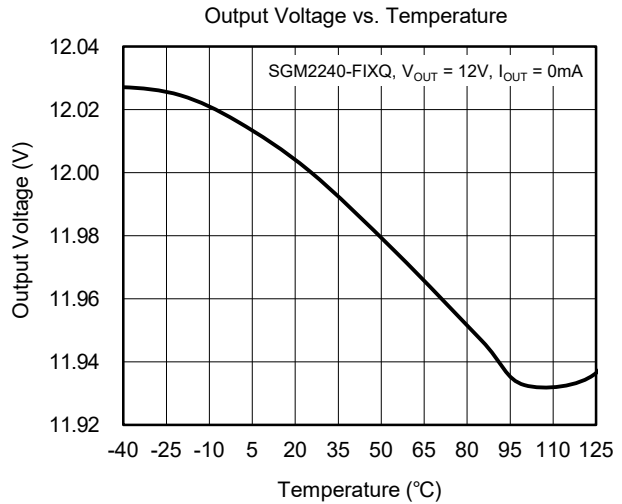
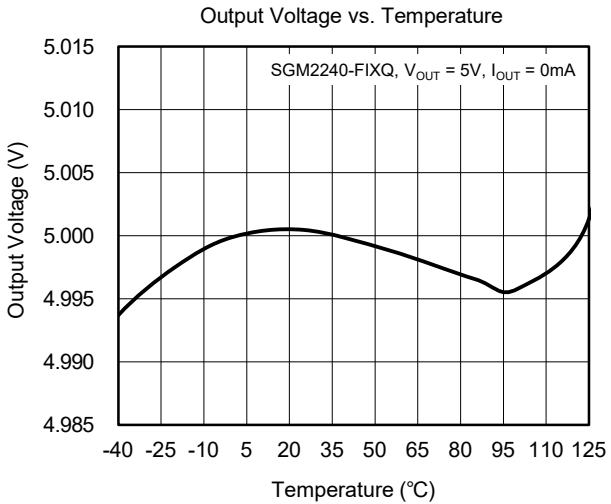
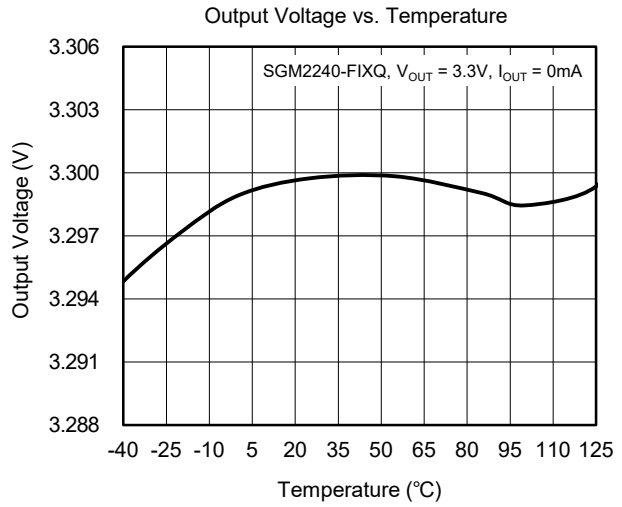
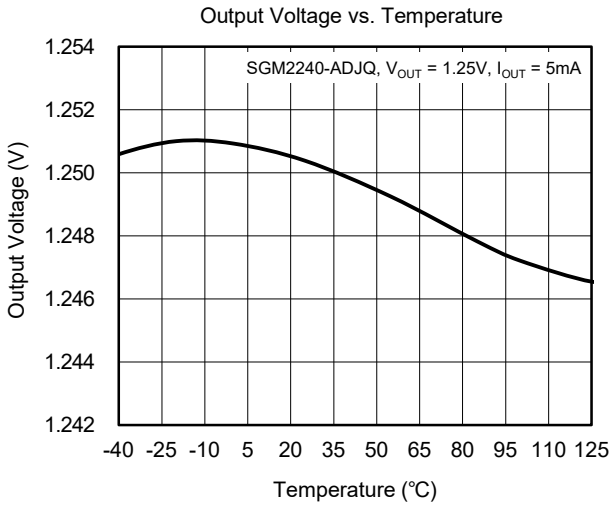

SGM2240xQ Automotive, 1A, Low Dropout Positive Fixed and Adjustable Voltage Regulator

TYPICAL PERFORMANCE CHARACTERISTICS (continued)

$T_J = +25^\circ\text{C}$, $(V_{IN} - V_{OUT}) = 3\text{V}$, $C_{IN} = 10\mu\text{F}$, $C_{OUT} = 10\mu\text{F}$ (ceramic capacitor), unless otherwise noted.

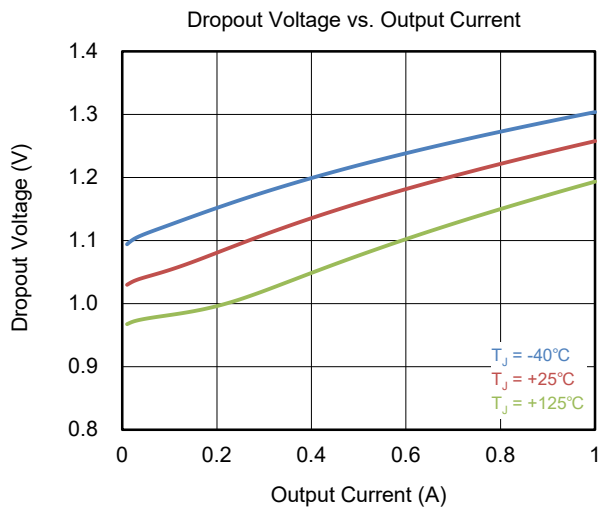
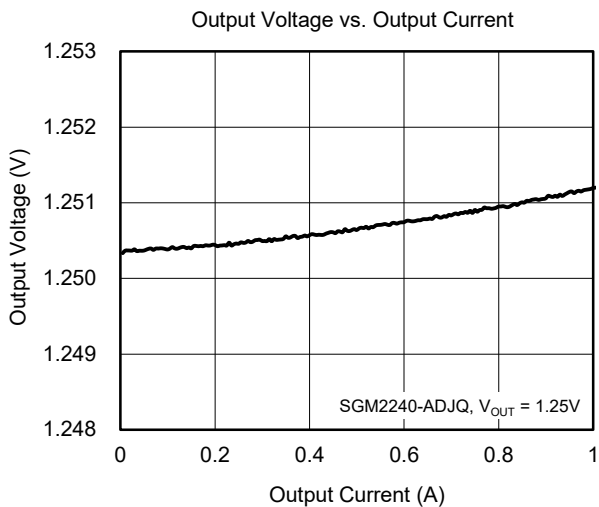
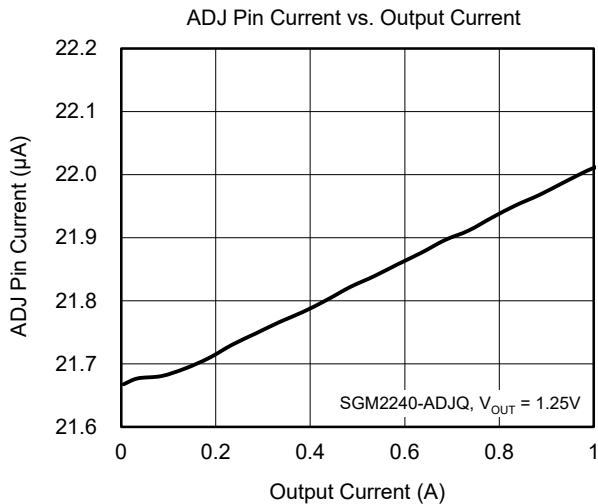
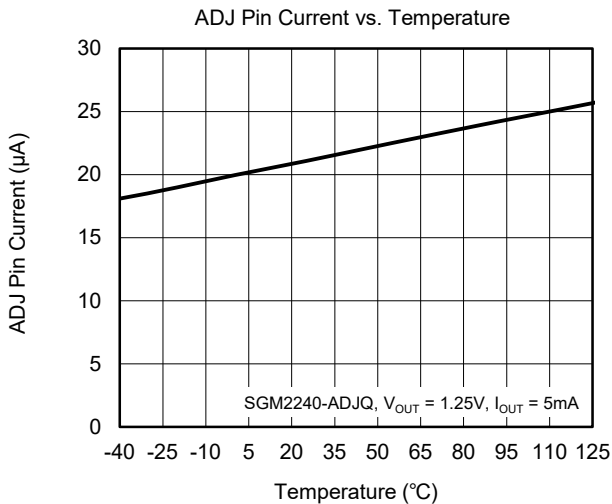
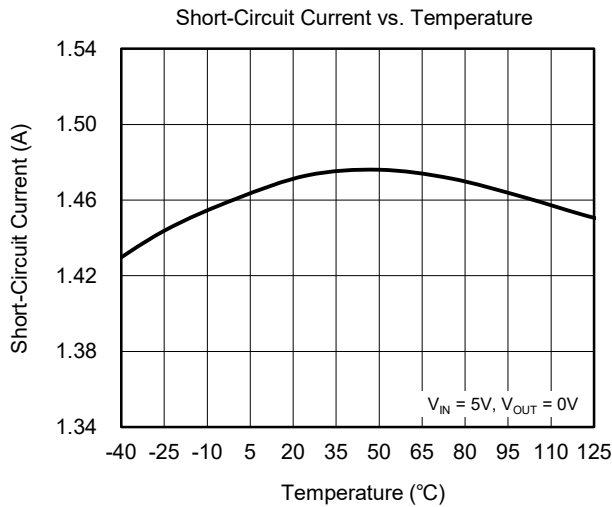
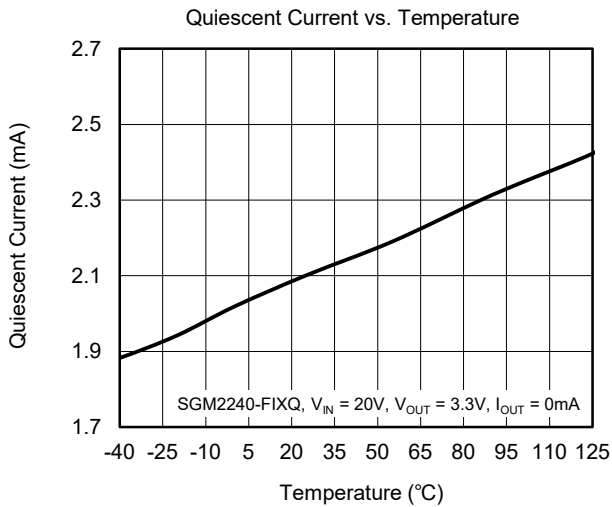

TYPICAL PERFORMANCE CHARACTERISTICS (continued)

$T_J = +25^\circ\text{C}$, $(V_{IN} - V_{OUT}) = 3\text{V}$, $C_{IN} = 10\mu\text{F}$, $C_{OUT} = 10\mu\text{F}$ (ceramic capacitor), unless otherwise noted.

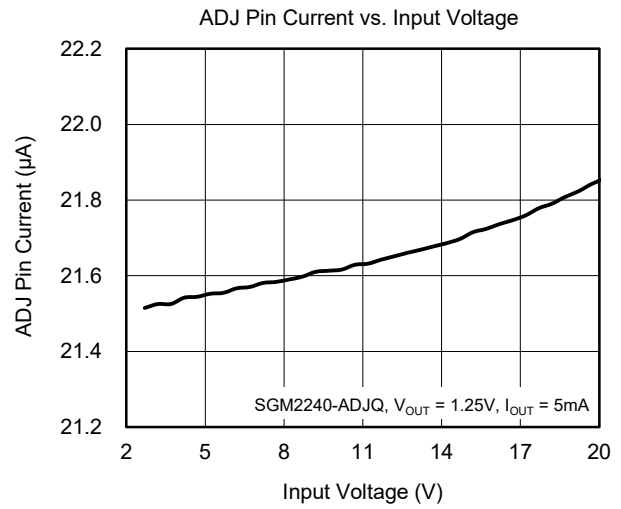
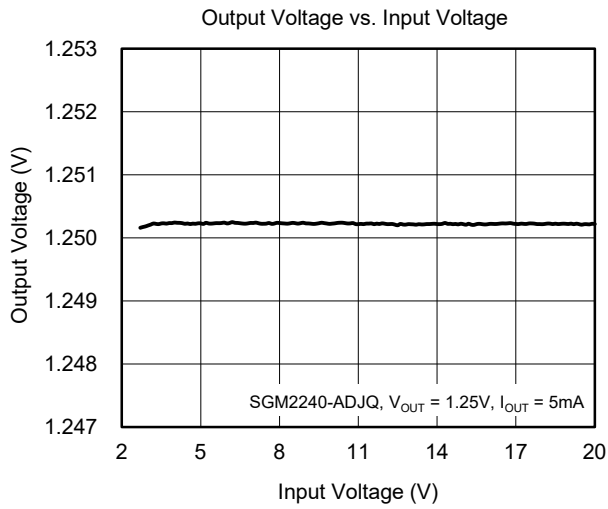

APPLICATION INFORMATION

The SGM2240xQ is a low noise, high current and low dropout LDO and provides 1A output current. These features make the device a reliable solution to solve many challenging problems in the generation of clean and accurate power supply. The high performance also makes the SGM2240xQ useful in a variety of applications. The SGM2240xQ provides protection functions for output overload, output short-circuit condition and overheating.

Input Capacitor Selection (C_{IN})

The input decoupling capacitor should be placed as close as possible to the IN pin for ensuring the device stability. 4.7µF or larger X7R or X5R ceramic capacitor is selected to get good dynamic performance.

When V_{IN} is required to provide large current instantaneously, a large effective input capacitor is required. Multiple input capacitors can limit the input tracking inductance. Adding more input capacitors is available to restrict the ringing and to keep it below the device absolute maximum ratings. For C_{OUT} with larger capacitance, it is recommended to choose the larger capacitance C_{IN}.

Output Capacitor Selection (C_{OUT})

One or more output capacitors are required to maintain the stability of the LDO, and the output capacitors should be placed as close as possible to the OUT pin. In addition, in order to obtain the best transient performance, it is recommended to use X7R and X5R ceramic capacitors as output capacitors. Ceramic capacitors have low equivalent series resistance (ESR), excellent temperature and DC bias characteristics. However, it cannot be ignored that the effective capacitance of ceramic capacitors is affected by temperature, DC bias and package size.

For example, Figure 4 shows the capacitance and DC bias and temperature characteristics of 0805, 10V, 10µF±10%, X7R capacitor. Therefore, it is necessary to evaluate whether the effective capacitance of the output capacitor can meet the stability requirements of the LDO in practical applications. In general, a capacitor in higher voltage rating and a larger package exhibits better stability, and the effective capacitance can be obtained from the manufacturer datasheet.

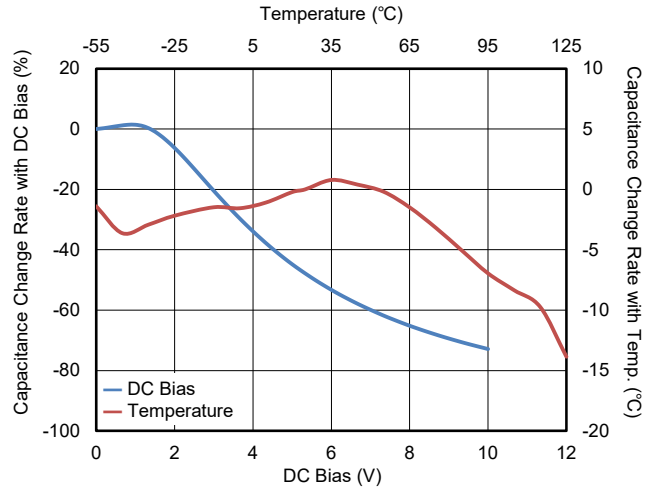

Figure 4. Capacitance vs. DC Bias and Temperature Characteristics

The SGM2240xQ requires an output capacitor with effective capacitance in the range of 2.2µF to 200µF with an ESR of 2.2Ω or less. Additionally, C_{OUT} with larger capacitance and lower ESR will help increase the high frequency PSRR and improve the load transient response.

Adjustable Regulator

The output voltage of the SGM2240-ADJQ can be adjusted from 1.25V to 18V. The ADJ pin will be connected to two external resistors as shown in Figure 5.

The PSRR and noise of adjustable LDO circuit can be modified slightly to levels close to that of the unity-gain LDO. The adjustment terminal can be bypassed to ground with a capacitor (C_{ADJ}). The impedance of the C_{ADJ} should be equal to or less than R₂ at the desired frequency.

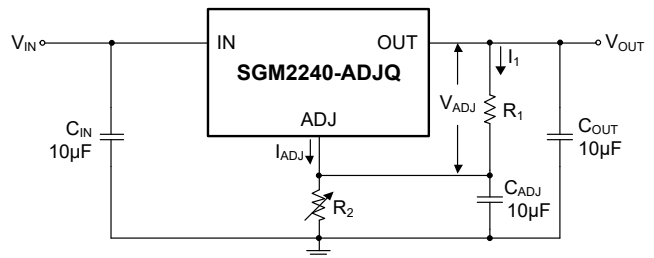

$V_{OUT} = V_{ADJ} \times (1 + R_2/R_1) + I_{ADJ} \times R_2, I_1 = V_{ADJ}/R_1$
 If I_{ADJ} is far less than I_1 , $V_{OUT} = V_{ADJ} \times (1 + R_2/R_1)$.
 Where V_{OUT} is output voltage and $V_{ADJ} = 1.25V$.

Figure 5. Adjustable Output Voltage Application

APPLICATION INFORMATION (continued)

Output Current Limit and Short-Circuit Protection

The current limiting circuit reduces the output current as the input-to-output differential increases after 2ms of power-on. The current limit is reduced from 1.45A to 0.45A when (V_{IN} - V_{OUT}) is greater than about 18V.

During normal start-up, the input-to-output differential is small since the output follows the input. But, if the output is shorted, then the recovery involves a large input-to-output differential. Sometimes during this condition the current limiting circuit is slow in recovering. If the limited current is too low to develop a voltage at the output, the voltage will stabilize at a lower level. Under these conditions it may be necessary to recycle the power of the regulator in order to get the smaller differential voltage and thus adequate start-up conditions.

Reverse Current Protection

The SGM2240-ADJQ doesn't incorporate reverse current protection circuit, must add protection diodes prevents current flow backwards through the pass element when the output voltage is greater than the input voltage.

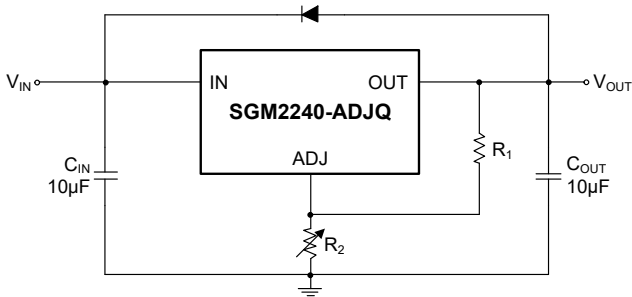

Figure 6. Reverse Protection Reference Design

Thermal Shutdown

When the die temperature exceeds the threshold value of thermal shutdown, the SGM2240xQ will be in shutdown state and it will remain in this state until the die temperature decreases to +155°C.

Power Dissipation (P_D)

Power dissipation (P_D) of the SGM2240xQ can be calculated by the equation P_D = (V_{IN} - V_{OUT}) × I_{OUT}. The maximum allowable power dissipation (P_{D(MAX)}) of the SGM2240xQ is affected by many factors, including the difference between junction temperature and ambient temperature (T_{J(MAX)} - T_A), package thermal resistance from the junction to the ambient environment (θ_{JA}), the rate of ambient airflow and PCB layout. P_{D(MAX)} can be approximated by the following equation:

$$P_{D(MAX)} = (T_{J(MAX)} - T_A) / \theta_{JA} \quad (1)$$

Layout Guidelines

To get good PSRR, low output noise and high transient response performance, the input and output bypass capacitors must be placed as close as possible to the IN pin and OUT pin separately.

REVISION HISTORY

NOTE: Page numbers for previous revisions may differ from page numbers in the current version.

APRIL 2026 – REV.A.3 to REV.A.4	Page
Updated Typical Performance Characteristics section	12
<hr/>	
MARCH 2026 – REV.A.2 to REV.A.3	Page
Updated Package Outline Dimensions.....	18
<hr/>	
FEBRUARY 2026 – REV.A.1 to REV.A.2	Page
Updated Typical Application section	1
Updated Functional Block Diagrams section.....	5
Updated Electrical Characteristics section	6
<hr/>	
JULY 2025 – REV.A to REV.A.1	Page
Updated Package Outline Dimensions.....	17
<hr/>	
Changes from Original (OCTOBER 2024) to REV.A	Page
Changed from product preview to production data.....	All
<hr/>	

PACKAGE INFORMATION

PACKAGE OUTLINE DIMENSIONS

SOT-223-3

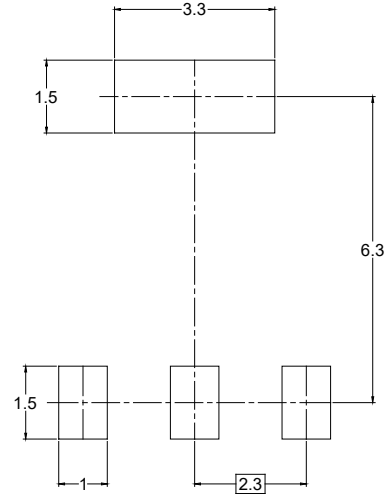
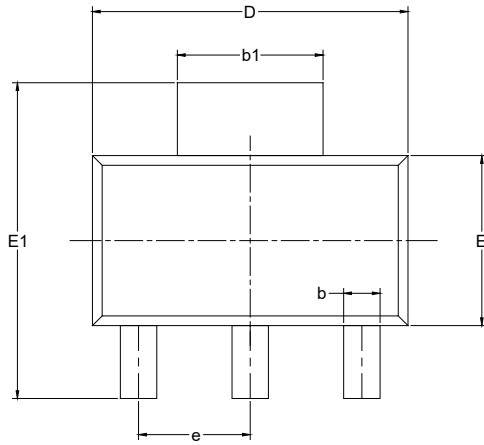

RECOMMENDED LAND PATTERN (Unit: mm)

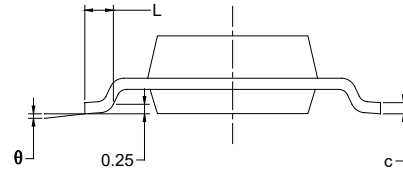
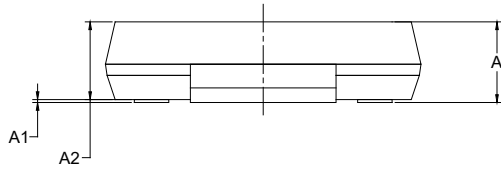

Symbol	Dimensions In Millimeters		Dimensions In Inches	
	MIN	MAX	MIN	MAX
A		1.800		0.071
A1	0.020	0.100	0.001	0.004
A2	1.500	1.700	0.059	0.067
b	0.660	0.840	0.026	0.033
b1	2.900	3.100	0.114	0.122
c	0.230	0.350	0.009	0.014
D	6.300	6.700	0.248	0.264
E	3.300	3.700	0.130	0.146
E1	6.700	7.300	0.264	0.287
e	2.300 BSC		0.091 BSC	
L	0.750		0.030	
θ	0°	10°	0°	10°

NOTES:

1. Body dimensions do not include mode flash or protrusion.
2. This drawing is subject to change without notice.

PACKAGE OUTLINE DIMENSIONS

TO-252-2A

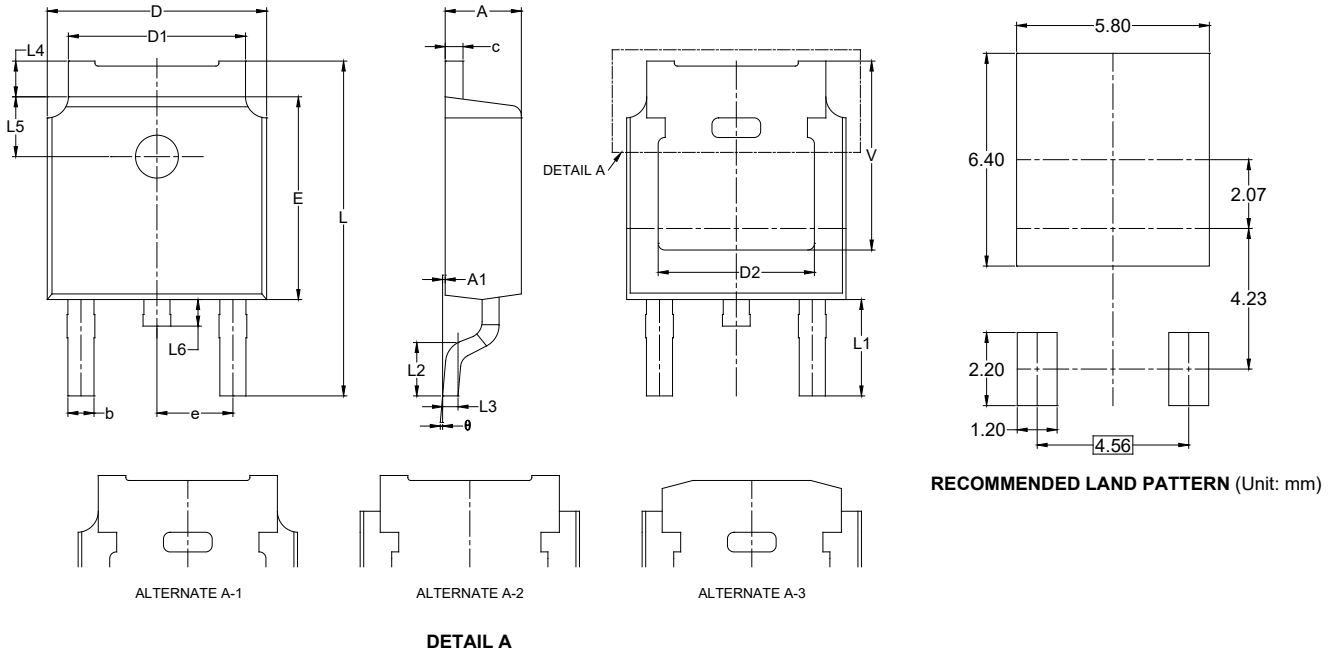

Symbol	Dimensions In Millimeters		
	MIN	NOM	MAX
A	2.184	-	2.388
A1	0.000	-	0.127
b	0.635	-	0.889
c	0.457	-	0.889
D	6.350	-	6.731
D1	4.953	-	5.461
D2	4.318	-	5.500
E	5.969	-	6.223
e	2.286 BSC		
L	9.398	-	10.414
L1	2.900 REF		
L2	1.397	-	1.778
L3	0.508 BSC		
L4	0.889	-	1.270
L5	1.800 REF		
L6	0.600	-	1.106
V	5.150	-	5.650
θ	0°	-	10°

NOTES:

1. This drawing is subject to change without notice.
2. The dimensions do not include mold flashes, protrusions or gate burrs.
3. Reference JEDEC TO-252.

PACKAGE INFORMATION

TAPE AND REEL INFORMATION

REEL DIMENSIONS

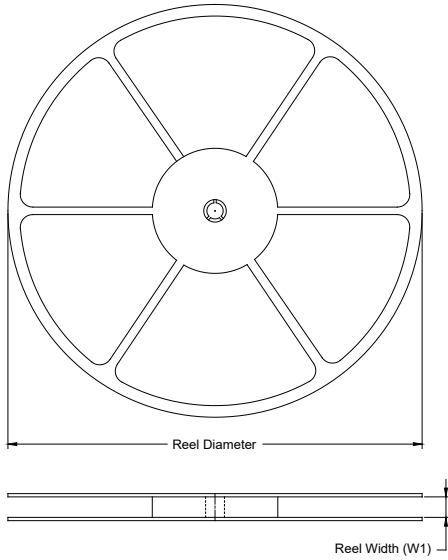

TAPE DIMENSIONS

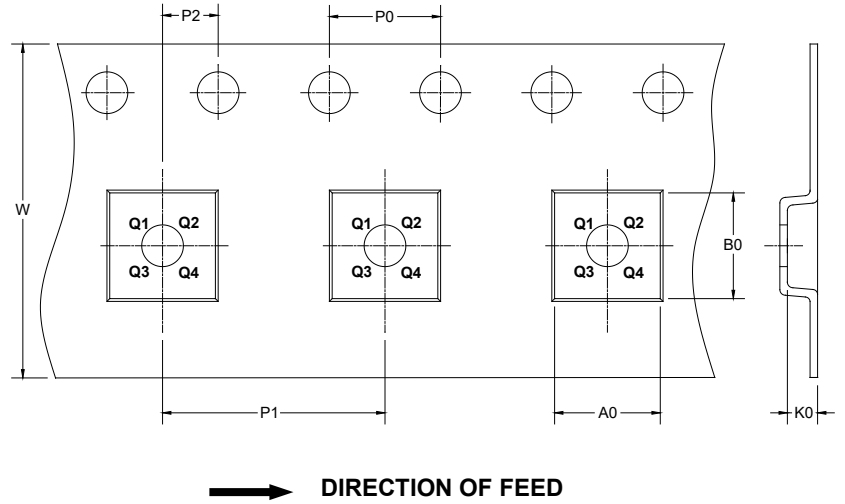

NOTE: The picture is only for reference. Please make the object as the standard.

KEY PARAMETER LIST OF TAPE AND REEL

Package Type	Reel Diameter	Reel Width W1 (mm)	A0 (mm)	B0 (mm)	K0 (mm)	P0 (mm)	P1 (mm)	P2 (mm)	W (mm)	Pin1 Quadrant
SOT-223-3	13"	12.4	6.55	7.25	1.90	4.0	8.0	2.0	12.0	Q3
TO-252-2A	13"	16.4	6.90	10.50	2.70	4.0	8.0	2.0	16.0	

DD0001

PACKAGE INFORMATION

CARTON BOX DIMENSIONS

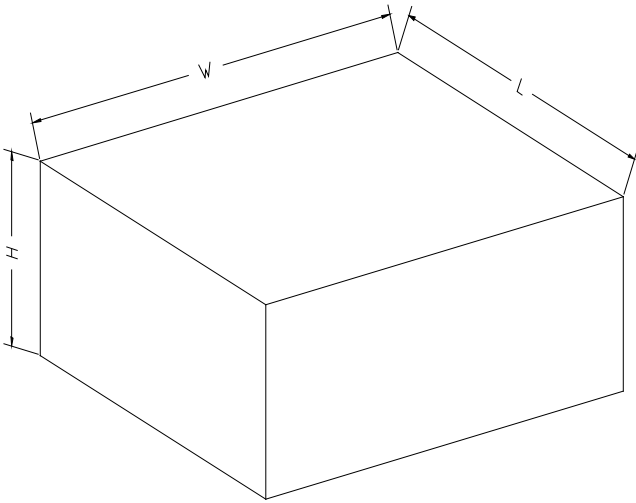

NOTE: The picture is only for reference. Please make the object as the standard.

KEY PARAMETER LIST OF CARTON BOX

Reel Type	Length (mm)	Width (mm)	Height (mm)	Pizza/Carton
13"	386	280	370	5

DD0002