

GENERAL DESCRIPTION

The SGM2061 is a low noise, high PSRR and low dropout voltage linear regulator. It is capable of supplying 450mA output current with typical dropout voltage of only 70mV. The operating input voltage range is from 1.9V to 5.5V. The fixed output voltages are 1.8V, 2.5V, 2.55V, 2.8V, 3.0V, 3.3V and 5.0V.

Other features include logic-controlled shutdown mode, short-circuit current limit and thermal shutdown protection. The SGM2061 has automatic discharge function to quickly discharge V_{OUT} in the disabled status.

The SGM2061 is suitable for applications which need low noise and fast transient response power supply, such as power supply of camera module in smart phone, etc.

The SGM2061 is available in an ultra-thin Green WLCSP-0.64×0.64-4B-A package. It operates over an operating temperature range of -40°C to +125°C.

FEATURES

- **Operating Input Voltage Range: 1.9V to 5.5V**
- **Enable Pin Accept Voltages Higher than the Supply Voltage and up to 5.5V**
- **Fixed Output from 1.8V to 5.0V**
- **450mA Output Current**
- **Output Voltage Accuracy: ±1% at +25°C**
- **Ultra-Low Quiescent Current: 15µA (TYP)**
- **Low Dropout Voltage:**
70mV (TYP) at 450mA, $V_{OUT} = 2.8V$
- **Ultra-Low Noise: 10µV_{RMS} (TYP)**
- **High PSRR: 92dB (TYP) at 1kHz**
- **Standby Current: 0.03µA (TYP)**
- **Current Limiting and Thermal Protection**
- **Excellent Load and Line Transient Responses**
- **With Output Automatic Discharge**
- **Stable with Small Case Size Ceramic Capacitors**
- **-40°C to +125°C Operating Temperature Range**
- **Available in an Ultra-Thin Green WLCSP-0.64×0.64-4B-A Package**

APPLICATIONS

- Portable Electronic Devices
- Smoke Detectors
- IP Cameras
- Wireless LAN Devices
- Battery-Powered Equipment
- Smartphones and Tablets
- Digital Cameras and Audio Devices

TYPICAL APPLICATION

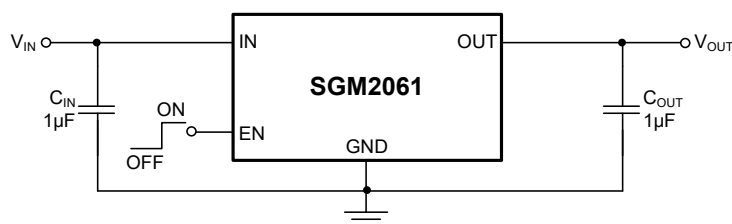

Figure 1. Typical Application Circuit

PACKAGE/ORDERING INFORMATION

MODEL	PACKAGE DESCRIPTION	SPECIFIED TEMPERATURE RANGE	ORDERING NUMBER	PACKAGE MARKING	PACKING OPTION
SGM2061-1.8	WLCSP-0.64×0.64-4B-A	-40°C to +125°C	SGM2061-1.8XG/TR	QF	Tape and Reel, 5000
SGM2061-2.5	WLCSP-0.64×0.64-4B-A	-40°C to +125°C	SGM2061-2.5XG/TR	R0	Tape and Reel, 5000
SGM2061-2.55	WLCSP-0.64×0.64-4B-A	-40°C to +125°C	SGM2061-2.55XG/TR	0V	Tape and Reel, 5000
SGM2061-2.8	WLCSP-0.64×0.64-4B-A	-40°C to +125°C	SGM2061-2.8XG/TR	R1	Tape and Reel, 5000
SGM2061-3.0	WLCSP-0.64×0.64-4B-A	-40°C to +125°C	SGM2061-3.0XG/TR	R2	Tape and Reel, 5000
SGM2061-3.3	WLCSP-0.64×0.64-4B-A	-40°C to +125°C	SGM2061-3.3XG/TR	R3	Tape and Reel, 5000
SGM2061-5.0	WLCSP-0.64×0.64-4B-A	-40°C to +125°C	SGM2061-5.0XG/TR	R4	Tape and Reel, 5000

MARKING INFORMATION

YY

Serial Number

Green (RoHS & HSF): SG Micro Corp defines "Green" to mean Pb-Free (RoHS compatible) and free of halogen substances. If you have additional comments or questions, please contact your SGMICRO representative directly.

ABSOLUTE MAXIMUM RATINGS

IN to GND	-0.3V to 6V
OUT to GND	-0.3V to ($V_{IN} + 0.3V$)
EN to GND	-0.3V to 6V
Package Thermal Resistance	
WLCSP-0.64×0.64-4B-A, θ_{JA}	109.1°C/W
WLCSP-0.64×0.64-4B-A, θ_{JB}	33.3°C/W
WLCSP-0.64×0.64-4B-A, θ_{JC}	91.1°C/W
Junction Temperature	+150°C
Storage Temperature Range	-65°C to +150°C
Lead Temperature (Soldering, 10s)	+260°C
ESD Susceptibility	
HBM	8000V
CDM	1000V

RECOMMENDED OPERATING CONDITIONS

Input Voltage Range	1.9V to 5.5V
Enable Input Voltage Range	0V to 5.5V
Input Effective Capacitance, C_{IN}	0.1 μ F (MIN)
Output Effective Capacitance, C_{OUT}	0.5 μ F to 10 μ F
Operating Junction Temperature Range	-40°C to +125°C

OVERSTRESS CAUTION

Stresses beyond those listed in Absolute Maximum Ratings may cause permanent damage to the device. Exposure to absolute maximum rating conditions for extended periods may affect reliability. Functional operation of the device at any conditions beyond those indicated in the Recommended Operating Conditions section is not implied.

ESD SENSITIVITY CAUTION

This integrated circuit can be damaged if ESD protections are not considered carefully. SGMICRO recommends that all integrated circuits be handled with appropriate precautions. Failure to observe proper handling and installation procedures can cause damage. ESD damage can range from subtle performance degradation to complete device failure. Precision integrated circuits may be more susceptible to damage because even small parametric changes could cause the device not to meet the published specifications.

DISCLAIMER

SG Micro Corp reserves the right to make any change in circuit design, or specifications without prior notice.

PIN CONFIGURATION

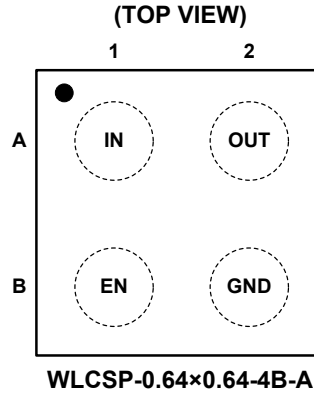

PIN DESCRIPTION

PIN	NAME	FUNCTION
A1	IN	Input Voltage Supply Pin. It is recommended to use a 1µF or larger ceramic capacitor from IN pin to ground to get good power supply decoupling. This ceramic capacitor should be placed as close as possible to IN pin.
A2	OUT	Regulated Output Pin. It is recommended to use a ceramic capacitor with effective capacitance in the range of 0.5µF to 10µF to ensure stability. This ceramic capacitor should be placed as close as possible to OUT pin.
B1	EN	Enable Pin. Drive EN high to turn on the regulator. Drive EN low to turn off the regulator. The EN pin has an internal 0.03µA pull-down current source which ensures that the device is turned off when the EN pin is floated. This pin must be connected to IN pin if enable functionality is not used.
B2	GND	Ground.

FUNCTIONAL BLOCK DIAGRAM

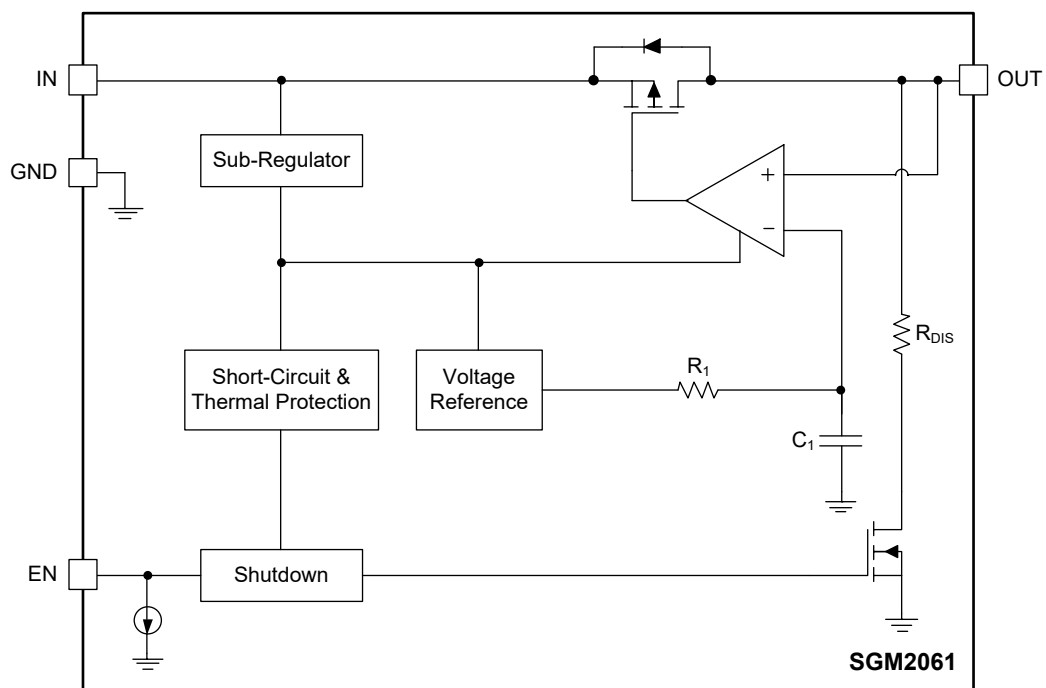

Figure 2. Block Diagram

ELECTRICAL CHARACTERISTICS

($V_{IN} = V_{OUT(NOM)} + 1V$, $V_{EN} = V_{IN}$, $I_{OUT} = 1mA$, $C_{IN} = C_{OUT} = 1\mu F$, $T_J = -40^\circ C$ to $+125^\circ C$, typical values are at $T_J = +25^\circ C$, unless otherwise noted.)

PARAMETER	SYMBOL	CONDITIONS	MIN	TYP	MAX	UNITS
Operating Input Voltage	V_{IN}		1.9		5.5	V
Output Voltage Accuracy	V_{OUT}	$V_{IN} = (V_{OUT(NOM)} + 1V)$ to 5.5V, $I_{OUT} = 1mA$, $T_J = +25^\circ C$	-1		1	%
		$V_{IN} = (V_{OUT(NOM)} + 1V)$ to 5.5V, $I_{OUT} = 1mA$ to 450mA	-2.5		2.5	
Line Regulation	ΔV_{LNR}	$V_{IN} = (V_{OUT(NOM)} + 1V)$ to 5.5V		0.05	2	mV
Load Regulation	$\Delta V_{LDR}/V_{OUT}$	$I_{OUT} = 1mA$ to 450mA		0.4	5	mV/V
Dropout Voltage ⁽¹⁾	V_{DROP}	$I_{OUT} = 450mA$, $V_{OUT(NOM)} = 2.8V$		70	130	mV
Output Current Limit	I_{LIMIT}	$V_{OUT} = 90\% \times V_{OUT(NOM)}$	$T_J = -20^\circ C$ to $+125^\circ C$	450	900	mA
			$T_J = -40^\circ C$ to $+125^\circ C$	400	900	
Short-Circuit Current	I_{SHORT}	$V_{OUT} = 0V$		500		mA
Quiescent Current	I_Q	$I_{OUT} = 0mA$		15	40	μA
Shutdown Current	I_{SHDN}	$V_{EN} = 0V$, $V_{IN} = 5.5V$		0.03	2	μA
EN Pin Threshold Voltage	V_{IH}	$V_{IN} = 1.9V$ to 5.5V	1			V
	V_{IL}	$V_{IN} = 1.9V$ to 5.5V			0.6	
EN Pull-Down Current	I_{EN}	$V_{EN} = 0V$, $V_{IN} = 5.5V$		0.001	1	μA
		$V_{EN} = 5.5V$, $V_{IN} = 5.5V$		0.2	1	
Turn-On Time	t_{ON}	From assertion of V_{EN} to $V_{OUT} = 90\% \times V_{OUT(NOM)}$		100	240	μs
Power Supply Rejection Ratio	PSRR	$I_{OUT} = 20mA$, $V_{IN} = V_{OUT(NOM)} + 1V$, $C_{IN} = 0\mu F$	$f = 100Hz$		90	dB
			$f = 1kHz$		92	
			$f = 10kHz$		80	
			$f = 100kHz$		55	
Output Voltage Noise	e_n	$f = 10Hz$ to 100kHz	$I_{OUT} = 1mA$		10	μV_{RMS}
			$I_{OUT} = 250mA$		9	
Output Discharge Resistance	R_{DIS}	$V_{EN} = 0V$, $V_{OUT} = 0.2V$, $V_{IN} = 3.3V$		270		Ω
Thermal Shutdown Temperature	T_{SHDN}			160		$^\circ C$
Thermal Shutdown Hysteresis	ΔT_{SHDN}			20		$^\circ C$

NOTE:

1. The dropout voltage is defined as the difference between V_{IN} and V_{OUT} when V_{OUT} falls to ($V_{OUT(NOM)} - 50mV$).

TYPICAL PERFORMANCE CHARACTERISTICS

$T_J = +25^\circ\text{C}$, $V_{IN} = V_{OUT(NOM)} + 1\text{V}$, $V_{EN} = V_{IN}$, $C_{IN} = C_{OUT} = 1\mu\text{F}$, unless otherwise noted.

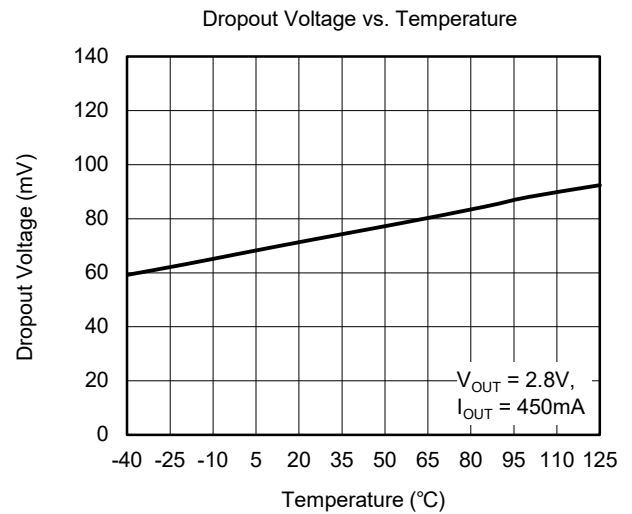
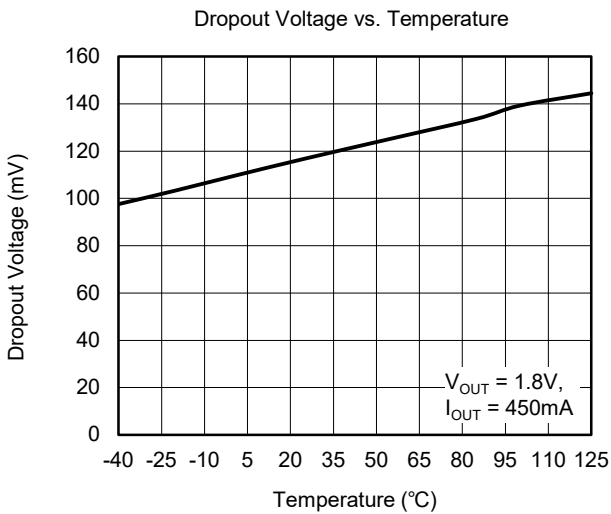
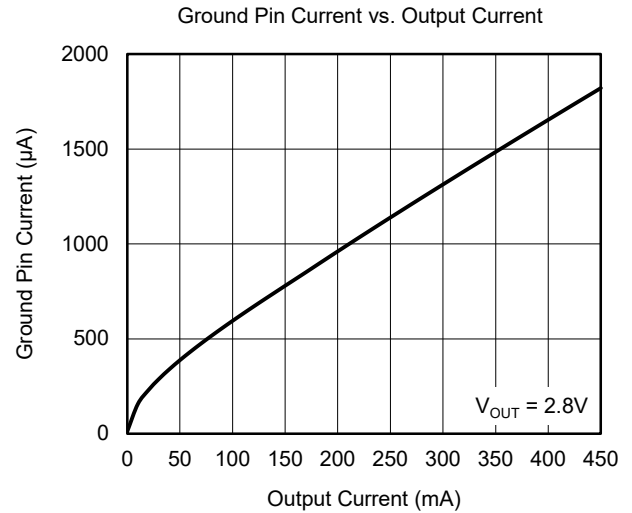
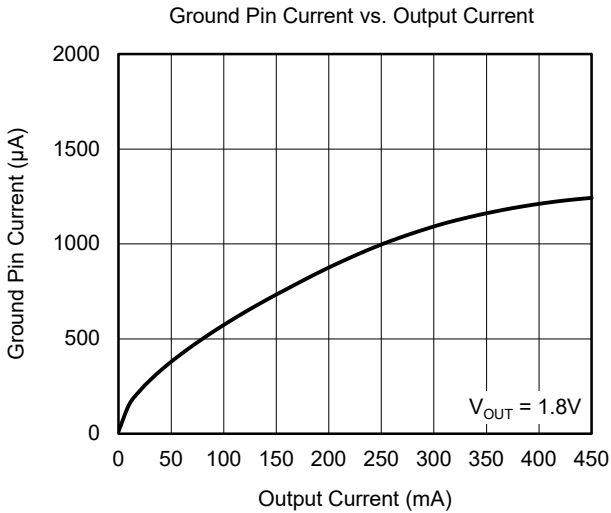
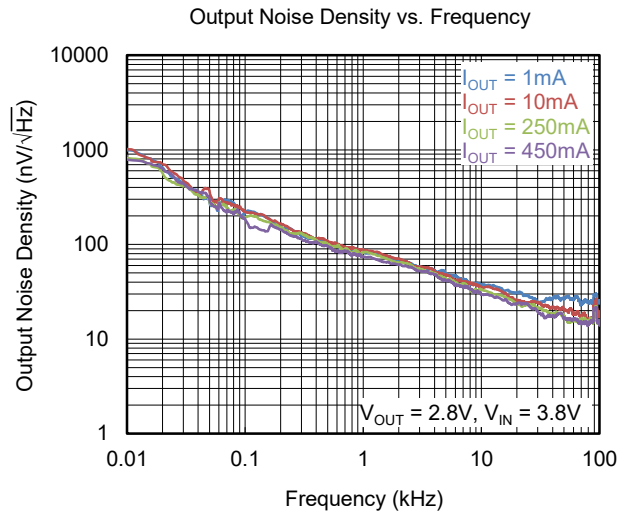
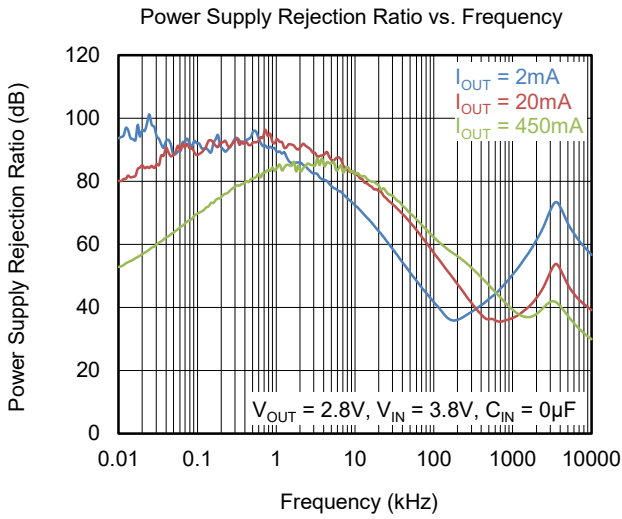

TYPICAL PERFORMANCE CHARACTERISTICS (continued)

$T_J = +25^\circ\text{C}$, $V_{IN} = V_{OUT(NOM)} + 1\text{V}$, $V_{EN} = V_{IN}$, $C_{IN} = C_{OUT} = 1\mu\text{F}$, unless otherwise noted.

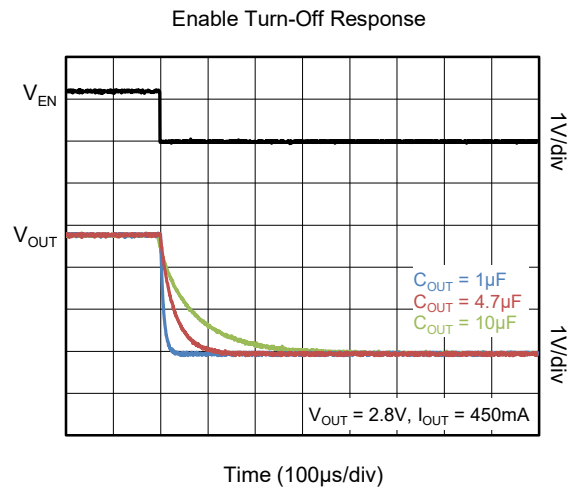
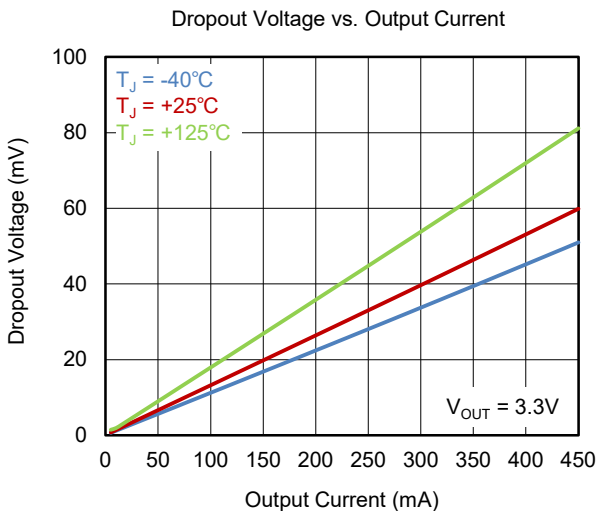
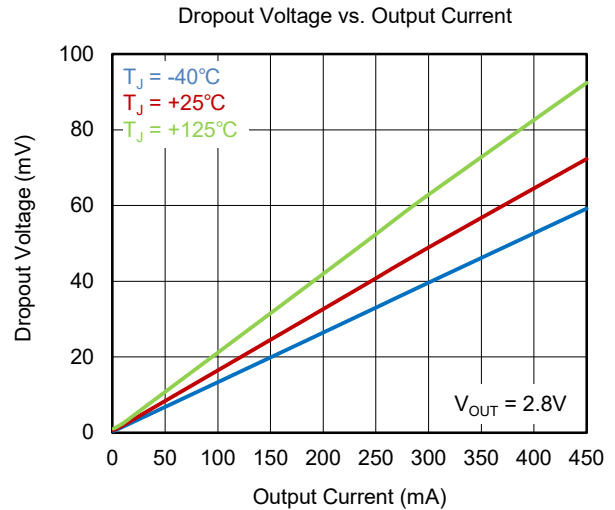
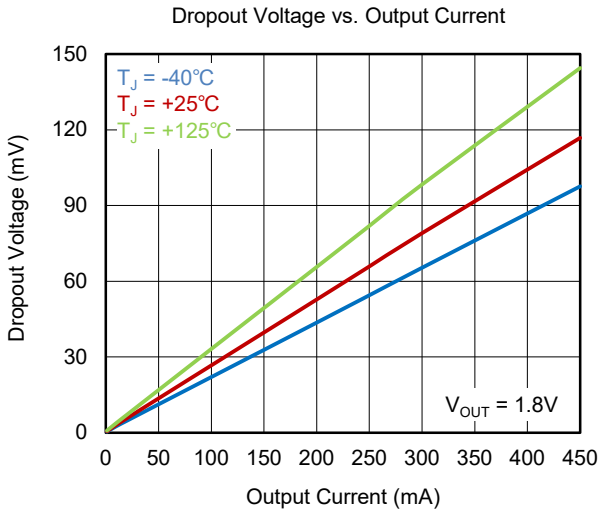
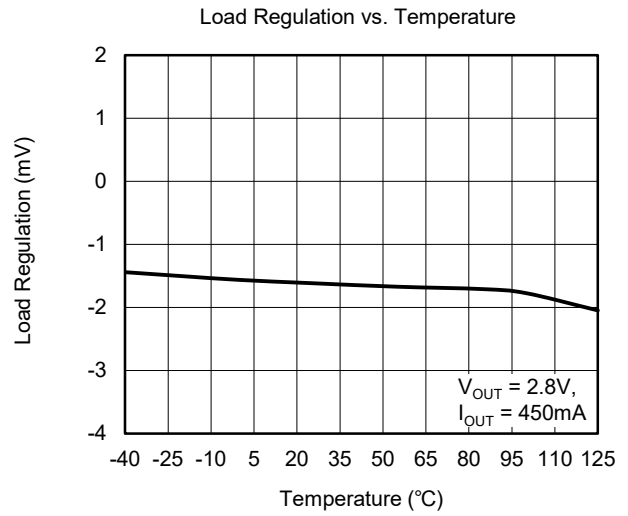
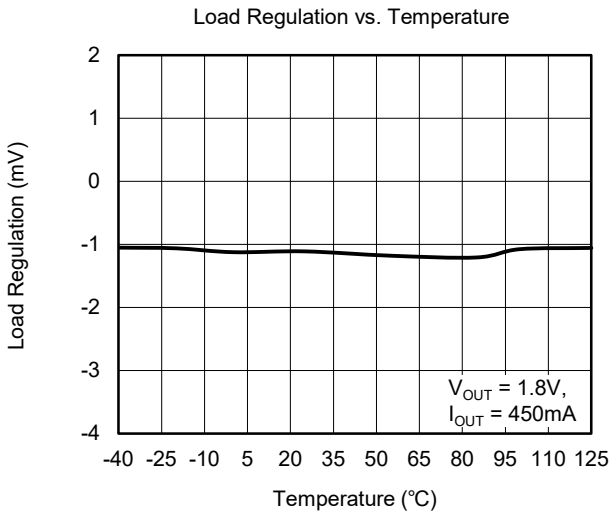

TYPICAL PERFORMANCE CHARACTERISTICS (continued)

$T_J = +25^\circ\text{C}$, $V_{IN} = V_{OUT(NOM)} + 1\text{V}$, $V_{EN} = V_{IN}$, $C_{IN} = C_{OUT} = 1\mu\text{F}$, unless otherwise noted.

Enable Turn-On Response

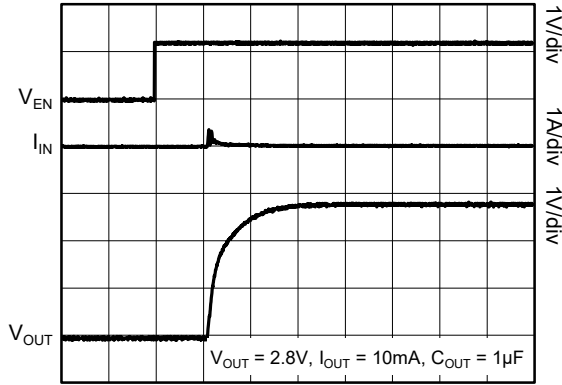

Time (50µs/div)

Enable Turn-On Response

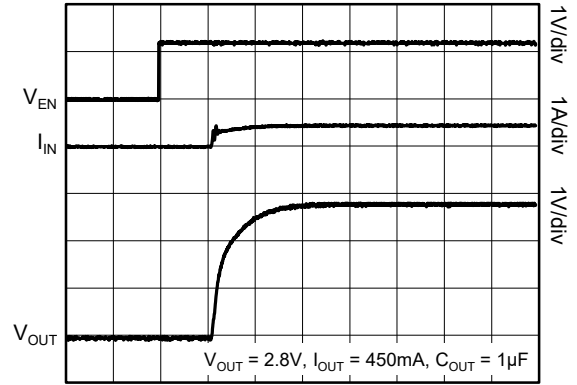

Time (50µs/div)

Enable Turn-On Response

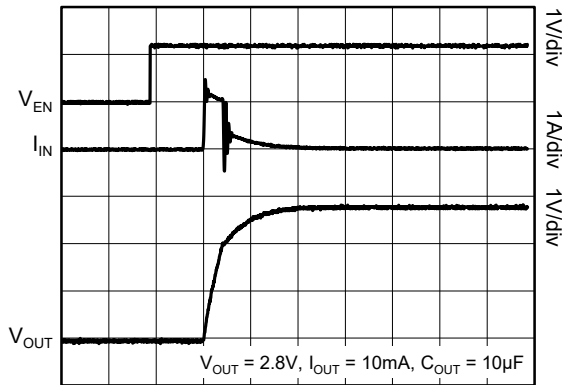

Time (50µs/div)

Enable Turn-On Response

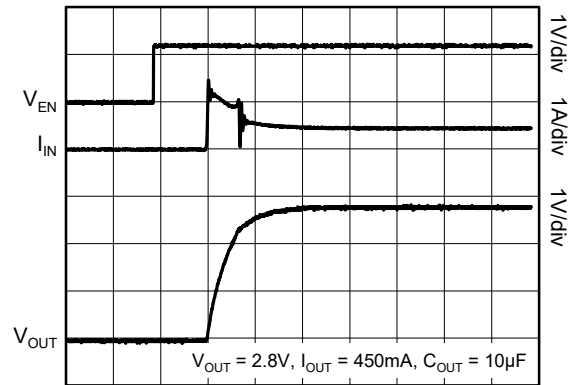

Time (50µs/div)

Line Transient Response

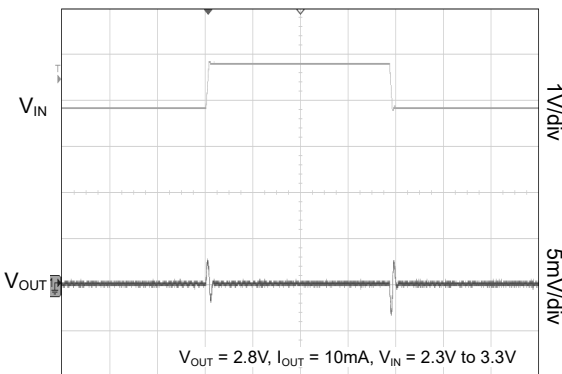

Time (20µs/div)

Line Transient Response

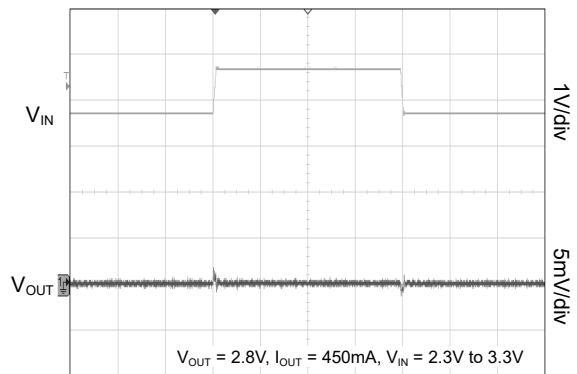

Time (20µs/div)

TYPICAL PERFORMANCE CHARACTERISTICS (continued)

$T_J = +25^\circ\text{C}$, $V_{IN} = V_{OUT(NOM)} + 1\text{V}$, $V_{EN} = V_{IN}$, $C_{IN} = C_{OUT} = 1\mu\text{F}$, unless otherwise noted.

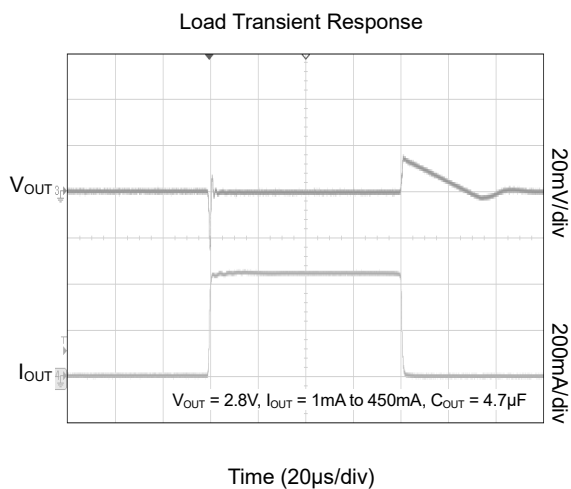
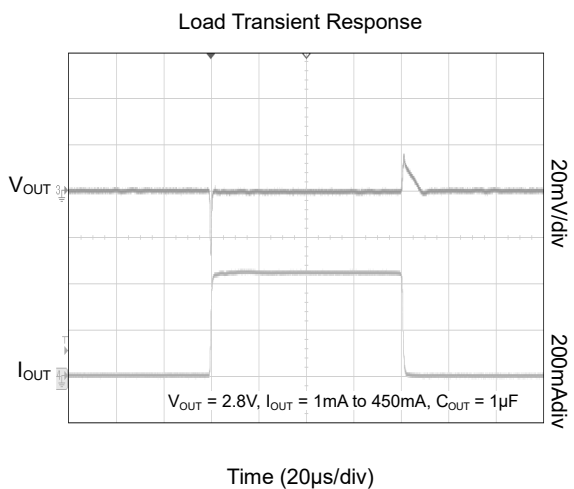

APPLICATION INFORMATION

The SGM2061 is an ultra-low noise and low dropout LDO and provides 450mA output current. These features make the device a reliable solution to solve many challenging problems in the generation of clean and accurate power supply. The high performance also makes the SGM2061 useful in a variety of applications. The SGM2061 provides the protection functions for output overload, output short-circuit condition and overheating.

The SGM2061 provides an EN pin as an external chip enable control to enable/disable the device. When the regulator is in shutdown state, the shutdown current consumes as low as 0.03 μ A (TYP).

Input Capacitor Selection (C_{IN})

The input decoupling capacitor should be placed as close as possible to the IN pin for ensuring the device stability. 1 μ F or larger X7R or X5R ceramic capacitor is selected to get good dynamic performance.

When V_{IN} is required to provide large current instantaneously, a large effective input capacitor is required. Multiple input capacitors can limit the input tracking inductance. Adding more input capacitors is available to restrict the ringing and to keep it below the device absolute maximum ratings. For C_{OUT} with larger capacitance, it is recommended to choose the larger capacitance C_{IN} .

Output Capacitor Selection (C_{OUT})

One or more output capacitors are required to maintain the stability of the LDO, and the output capacitors should be placed as close as possible to the OUT pin. In addition, in order to obtain the best transient performance, it is recommended to use X7R and X5R ceramic capacitors as output capacitors. Ceramic capacitors have low equivalent series resistance (ESR), excellent temperature and DC bias characteristics. However, it cannot be ignored that the effective capacitance of ceramic capacitors is affected by temperature, DC bias and package size.

For example, Figure 1 shows the capacitance and DC bias and temperature characteristics of 0805, 10V, 10 μ F \pm 10%, X7R capacitor. Therefore, it is necessary to evaluate whether the effective capacitance of the output capacitor can meet the stability requirements of the LDO in practical applications. In general, a

capacitor in higher voltage rating and a larger package exhibits better stability, and the effective capacitance can be obtained from the manufacturer datasheet.

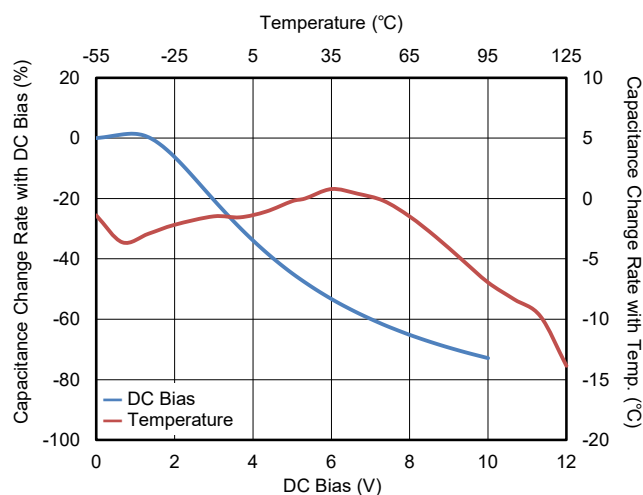

Figure 3. Capacitance vs. DC Bias and Temperature Characteristics

The SGM2061 requires a minimum effective capacitance of 0.5 μ F for C_{OUT} to ensure stability. Additionally, C_{OUT} with larger capacitance and lower ESR will help increase the high frequency PSRR and improve the load transient response.

Enable Control

The EN pin of the SGM2061 is used to enable/disable its device and to deactivate/activate the output automatic discharge function.

When the EN pin voltage is lower than 0.6V, the device is in shutdown state. There is no current flowing from IN to OUT pins. In this state, the automatic discharge transistor is active to discharge the output voltage through a 270 Ω (TYP) resistor.

When the EN pin voltage is higher than 1V, the device is in active state. The input voltage is regulated to the output voltage and the automatic discharge transistor is turned off.

The EN pin is pulled down by internal 0.03 μ A (TYP) current source when the EN pin is floated. This current source will ensure the SGM2061 in shutdown state and reduce the power dissipation in system.

APPLICATION INFORMATION (continued)

Reverse Current Protection

The power transistor has an inherent body diode. This body diode will be forward biased when $V_{OUT} > (V_{IN} + 0.3V)$. When $V_{OUT} > (V_{IN} + 0.3V)$, the reverse current flowing from the OUT pin to the IN pin will damage the SGM2061. If $V_{OUT} > (V_{IN} + 0.3V)$ event would happen in system, one external Schottky diode will be added between OUT pin and IN pin in circuit design to protect the SGM2061.

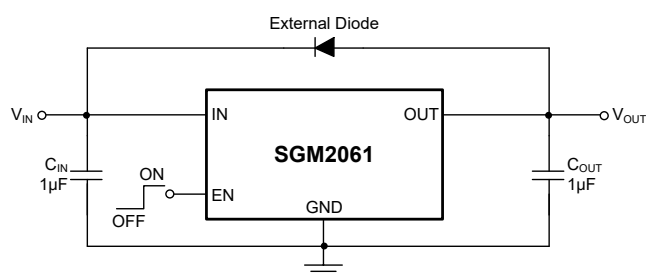

Figure 4. Reverse Protection Reference Design

Negatively Biased Output

When the output voltage is negative, the chip may not start up due to parasitic effects. Ensure that the output is greater than $-0.3V$ under all conditions. If negatively biased output is excessive and expected in the application, a Schottky diode can be added between the OUT pin and GND pin.

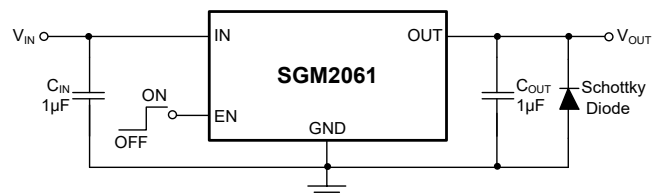

Figure 5. Negatively Biased Output Application

Output Current Limit and Short-Circuit Protection

When overload events happen, the output current is internally limited to 900mA (TYP). When the OUT pin is shorted to ground, the short-circuit protection will limit the output current to 500mA (TYP).

Thermal Shutdown

When the die temperature exceeds the threshold value of thermal shutdown, the SGM2061 will be in shutdown state and it will remain in this state until the die temperature decreases to $+140^{\circ}C$.

Power Dissipation (P_D)

Power dissipation (P_D) of the SGM2061 can be calculated by the equation $P_D = (V_{IN} - V_{OUT}) \times I_{OUT}$. The maximum allowable power dissipation ($P_{D(MAX)}$) of the SGM2061 is affected by many factors, including the difference between junction temperature and ambient temperature ($T_{J(MAX)} - T_A$), package thermal resistance from the junction to the ambient environment (θ_{JA}), the rate of ambient airflow and PCB layout. $P_{D(MAX)}$ can be approximated by the following equation:

$$P_{D(MAX)} = (T_{J(MAX)} - T_A) / \theta_{JA} \quad (1)$$

REVISION HISTORY

NOTE: Page numbers for previous revisions may differ from page numbers in the current version.

MARCH 2026 – REV.A.3 to REV.A.4	Page
Added SGM2061-2.55XG/TR to Package/Ordering Information section	2
<hr/>	
MAY 2025 – REV.A.2 to REV.A.3	Page
Updated Typical Performance Characteristics	6, 7, 8, 9
<hr/>	
JULY 2024 – REV.A.1 to REV.A.2	Page
Updated Package Thermal Resistance	2
Updated Application Information section	10, 11
<hr/>	
OCTOBER 2021 – REV.A to REV.A.1	Page
Updated Electrical Characteristics section	4
Updated Typical Performance Characteristics section	5
<hr/>	
Changes from Original (SEPTEMBER 2021) to REV.A	Page
Changed from product preview to production data	All

PACKAGE OUTLINE DIMENSIONS

WLCSP-0.64x0.64-4B-A

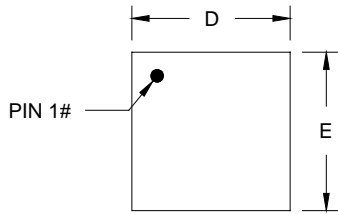

TOP VIEW

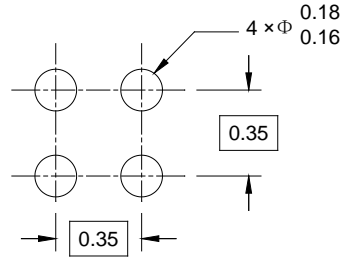

RECOMMENDED LAND PATTERN (Unit: mm)

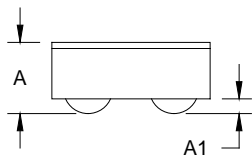

SIDE VIEW

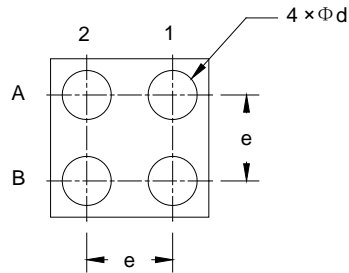

BOTTOM VIEW

Symbol	Dimensions In Millimeters		
	MIN	MOD	MAX
A	0.262	0.290	0.318
A1	0.050	0.060	0.070
D	0.620	0.645	0.670
E	0.620	0.645	0.670
d	0.190	0.200	0.210
e	0.350 BSC		

NOTE: This drawing is subject to change without notice.

PACKAGE INFORMATION

TAPE AND REEL INFORMATION

REEL DIMENSIONS

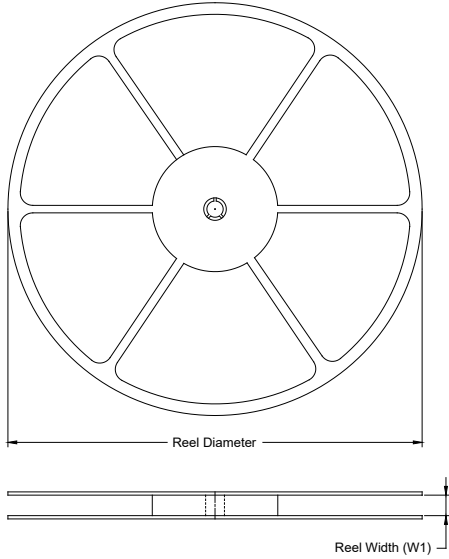

TAPE DIMENSIONS

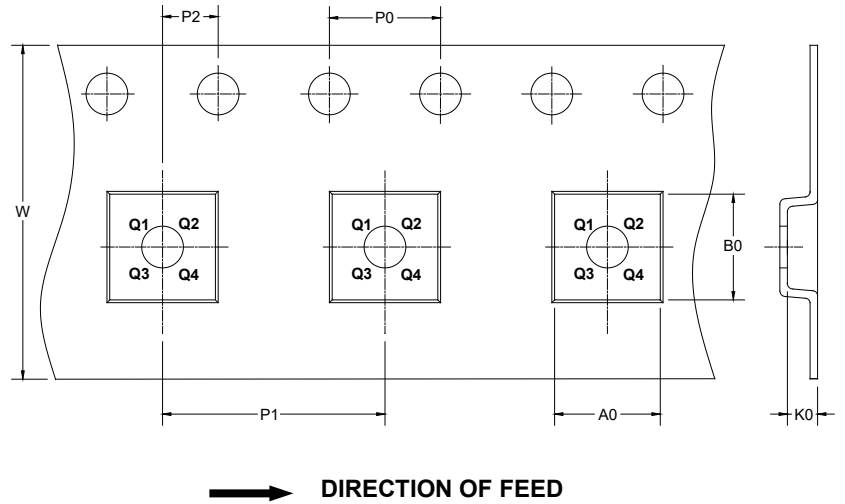

NOTE: The picture is only for reference. Please make the object as the standard.

KEY PARAMETER LIST OF TAPE AND REEL

Package Type	Reel Diameter	Reel Width W1 (mm)	A0 (mm)	B0 (mm)	K0 (mm)	P0 (mm)	P1 (mm)	P2 (mm)	W (mm)	Pin1 Quadrant
WLCSP-0.64×0.64-4B-A	7"	9.5	0.74	0.74	0.37	4.0	4.0	2.0	8.0	Q1

DD00001

PACKAGE INFORMATION

CARTON BOX DIMENSIONS

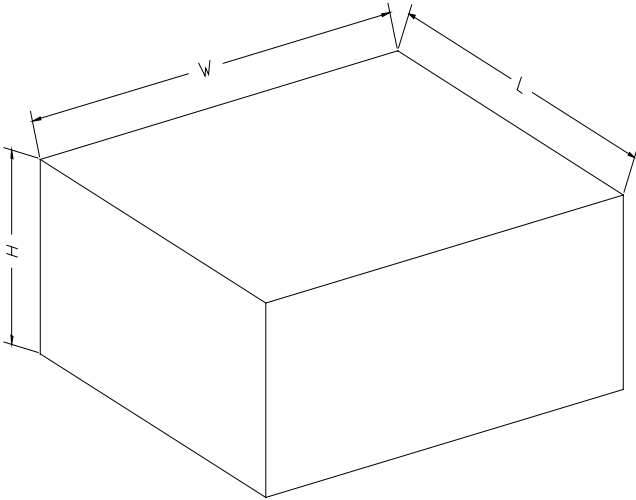

NOTE: The picture is only for reference. Please make the object as the standard.

KEY PARAMETER LIST OF CARTON BOX

Reel Type	Length (mm)	Width (mm)	Height (mm)	Pizza/Carton
7" (Option)	368	227	224	8
7"	442	410	224	18

DD0002