

GENERAL DESCRIPTION

The SGM818 is a low power consumption voltage detector with high accuracy detection. It operates with a supply voltage (V_{DD}) range from 0.9V to 6V. It can provide circuit initialization for DSP-based and processor-based systems. The SGM818 offers tremendous flexibility with an adjustable threshold that is available from 1.2V to 5.0V with 0.1V increments.

Whenever V_{DD} falls below a factory preset threshold level (V_{TH}), the device will send out a reset signal. This signal will last the whole period until V_{DD} recovers. Once V_{DD} exceeds the release voltage ($V_{TH} + V_{HYS}$), the reset signal will maintain a certain delay time and be released.

The SGM818 is available in a Green SOT-23-3 package. It is specified over the -40°C to $+125^{\circ}\text{C}$ operating temperature range.

FEATURES

- High Accuracy: $\pm 1\%$ at $T_J = +25^{\circ}\text{C}$
- Low Supply Current: $1\mu\text{A}$ (TYP)
- Detection Voltage Range: 1.2V to 5.0V (0.1V Increments)
- No External Components Required
- Quick Reset within $37\mu\text{s}$ (TYP)
- Reset Active Timeout Period
 - ♦ SGM818A: 0.8ms (nRESET)
 - ♦ SGM818B: 51ms (nRESET)
 - ♦ SGM818C: 208ms (nRESET)
 - ♦ SGM818D: 409ms (nRESET)
 - ♦ SGM818E: 0.8ms (RESET)
 - ♦ SGM818F: 51ms (RESET)
 - ♦ SGM818G: 208ms (RESET)
 - ♦ SGM818H: 409ms (RESET)
- Low Functional Supply Voltage: 0.9V
- N-Channel Open-Drain Output
- Available in a Green SOT-23-3 Package

TYPICAL APPLICATION

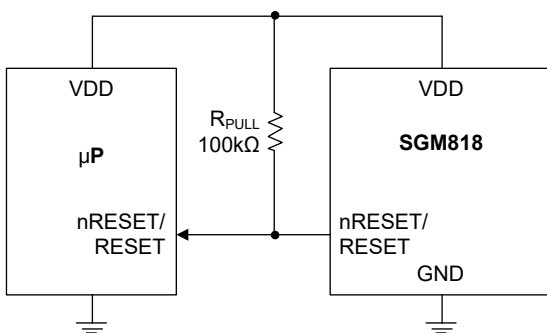

Figure 1. Typical Application Circuit

APPLICATIONS

- Computers
- Controllers
- Intelligent Instruments
- Portable Equipment
- μC Power Monitoring
- Battery-Powered Equipment

PACKAGE/ORDERING INFORMATION

MODEL	THRESHOLD VOLTAGE (V)	PACKAGE DESCRIPTION	SPECIFIED TEMPERATURE RANGE	ORDERING NUMBER	PACKAGE MARKING	PACKING OPTION
SGM818A-1.2	1.2	SOT-23-3	-40°C to +125°C	SGM818A-1.2XN3G/TR	GKHXX	Tape and Reel, 3000
		SOT-23-3 (L-Type)	-40°C to +125°C	SGM818A-1.2LXN3G/TR	GKIXX	Tape and Reel, 3000
SGM818A-1.4	1.4	SOT-23-3	-40°C to +125°C	SGM818A-1.4XN3G/TR	GKLXX	Tape and Reel, 3000
		SOT-23-3 (L-Type)	-40°C to +125°C	SGM818A-1.4LXN3G/TR	GKMXX	Tape and Reel, 3000
SGM818A-1.6	1.6	SOT-23-3	-40°C to +125°C	SGM818A-1.6XN3G/TR	GKQXX	Tape and Reel, 3000
		SOT-23-3 (L-Type)	-40°C to +125°C	SGM818A-1.6LXN3G/TR	GKRXX	Tape and Reel, 3000
SGM818A-1.8	1.8	SOT-23-3	-40°C to +125°C	SGM818A-1.8XN3G/TR	GKUXX	Tape and Reel, 3000
		SOT-23-3 (L-Type)	-40°C to +125°C	SGM818A-1.8LXN3G/TR	GKVXX	Tape and Reel, 3000
SGM818A-2.0	2	SOT-23-3	-40°C to +125°C	SGM818A-2.0XN3G/TR	GKYXX	Tape and Reel, 3000
		SOT-23-3 (L-Type)	-40°C to +125°C	SGM818A-2.0LXN3G/TR	GKZXX	Tape and Reel, 3000
SGM818A-2.2	2.2	SOT-23-3	-40°C to +125°C	SGM818A-2.2XN3G/TR	GL3XX	Tape and Reel, 3000
		SOT-23-3 (L-Type)	-40°C to +125°C	SGM818A-2.2LXN3G/TR	GL5XX	Tape and Reel, 3000
SGM818A-2.3	2.3	SOT-23-3	-40°C to +125°C	SGM818A-2.3XN3G/TR	GL8XX	Tape and Reel, 3000
		SOT-23-3 (L-Type)	-40°C to +125°C	SGM818A-2.3LXN3G/TR	GLBXX	Tape and Reel, 3000
SGM818A-2.5	2.5	SOT-23-3	-40°C to +125°C	SGM818A-2.5XN3G/TR	GLHXX	Tape and Reel, 3000
		SOT-23-3 (L-Type)	-40°C to +125°C	SGM818A-2.5LXN3G/TR	GLIXX	Tape and Reel, 3000
SGM818A-2.7	2.7	SOT-23-3	-40°C to +125°C	SGM818A-2.7XN3G/TR	GLLXX	Tape and Reel, 3000
		SOT-23-3 (L-Type)	-40°C to +125°C	SGM818A-2.7LXN3G/TR	GLMXX	Tape and Reel, 3000
SGM818A-2.8	2.8	SOT-23-3	-40°C to +125°C	SGM818A-2.8XN3G/TR	G5ZXX	Tape and Reel, 3000
		SOT-23-3 (L-Type)	-40°C to +125°C	SGM818A-2.8LXN3G/TR	GLNXX	Tape and Reel, 3000
SGM818A-2.9	2.9	SOT-23-3	-40°C to +125°C	SGM818A-2.9XN3G/TR	GLPXX	Tape and Reel, 3000
		SOT-23-3 (L-Type)	-40°C to +125°C	SGM818A-2.9LXN3G/TR	GLQXX	Tape and Reel, 3000
SGM818A-3.0	3	SOT-23-3	-40°C to +125°C	SGM818A-3.0XN3G/TR	GLRXX	Tape and Reel, 3000
		SOT-23-3 (L-Type)	-40°C to +125°C	SGM818A-3.0LXN3G/TR	GLSXX	Tape and Reel, 3000
SGM818A-3.3	3.3	SOT-23-3	-40°C to +125°C	SGM818A-3.3XN3G/TR	GLXXX	Tape and Reel, 3000
		SOT-23-3 (L-Type)	-40°C to +125°C	SGM818A-3.3LXN3G/TR	GLYXX	Tape and Reel, 3000
SGM818A-3.9	3.9	SOT-23-3	-40°C to +125°C	SGM818A-3.9XN3G/TR	GMQXX	Tape and Reel, 3000
		SOT-23-3 (L-Type)	-40°C to +125°C	SGM818A-3.9LXN3G/TR	GMRXX	Tape and Reel, 3000
SGM818A-4.6	4.6	SOT-23-3	-40°C to +125°C	SGM818A-4.6XN3G/TR	GNLXX	Tape and Reel, 3000
		SOT-23-3 (L-Type)	-40°C to +125°C	SGM818A-4.6LXN3G/TR	GNMXX	Tape and Reel, 3000
SGM818A-5.0	5	SOT-23-3	-40°C to +125°C	SGM818A-5.0XN3G/TR	GNUXX	Tape and Reel, 3000
		SOT-23-3 (L-Type)	-40°C to +125°C	SGM818A-5.0LXN3G/TR	GNVXX	Tape and Reel, 3000
SGM818B-1.2	1.2	SOT-23-3	-40°C to +125°C	SGM818B-1.2XN3G/TR	G6UXX	Tape and Reel, 3000
		SOT-23-3 (L-Type)	-40°C to +125°C	SGM818B-1.2LXN3G/TR	GNWXX	Tape and Reel, 3000

PACKAGE/ORDERING INFORMATION (continued)

MODEL	THRESHOLD VOLTAGE (V)	PACKAGE DESCRIPTION	SPECIFIED TEMPERATURE RANGE	ORDERING NUMBER	PACKAGE MARKING	PACKING OPTION
SGM818B-1.4	1.4	SOT-23-3	-40°C to +125°C	SGM818B-1.4XN3G/TR	GNZXX	Tape and Reel, 3000
		SOT-23-3 (L-Type)	-40°C to +125°C	SGM818B-1.4LXN3G/TR	GPFXX	Tape and Reel, 3000
SGM818B-1.6	1.6	SOT-23-3	-40°C to +125°C	SGM818B-1.6XN3G/TR	GPIXX	Tape and Reel, 3000
		SOT-23-3 (L-Type)	-40°C to +125°C	SGM818B-1.6LXN3G/TR	GPJXX	Tape and Reel, 3000
SGM818B-1.8	1.8	SOT-23-3	-40°C to +125°C	SGM818B-1.8XN3G/TR	GPMXX	Tape and Reel, 3000
		SOT-23-3 (L-Type)	-40°C to +125°C	SGM818B-1.8LXN3G/TR	GPNXX	Tape and Reel, 3000
SGM818B-2.0	2	SOT-23-3	-40°C to +125°C	SGM818B-2.0XN3G/TR	GPRXX	Tape and Reel, 3000
		SOT-23-3 (L-Type)	-40°C to +125°C	SGM818B-2.0LXN3G/TR	GPSXX	Tape and Reel, 3000
SGM818B-2.2	2.2	SOT-23-3	-40°C to +125°C	SGM818B-2.2XN3G/TR	GPVXX	Tape and Reel, 3000
		SOT-23-3 (L-Type)	-40°C to +125°C	SGM818B-2.2LXN3G/TR	GPWXX	Tape and Reel, 3000
SGM818B-2.3	2.3	SOT-23-3	-40°C to +125°C	SGM818B-2.3XN3G/TR	GPXXX	Tape and Reel, 3000
		SOT-23-3 (L-Type)	-40°C to +125°C	SGM818B-2.3LXN3G/TR	GPYXX	Tape and Reel, 3000
SGM818B-2.5	2.5	SOT-23-3	-40°C to +125°C	SGM818B-2.5XN3G/TR	GQ1XX	Tape and Reel, 3000
		SOT-23-3 (L-Type)	-40°C to +125°C	SGM818B-2.5LXN3G/TR	GQ2XX	Tape and Reel, 3000
SGM818B-2.7	2.7	SOT-23-3	-40°C to +125°C	SGM818B-2.7XN3G/TR	GQ5XX	Tape and Reel, 3000
		SOT-23-3 (L-Type)	-40°C to +125°C	SGM818B-2.7LXN3G/TR	GQ6XX	Tape and Reel, 3000
SGM818B-2.8	2.8	SOT-23-3	-40°C to +125°C	SGM818B-2.8XN3G/TR	GQ7XX	Tape and Reel, 3000
		SOT-23-3 (L-Type)	-40°C to +125°C	SGM818B-2.8LXN3G/TR	GQ8XX	Tape and Reel, 3000
SGM818B-2.9	2.9	SOT-23-3	-40°C to +125°C	SGM818B-2.9XN3G/TR	GQ9XX	Tape and Reel, 3000
		SOT-23-3 (L-Type)	-40°C to +125°C	SGM818B-2.9LXN3G/TR	GQAXX	Tape and Reel, 3000
SGM818B-3.0	3	SOT-23-3	-40°C to +125°C	SGM818B-3.0XN3G/TR	GQBXX	Tape and Reel, 3000
		SOT-23-3 (L-Type)	-40°C to +125°C	SGM818B-3.0LXN3G/TR	GQCXX	Tape and Reel, 3000
SGM818B-3.3	3.3	SOT-23-3	-40°C to +125°C	SGM818B-3.3XN3G/TR	GQHXX	Tape and Reel, 3000
		SOT-23-3 (L-Type)	-40°C to +125°C	SGM818B-3.3LXN3G/TR	GQIXX	Tape and Reel, 3000
SGM818B-3.9	3.9	SOT-23-3	-40°C to +125°C	SGM818B-3.9XN3G/TR	GQTXX	Tape and Reel, 3000
		SOT-23-3 (L-Type)	-40°C to +125°C	SGM818B-3.9LXN3G/TR	GQUXX	Tape and Reel, 3000
SGM818B-4.6	4.6	SOT-23-3	-40°C to +125°C	SGM818B-4.6XN3G/TR	GRLXX	Tape and Reel, 3000
		SOT-23-3 (L-Type)	-40°C to +125°C	SGM818B-4.6LXN3G/TR	GRMXX	Tape and Reel, 3000
SGM818B-5.0	5	SOT-23-3	-40°C to +125°C	SGM818B-5.0XN3G/TR	G6XXX	Tape and Reel, 3000
		SOT-23-3 (L-Type)	-40°C to +125°C	SGM818B-5.0LXN3G/TR	GRUXX	Tape and Reel, 3000
SGM818C-1.2	1.2	SOT-23-3	-40°C to +125°C	SGM818C-1.2XN3G/TR	GRVXX	Tape and Reel, 3000
		SOT-23-3 (L-Type)	-40°C to +125°C	SGM818C-1.2LXN3G/TR	GRWXX	Tape and Reel, 3000
SGM818C-1.4	1.4	SOT-23-3	-40°C to +125°C	SGM818C-1.4XN3G/TR	GRZXX	Tape and Reel, 3000
		SOT-23-3 (L-Type)	-40°C to +125°C	SGM818C-1.4LXN3G/TR	GSBXX	Tape and Reel, 3000

PACKAGE/ORDERING INFORMATION (continued)

MODEL	THRESHOLD VOLTAGE (V)	PACKAGE DESCRIPTION	SPECIFIED TEMPERATURE RANGE	ORDERING NUMBER	PACKAGE MARKING	PACKING OPTION
SGM818C-1.6	1.6	SOT-23-3	-40°C to +125°C	SGM818C-1.6XN3G/TR	GSIXX	Tape and Reel, 3000
		SOT-23-3 (L-Type)	-40°C to +125°C	SGM818C-1.6LXN3G/TR	GSJXX	Tape and Reel, 3000
SGM818C-1.8	1.8	SOT-23-3	-40°C to +125°C	SGM818C-1.8XN3G/TR	GSMXX	Tape and Reel, 3000
		SOT-23-3 (L-Type)	-40°C to +125°C	SGM818C-1.8LXN3G/TR	GSNXX	Tape and Reel, 3000
SGM818C-2.0	2	SOT-23-3	-40°C to +125°C	SGM818C-2.0XN3G/TR	GSRXX	Tape and Reel, 3000
		SOT-23-3 (L-Type)	-40°C to +125°C	SGM818C-2.0LXN3G/TR	GSSXX	Tape and Reel, 3000
SGM818C-2.2	2.2	SOT-23-3	-40°C to +125°C	SGM818C-2.2XN3G/TR	GSVXX	Tape and Reel, 3000
		SOT-23-3 (L-Type)	-40°C to +125°C	SGM818C-2.2LXN3G/TR	GSWXX	Tape and Reel, 3000
SGM818C-2.3	2.3	SOT-23-3	-40°C to +125°C	SGM818C-2.3XN3G/TR	GSXXX	Tape and Reel, 3000
		SOT-23-3 (L-Type)	-40°C to +125°C	SGM818C-2.3LXN3G/TR	GSYXX	Tape and Reel, 3000
SGM818C-2.5	2.5	SOT-23-3	-40°C to +125°C	SGM818C-2.5XN3G/TR	GTGXX	Tape and Reel, 3000
		SOT-23-3 (L-Type)	-40°C to +125°C	SGM818C-2.5LXN3G/TR	GTHXX	Tape and Reel, 3000
SGM818C-2.7	2.7	SOT-23-3	-40°C to +125°C	SGM818C-2.7XN3G/TR	GTKXX	Tape and Reel, 3000
		SOT-23-3 (L-Type)	-40°C to +125°C	SGM818C-2.7LXN3G/TR	GTLXX	Tape and Reel, 3000
SGM818C-2.8	2.8	SOT-23-3	-40°C to +125°C	SGM818C-2.8XN3G/TR	GTMXX	Tape and Reel, 3000
		SOT-23-3 (L-Type)	-40°C to +125°C	SGM818C-2.8LXN3G/TR	GTNXX	Tape and Reel, 3000
SGM818C-2.9	2.9	SOT-23-3	-40°C to +125°C	SGM818C-2.9XN3G/TR	GTPXX	Tape and Reel, 3000
		SOT-23-3 (L-Type)	-40°C to +125°C	SGM818C-2.9LXN3G/TR	GTQXX	Tape and Reel, 3000
SGM818C-3.0	3	SOT-23-3	-40°C to +125°C	SGM818C-3.0XN3G/TR	GTRXX	Tape and Reel, 3000
		SOT-23-3 (L-Type)	-40°C to +125°C	SGM818C-3.0LXN3G/TR	GTSXX	Tape and Reel, 3000
SGM818C-3.3	3.3	SOT-23-3	-40°C to +125°C	SGM818C-3.3XN3G/TR	GTXXX	Tape and Reel, 3000
		SOT-23-3 (L-Type)	-40°C to +125°C	SGM818C-3.3LXN3G/TR	GTYXX	Tape and Reel, 3000
SGM818C-3.9	3.9	SOT-23-3	-40°C to +125°C	SGM818C-3.9XN3G/TR	GUGXX	Tape and Reel, 3000
		SOT-23-3 (L-Type)	-40°C to +125°C	SGM818C-3.9LXN3G/TR	GUHXX	Tape and Reel, 3000
SGM818C-4.6	4.6	SOT-23-3	-40°C to +125°C	SGM818C-4.6XN3G/TR	GUVXX	Tape and Reel, 3000
		SOT-23-3 (L-Type)	-40°C to +125°C	SGM818C-4.6LXN3G/TR	GUWXX	Tape and Reel, 3000
SGM818C-5.0	5	SOT-23-3	-40°C to +125°C	SGM818C-5.0XN3G/TR	GVIXX	Tape and Reel, 3000
		SOT-23-3 (L-Type)	-40°C to +125°C	SGM818C-5.0LXN3G/TR	GVJXX	Tape and Reel, 3000
SGM818D-1.2	1.2	SOT-23-3	-40°C to +125°C	SGM818D-1.2XN3G/TR	GVKXX	Tape and Reel, 3000
		SOT-23-3 (L-Type)	-40°C to +125°C	SGM818D-1.2LXN3G/TR	GVLXX	Tape and Reel, 3000
SGM818D-1.4	1.4	SOT-23-3	-40°C to +125°C	SGM818D-1.4XN3G/TR	GVPXX	Tape and Reel, 3000
		SOT-23-3 (L-Type)	-40°C to +125°C	SGM818D-1.4LXN3G/TR	GVQXX	Tape and Reel, 3000
SGM818D-1.6	1.6	SOT-23-3	-40°C to +125°C	SGM818D-1.6XN3G/TR	GVTXX	Tape and Reel, 3000
		SOT-23-3 (L-Type)	-40°C to +125°C	SGM818D-1.6LXN3G/TR	GVUXX	Tape and Reel, 3000

PACKAGE/ORDERING INFORMATION (continued)

MODEL	THRESHOLD VOLTAGE (V)	PACKAGE DESCRIPTION	SPECIFIED TEMPERATURE RANGE	ORDERING NUMBER	PACKAGE MARKING	PACKING OPTION
SGM818D-1.8	1.8	SOT-23-3	-40°C to +125°C	SGM818D-1.8XN3G/TR	GVXXX	Tape and Reel, 3000
		SOT-23-3 (L-Type)	-40°C to +125°C	SGM818D-1.8LXN3G/TR	GVYXX	Tape and Reel, 3000
SGM818D-2.0	2	SOT-23-3	-40°C to +125°C	SGM818D-2.0XN3G/TR	GW5XX	Tape and Reel, 3000
		SOT-23-3 (L-Type)	-40°C to +125°C	SGM818D-2.0LXN3G/TR	GWDXX	Tape and Reel, 3000
SGM818D-2.2	2.2	SOT-23-3	-40°C to +125°C	SGM818D-2.2XN3G/TR	GWGXX	Tape and Reel, 3000
		SOT-23-3 (L-Type)	-40°C to +125°C	SGM818D-2.2LXN3G/TR	GWHXX	Tape and Reel, 3000
SGM818D-2.3	2.3	SOT-23-3	-40°C to +125°C	SGM818D-2.3XN3G/TR	GWIXX	Tape and Reel, 3000
		SOT-23-3 (L-Type)	-40°C to +125°C	SGM818D-2.3LXN3G/TR	GWJXX	Tape and Reel, 3000
SGM818D-2.5	2.5	SOT-23-3	-40°C to +125°C	SGM818D-2.5XN3G/TR	GWMXX	Tape and Reel, 3000
		SOT-23-3 (L-Type)	-40°C to +125°C	SGM818D-2.5LXN3G/TR	GWNXX	Tape and Reel, 3000
SGM818D-2.7	2.7	SOT-23-3	-40°C to +125°C	SGM818D-2.7XN3G/TR	GWRXX	Tape and Reel, 3000
		SOT-23-3 (L-Type)	-40°C to +125°C	SGM818D-2.7LXN3G/TR	GWSXX	Tape and Reel, 3000
SGM818D-2.8	2.8	SOT-23-3	-40°C to +125°C	SGM818D-2.8XN3G/TR	GWTXX	Tape and Reel, 3000
		SOT-23-3 (L-Type)	-40°C to +125°C	SGM818D-2.8LXN3G/TR	GWUXX	Tape and Reel, 3000
SGM818D-2.9	2.9	SOT-23-3	-40°C to +125°C	SGM818D-2.9XN3G/TR	GWVXX	Tape and Reel, 3000
		SOT-23-3 (L-Type)	-40°C to +125°C	SGM818D-2.9LXN3G/TR	GWVXX	Tape and Reel, 3000
SGM818D-3.0	3	SOT-23-3	-40°C to +125°C	SGM818D-3.0XN3G/TR	GWXXX	Tape and Reel, 3000
		SOT-23-3 (L-Type)	-40°C to +125°C	SGM818D-3.0LXN3G/TR	GWYXX	Tape and Reel, 3000
SGM818D-3.3	3.3	SOT-23-3	-40°C to +125°C	SGM818D-3.3XN3G/TR	GXIXX	Tape and Reel, 3000
		SOT-23-3 (L-Type)	-40°C to +125°C	SGM818D-3.3LXN3G/TR	GXJXX	Tape and Reel, 3000
SGM818D-3.9	3.9	SOT-23-3	-40°C to +125°C	SGM818D-3.9XN3G/TR	GXVXX	Tape and Reel, 3000
		SOT-23-3 (L-Type)	-40°C to +125°C	SGM818D-3.9LXN3G/TR	GXWXX	Tape and Reel, 3000
SGM818D-4.6	4.6	SOT-23-3	-40°C to +125°C	SGM818D-4.6XN3G/TR	GYMXX	Tape and Reel, 3000
		SOT-23-3 (L-Type)	-40°C to +125°C	SGM818D-4.6LXN3G/TR	GYNXX	Tape and Reel, 3000
SGM818D-5.0	5	SOT-23-3	-40°C to +125°C	SGM818D-5.0XN3G/TR	GYVXX	Tape and Reel, 3000
		SOT-23-3 (L-Type)	-40°C to +125°C	SGM818D-5.0LXN3G/TR	GYWXX	Tape and Reel, 3000
SGM818E-1.2	1.2	SOT-23-3	-40°C to +125°C	SGM818E-1.2XN3G/TR	GYXXX	Tape and Reel, 3000
		SOT-23-3 (L-Type)	-40°C to +125°C	SGM818E-1.2LXN3G/TR	GYZXX	Tape and Reel, 3000
SGM818E-1.4	1.4	SOT-23-3	-40°C to +125°C	SGM818E-1.4XN3G/TR	GZCXX	Tape and Reel, 3000
		SOT-23-3 (L-Type)	-40°C to +125°C	SGM818E-1.4LXN3G/TR	GZDXX	Tape and Reel, 3000
SGM818E-1.6	1.6	SOT-23-3	-40°C to +125°C	SGM818E-1.6XN3G/TR	GZGXX	Tape and Reel, 3000
		SOT-23-3 (L-Type)	-40°C to +125°C	SGM818E-1.6LXN3G/TR	GZHXX	Tape and Reel, 3000
SGM818E-1.8	1.8	SOT-23-3	-40°C to +125°C	SGM818E-1.8XN3G/TR	GZKXX	Tape and Reel, 3000
		SOT-23-3 (L-Type)	-40°C to +125°C	SGM818E-1.8LXN3G/TR	GZLXX	Tape and Reel, 3000

PACKAGE/ORDERING INFORMATION (continued)

MODEL	THRESHOLD VOLTAGE (V)	PACKAGE DESCRIPTION	SPECIFIED TEMPERATURE RANGE	ORDERING NUMBER	PACKAGE MARKING	PACKING OPTION
SGM818E-2.0	2	SOT-23-3	-40°C to +125°C	SGM818E-2.0XN3G/TR	GZPXX	Tape and Reel, 3000
		SOT-23-3 (L-Type)	-40°C to +125°C	SGM818E-2.0LXN3G/TR	GZQXX	Tape and Reel, 3000
SGM818E-2.2	2.2	SOT-23-3	-40°C to +125°C	SGM818E-2.2XN3G/TR	GZTXX	Tape and Reel, 3000
		SOT-23-3 (L-Type)	-40°C to +125°C	SGM818E-2.2LXN3G/TR	GZUXX	Tape and Reel, 3000
SGM818E-2.3	2.3	SOT-23-3	-40°C to +125°C	SGM818E-2.3XN3G/TR	GZVXX	Tape and Reel, 3000
		SOT-23-3 (L-Type)	-40°C to +125°C	SGM818E-2.3LXN3G/TR	GZWXX	Tape and Reel, 3000
SGM818E-2.5	2.5	SOT-23-3	-40°C to +125°C	SGM818E-2.5XN3G/TR	GZZXX	Tape and Reel, 3000
		SOT-23-3 (L-Type)	-40°C to +125°C	SGM818E-2.5LXN3G/TR	M00XX	Tape and Reel, 3000
SGM818E-2.7	2.7	SOT-23-3	-40°C to +125°C	SGM818E-2.7XN3G/TR	M03XX	Tape and Reel, 3000
		SOT-23-3 (L-Type)	-40°C to +125°C	SGM818E-2.7LXN3G/TR	M04XX	Tape and Reel, 3000
SGM818E-2.8	2.8	SOT-23-3	-40°C to +125°C	SGM818E-2.8XN3G/TR	M05XX	Tape and Reel, 3000
		SOT-23-3 (L-Type)	-40°C to +125°C	SGM818E-2.8LXN3G/TR	M06XX	Tape and Reel, 3000
SGM818E-2.9	2.9	SOT-23-3	-40°C to +125°C	SGM818E-2.9XN3G/TR	M07XX	Tape and Reel, 3000
		SOT-23-3 (L-Type)	-40°C to +125°C	SGM818E-2.9LXN3G/TR	M0GXX	Tape and Reel, 3000
SGM818E-3.0	3	SOT-23-3	-40°C to +125°C	SGM818E-3.0XN3G/TR	M0HXX	Tape and Reel, 3000
		SOT-23-3 (L-Type)	-40°C to +125°C	SGM818E-3.0LXN3G/TR	M0IXX	Tape and Reel, 3000
SGM818E-3.3	3.3	SOT-23-3	-40°C to +125°C	SGM818E-3.3XN3G/TR	M0NXX	Tape and Reel, 3000
		SOT-23-3 (L-Type)	-40°C to +125°C	SGM818E-3.3LXN3G/TR	M0PXX	Tape and Reel, 3000
SGM818E-3.9	3.9	SOT-23-3	-40°C to +125°C	SGM818E-3.9XN3G/TR	M1GXX	Tape and Reel, 3000
		SOT-23-3 (L-Type)	-40°C to +125°C	SGM818E-3.9LXN3G/TR	M1HXX	Tape and Reel, 3000
SGM818E-4.6	4.6	SOT-23-3	-40°C to +125°C	SGM818E-4.6XN3G/TR	M1WXX	Tape and Reel, 3000
		SOT-23-3 (L-Type)	-40°C to +125°C	SGM818E-4.6LXN3G/TR	M1XXX	Tape and Reel, 3000
SGM818E-5.0	5	SOT-23-3	-40°C to +125°C	SGM818E-5.0XN3G/TR	M2KXX	Tape and Reel, 3000
		SOT-23-3 (L-Type)	-40°C to +125°C	SGM818E-5.0LXN3G/TR	M2LXX	Tape and Reel, 3000
SGM818F-1.2	1.2	SOT-23-3	-40°C to +125°C	SGM818F-1.2XN3G/TR	M2MXX	Tape and Reel, 3000
		SOT-23-3 (L-Type)	-40°C to +125°C	SGM818F-1.2LXN3G/TR	M2NXX	Tape and Reel, 3000
SGM818F-1.4	1.4	SOT-23-3	-40°C to +125°C	SGM818F-1.4XN3G/TR	M2RXX	Tape and Reel, 3000
		SOT-23-3 (L-Type)	-40°C to +125°C	SGM818F-1.4LXN3G/TR	M2SXX	Tape and Reel, 3000
SGM818F-1.6	1.6	SOT-23-3	-40°C to +125°C	SGM818F-1.6XN3G/TR	M2VXX	Tape and Reel, 3000
		SOT-23-3 (L-Type)	-40°C to +125°C	SGM818F-1.6LXN3G/TR	M2WXX	Tape and Reel, 3000
SGM818F-1.8	1.8	SOT-23-3	-40°C to +125°C	SGM818F-1.8XN3G/TR	M2ZXX	Tape and Reel, 3000
		SOT-23-3 (L-Type)	-40°C to +125°C	SGM818F-1.8LXN3G/TR	M31XX	Tape and Reel, 3000
SGM818F-2.0	2	SOT-23-3	-40°C to +125°C	SGM818F-2.0XN3G/TR	M38XX	Tape and Reel, 3000
		SOT-23-3 (L-Type)	-40°C to +125°C	SGM818F-2.0LXN3G/TR	M39XX	Tape and Reel, 3000

PACKAGE/ORDERING INFORMATION (continued)

MODEL	THRESHOLD VOLTAGE (V)	PACKAGE DESCRIPTION	SPECIFIED TEMPERATURE RANGE	ORDERING NUMBER	PACKAGE MARKING	PACKING OPTION
SGM818F-2.2	2.2	SOT-23-3	-40°C to +125°C	SGM818F-2.2XN3G/TR	M3CXX	Tape and Reel, 3000
		SOT-23-3 (L-Type)	-40°C to +125°C	SGM818F-2.2LXN3G/TR	M3DXX	Tape and Reel, 3000
SGM818F-2.3	2.3	SOT-23-3	-40°C to +125°C	SGM818F-2.3XN3G/TR	M3EXX	Tape and Reel, 3000
		SOT-23-3 (L-Type)	-40°C to +125°C	SGM818F-2.3LXN3G/TR	M3FXX	Tape and Reel, 3000
SGM818F-2.5	2.5	SOT-23-3	-40°C to +125°C	SGM818F-2.5XN3G/TR	M3IXX	Tape and Reel, 3000
		SOT-23-3 (L-Type)	-40°C to +125°C	SGM818F-2.5LXN3G/TR	M3JXX	Tape and Reel, 3000
SGM818F-2.7	2.7	SOT-23-3	-40°C to +125°C	SGM818F-2.7XN3G/TR	M3MXX	Tape and Reel, 3000
		SOT-23-3 (L-Type)	-40°C to +125°C	SGM818F-2.7LXN3G/TR	M3NXX	Tape and Reel, 3000
SGM818F-2.8	2.8	SOT-23-3	-40°C to +125°C	SGM818F-2.8XN3G/TR	M3PXX	Tape and Reel, 3000
		SOT-23-3 (L-Type)	-40°C to +125°C	SGM818F-2.8LXN3G/TR	M3QXX	Tape and Reel, 3000
SGM818F-2.9	2.9	SOT-23-3	-40°C to +125°C	SGM818F-2.9XN3G/TR	M3RXX	Tape and Reel, 3000
		SOT-23-3 (L-Type)	-40°C to +125°C	SGM818F-2.9LXN3G/TR	M3SXX	Tape and Reel, 3000
SGM818F-3.0	3	SOT-23-3	-40°C to +125°C	SGM818F-3.0XN3G/TR	M3TXX	Tape and Reel, 3000
		SOT-23-3 (L-Type)	-40°C to +125°C	SGM818F-3.0LXN3G/TR	M3UXX	Tape and Reel, 3000
SGM818F-3.3	3.3	SOT-23-3	-40°C to +125°C	SGM818F-3.3XN3G/TR	M3ZXX	Tape and Reel, 3000
		SOT-23-3 (L-Type)	-40°C to +125°C	SGM818F-3.3LXN3G/TR	M40XX	Tape and Reel, 3000
SGM818F-3.9	3.9	SOT-23-3	-40°C to +125°C	SGM818F-3.9XN3G/TR	M4HXX	Tape and Reel, 3000
		SOT-23-3 (L-Type)	-40°C to +125°C	SGM818F-3.9LXN3G/TR	M4IXX	Tape and Reel, 3000
SGM818F-4.6	4.6	SOT-23-3	-40°C to +125°C	SGM818F-4.6XN3G/TR	M4WXX	Tape and Reel, 3000
		SOT-23-3 (L-Type)	-40°C to +125°C	SGM818F-4.6LXN3G/TR	M4XXX	Tape and Reel, 3000
SGM818F-5.0	5	SOT-23-3	-40°C to +125°C	SGM818F-5.0XN3G/TR	M5KXX	Tape and Reel, 3000
		SOT-23-3 (L-Type)	-40°C to +125°C	SGM818F-5.0LXN3G/TR	M5LXX	Tape and Reel, 3000
SGM818G-1.2	1.2	SOT-23-3	-40°C to +125°C	SGM818G-1.2XN3G/TR	M5MXX	Tape and Reel, 3000
		SOT-23-3 (L-Type)	-40°C to +125°C	SGM818G-1.2LXN3G/TR	M5NXX	Tape and Reel, 3000
SGM818G-1.4	1.4	SOT-23-3	-40°C to +125°C	SGM818G-1.4XN3G/TR	M5RXX	Tape and Reel, 3000
		SOT-23-3 (L-Type)	-40°C to +125°C	SGM818G-1.4LXN3G/TR	M5SXX	Tape and Reel, 3000
SGM818G-1.6	1.6	SOT-23-3	-40°C to +125°C	SGM818G-1.6XN3G/TR	M5VXX	Tape and Reel, 3000
		SOT-23-3 (L-Type)	-40°C to +125°C	SGM818G-1.6LXN3G/TR	M5WXX	Tape and Reel, 3000
SGM818G-1.8	1.8	SOT-23-3	-40°C to +125°C	SGM818G-1.8XN3G/TR	M5ZXX	Tape and Reel, 3000
		SOT-23-3 (L-Type)	-40°C to +125°C	SGM818G-1.8LXN3G/TR	M61XX	Tape and Reel, 3000
SGM818G-2.0	2	SOT-23-3	-40°C to +125°C	SGM818G-2.0XN3G/TR	M69XX	Tape and Reel, 3000
		SOT-23-3 (L-Type)	-40°C to +125°C	SGM818G-2.0LXN3G/TR	M6AXX	Tape and Reel, 3000
SGM818G-2.2	2.2	SOT-23-3	-40°C to +125°C	SGM818G-2.2XN3G/TR	M6EXX	Tape and Reel, 3000
		SOT-23-3 (L-Type)	-40°C to +125°C	SGM818G-2.2LXN3G/TR	M6GXX	Tape and Reel, 3000

PACKAGE/ORDERING INFORMATION (continued)

MODEL	THRESHOLD VOLTAGE (V)	PACKAGE DESCRIPTION	SPECIFIED TEMPERATURE RANGE	ORDERING NUMBER	PACKAGE MARKING	PACKING OPTION
SGM818G-2.3	2.3	SOT-23-3	-40°C to +125°C	SGM818G-2.3XN3G/TR	M6HXX	Tape and Reel, 3000
		SOT-23-3 (L-Type)	-40°C to +125°C	SGM818G-2.3LXN3G/TR	M6IXX	Tape and Reel, 3000
SGM818G-2.5	2.5	SOT-23-3	-40°C to +125°C	SGM818G-2.5XN3G/TR	M6LXX	Tape and Reel, 3000
		SOT-23-3 (L-Type)	-40°C to +125°C	SGM818G-2.5LXN3G/TR	M6MXX	Tape and Reel, 3000
SGM818G-2.7	2.7	SOT-23-3	-40°C to +125°C	SGM818G-2.7XN3G/TR	M6QXX	Tape and Reel, 3000
		SOT-23-3 (L-Type)	-40°C to +125°C	SGM818G-2.7LXN3G/TR	M6RXX	Tape and Reel, 3000
SGM818G-2.8	2.8	SOT-23-3	-40°C to +125°C	SGM818G-2.8XN3G/TR	G6YXX	Tape and Reel, 3000
		SOT-23-3 (L-Type)	-40°C to +125°C	SGM818G-2.8LXN3G/TR	M6SXX	Tape and Reel, 3000
SGM818G-2.9	2.9	SOT-23-3	-40°C to +125°C	SGM818G-2.9XN3G/TR	M6TXX	Tape and Reel, 3000
		SOT-23-3 (L-Type)	-40°C to +125°C	SGM818G-2.9LXN3G/TR	M6UXX	Tape and Reel, 3000
SGM818G-3.0	3	SOT-23-3	-40°C to +125°C	SGM818G-3.0XN3G/TR	M6VXX	Tape and Reel, 3000
		SOT-23-3 (L-Type)	-40°C to +125°C	SGM818G-3.0LXN3G/TR	M6WXX	Tape and Reel, 3000
SGM818G-3.3	3.3	SOT-23-3	-40°C to +125°C	SGM818G-3.3XN3G/TR	M7HXX	Tape and Reel, 3000
		SOT-23-3 (L-Type)	-40°C to +125°C	SGM818G-3.3LXN3G/TR	M7IXX	Tape and Reel, 3000
SGM818G-3.9	3.9	SOT-23-3	-40°C to +125°C	SGM818G-3.9XN3G/TR	M7UXX	Tape and Reel, 3000
		SOT-23-3 (L-Type)	-40°C to +125°C	SGM818G-3.9LXN3G/TR	M7VXX	Tape and Reel, 3000
SGM818G-4.6	4.6	SOT-23-3	-40°C to +125°C	SGM818G-4.6XN3G/TR	M8PXX	Tape and Reel, 3000
		SOT-23-3 (L-Type)	-40°C to +125°C	SGM818G-4.6LXN3G/TR	M8QXX	Tape and Reel, 3000
SGM818G-5.0	5	SOT-23-3	-40°C to +125°C	SGM818G-5.0XN3G/TR	M8XXX	Tape and Reel, 3000
		SOT-23-3 (L-Type)	-40°C to +125°C	SGM818G-5.0LXN3G/TR	M8YXX	Tape and Reel, 3000
SGM818H-1.2	1.2	SOT-23-3	-40°C to +125°C	SGM818H-1.2XN3G/TR	M8ZXX	Tape and Reel, 3000
		SOT-23-3 (L-Type)	-40°C to +125°C	SGM818H-1.2LXN3G/TR	M92XX	Tape and Reel, 3000
SGM818H-1.4	1.4	SOT-23-3	-40°C to +125°C	SGM818H-1.4XN3G/TR	M9GXX	Tape and Reel, 3000
		SOT-23-3 (L-Type)	-40°C to +125°C	SGM818H-1.4LXN3G/TR	M9HXX	Tape and Reel, 3000
SGM818H-1.6	1.6	SOT-23-3	-40°C to +125°C	SGM818H-1.6XN3G/TR	M9KXX	Tape and Reel, 3000
		SOT-23-3 (L-Type)	-40°C to +125°C	SGM818H-1.6LXN3G/TR	M9LXX	Tape and Reel, 3000
SGM818H-1.8	1.8	SOT-23-3	-40°C to +125°C	SGM818H-1.8XN3G/TR	M9PXX	Tape and Reel, 3000
		SOT-23-3 (L-Type)	-40°C to +125°C	SGM818H-1.8LXN3G/TR	M9QXX	Tape and Reel, 3000
SGM818H-2.0	2	SOT-23-3	-40°C to +125°C	SGM818H-2.0XN3G/TR	M9TXX	Tape and Reel, 3000
		SOT-23-3 (L-Type)	-40°C to +125°C	SGM818H-2.0LXN3G/TR	M9UXX	Tape and Reel, 3000
SGM818H-2.2	2.2	SOT-23-3	-40°C to +125°C	SGM818H-2.2XN3G/TR	M9XXX	Tape and Reel, 3000
		SOT-23-3 (L-Type)	-40°C to +125°C	SGM818H-2.2LXN3G/TR	M9YXX	Tape and Reel, 3000
SGM818H-2.3	2.3	SOT-23-3	-40°C to +125°C	SGM818H-2.3XN3G/TR	M9ZXX	Tape and Reel, 3000
		SOT-23-3 (L-Type)	-40°C to +125°C	SGM818H-2.3LXN3G/TR	MA0XX	Tape and Reel, 3000

ABSOLUTE MAXIMUM RATINGS

Terminal Voltage (with Respect to GND), V_{DD}	-0.3V to 6V
All Other Inputs	-0.3V to 6V
Input Current, I_{VDD}	20mA
Package Thermal Resistance	
SOT-23-3, θ_{JA}	255.2°C/W
SOT-23-3, θ_{JB}	111.9°C/W
SOT-23-3, θ_{JC}	147.7°C/W
Junction Temperature	+150°C
Storage Temperature Range	-65°C to +150°C
Lead Temperature (Soldering, 10s)	+260°C
ESD Susceptibility	
HBM	±4000V
CDM	±400V

RECOMMENDED OPERATING CONDITIONS

Operating Junction Temperature Range..... -40°C to +125°C

OVERSTRESS CAUTION

Stresses beyond those listed in Absolute Maximum Ratings may cause permanent damage to the device. Exposure to absolute maximum rating conditions for extended periods may affect reliability. Functional operation of the device at any conditions beyond those indicated in the Recommended Operating Conditions section is not implied.

ESD SENSITIVITY CAUTION

This integrated circuit can be damaged if ESD protections are not considered carefully. SGMICRO recommends that all integrated circuits be handled with appropriate precautions. Failure to observe proper handling and installation procedures can cause damage. ESD damage can range from subtle performance degradation to complete device failure. Precision integrated circuits may be more susceptible to damage because even small parametric changes could cause the device not to meet the published specifications.

DISCLAIMER

SG Micro Corp reserves the right to make any change in circuit design, or specifications without prior notice.

PIN CONFIGURATIONS

SGM818A/SGM818B/SGM818C/SGM818D

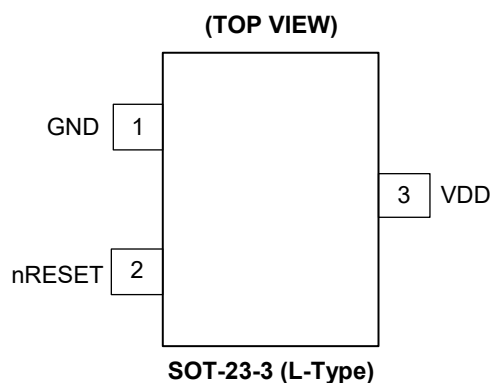
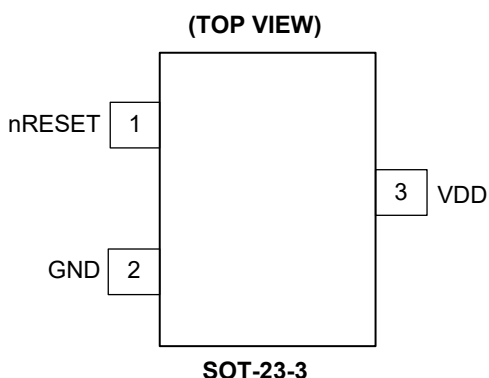

SGM818E/SGM818F/SGM818G/SGM818H

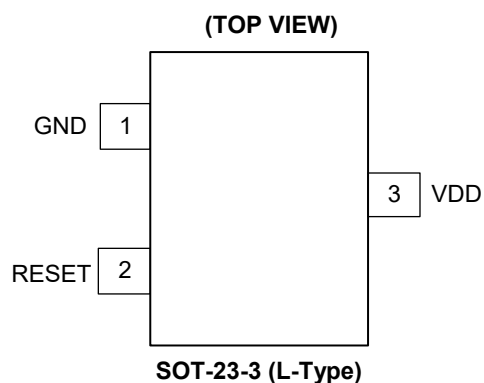
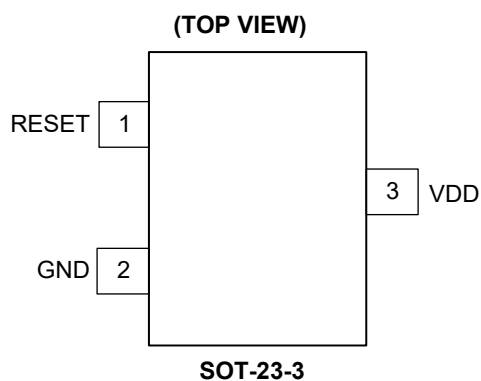

PIN DESCRIPTION

PIN		NAME	FUNCTION
SOT-23-3	SOT-23-3 (L-Type)		
2	1	GND	Ground.
1	2	nRESET	Active-Low Reset Output Pin. (Version A, B, C, D)
		RESET	Active-High Reset Output. (Version E, F, G, H)
3	3	VDD	Power Pin.

ELECTRICAL CHARACTERISTICS

(V_{DD} = 3V, T_J = +25°C, unless otherwise noted.)

PARAMETER	SYMBOL	CONDITIONS	MIN	TYP	MAX	UNITS
Operating V _{DD} (V _{OUT}) Range	V _{DD}		0.9		6	V
Supply Current	I _{DD}	V _{TH} = 3V, V _{DD} = 4.5V, T _J = +25°C		1	2	μA
Reset Threshold	V _{TH}			1.2 to 5		V
Threshold Voltage Accuracy	ΔV _{TH}	T _J = +25°C	-1		1	%
V _{DD} Drop to Reset Delay	t _{RD}	Drop = V _{TH} - 125mV		37		μs
Reset Active Timeout Period	SGM818A/E	V _{DD} ≥ 1.02 × V _{TH}		0.8		ms
	SGM818B/F		34	51	70	
	SGM818C/G		146	208	274	
	SGM818D/H		268	409	543	
RESET Output Voltage Low ⁽¹⁾	V _{OL}	1.5V = V _{DD} < V _{TH} , I _{ISINK} = 3.5mA			0.4	V
Hysteresis Width	V _{HYS}			0.64% × V _{TH}	1.6% × V _{TH}	V

NOTE:

1. V_{OL} can be calculated by V_{OL} = V_{DD} - I_R × R_{PU}, where R_{PU} is the pull-up resistor and I_R is the current flowing through the pull-up resistor. For typical application, R_{PU} is 100kΩ and V_{OL} is less than 0.2V.

TIMING DIAGRAM

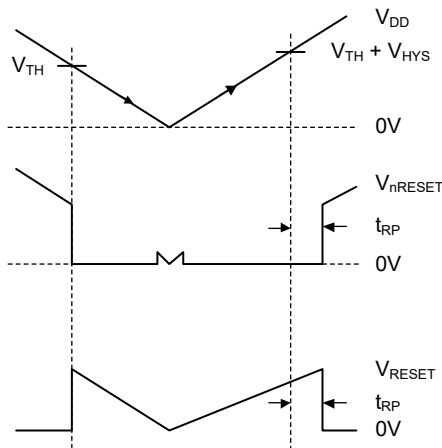
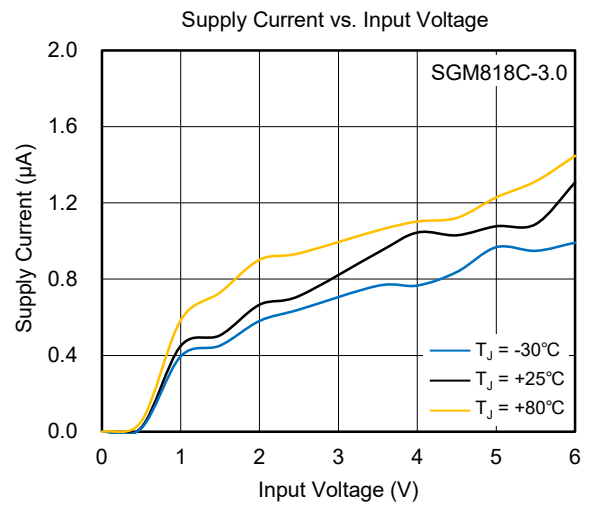
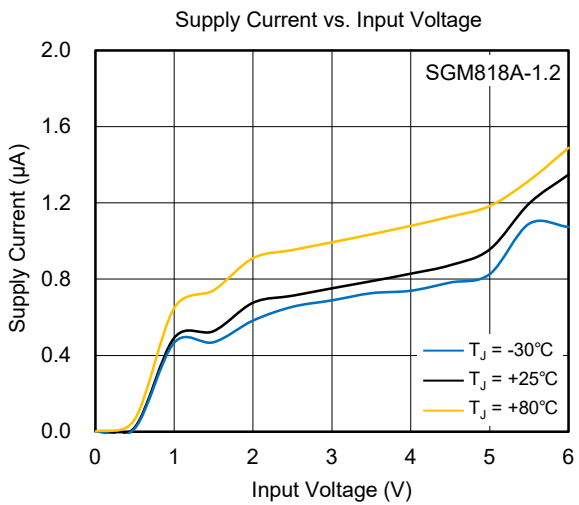
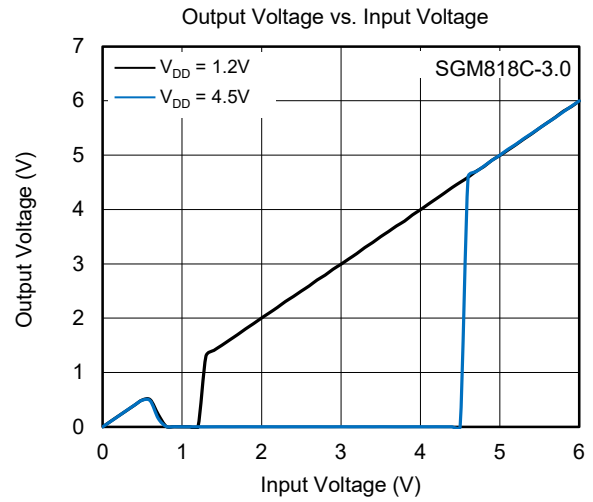
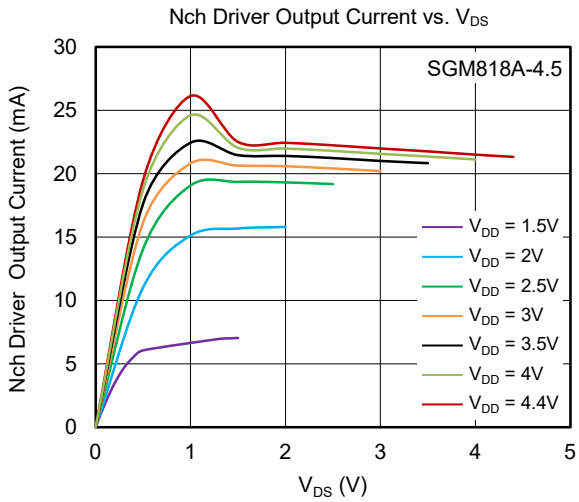
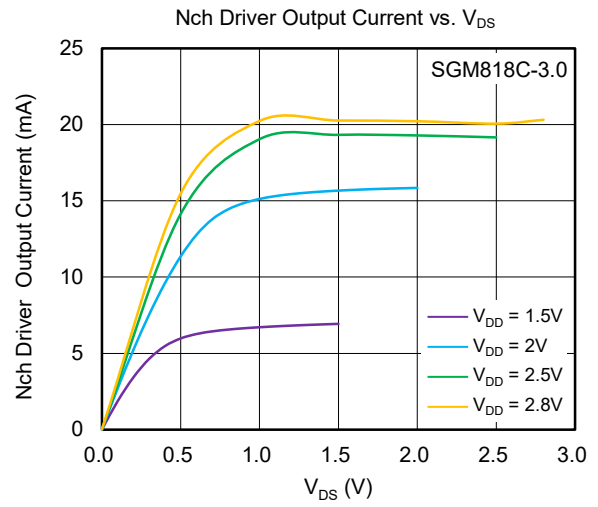
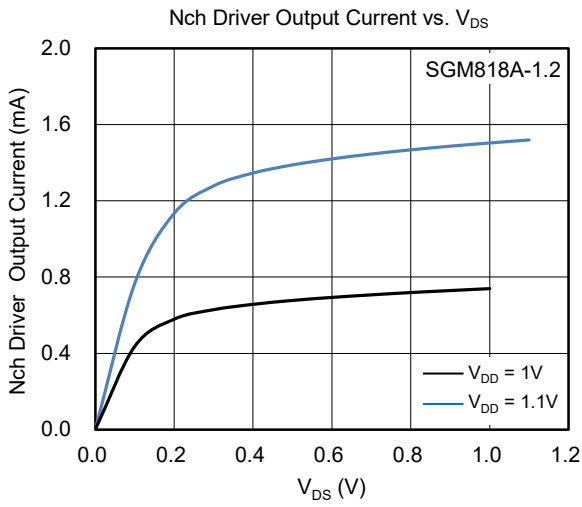
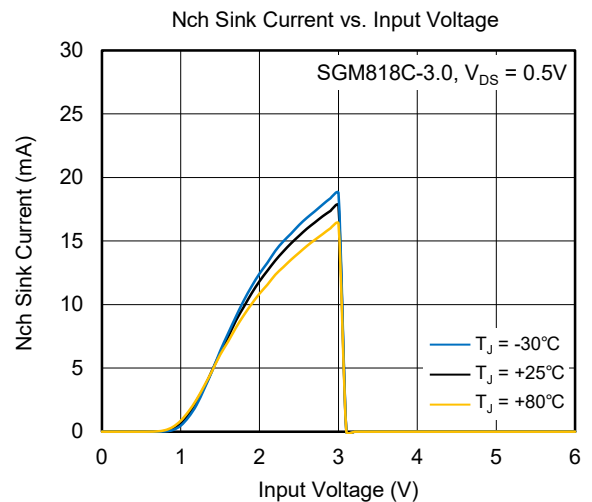
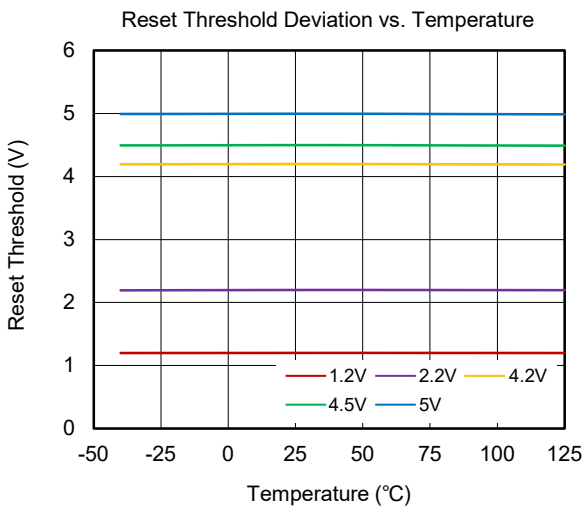
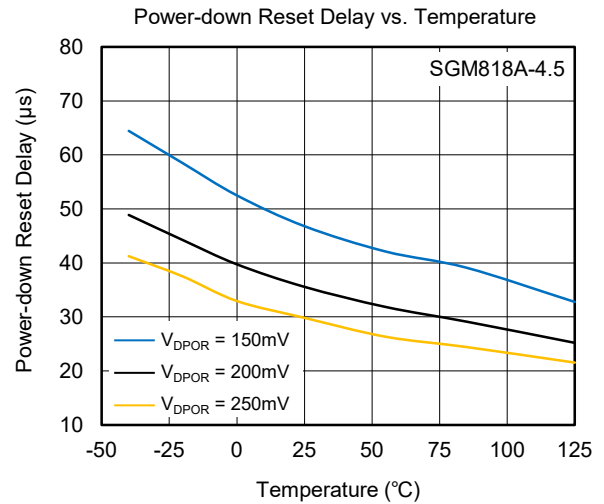
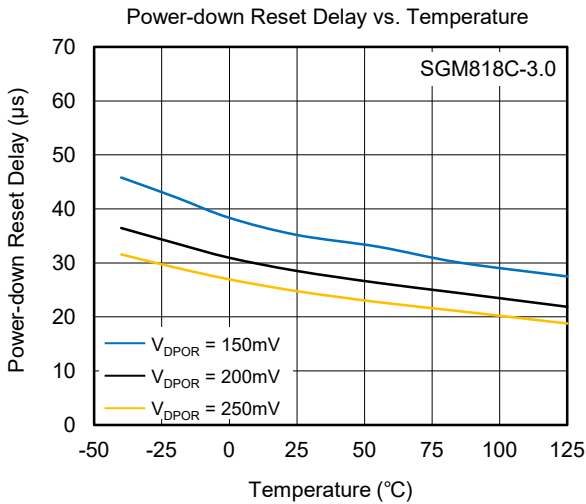
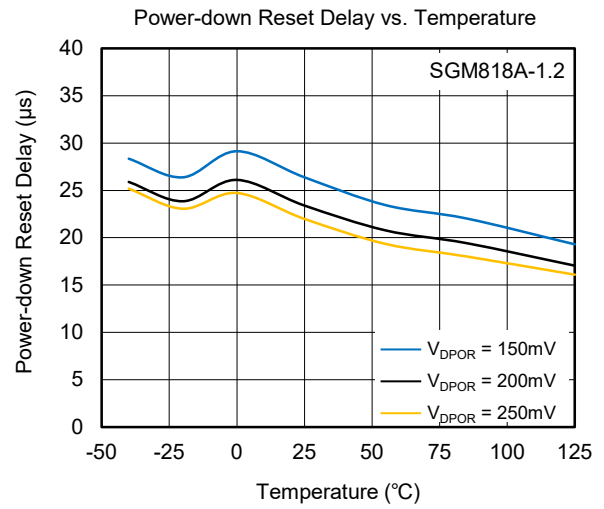
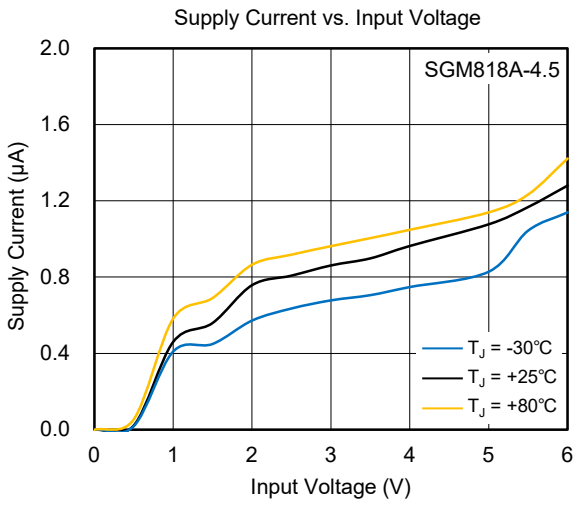

Figure 2. Timing Diagram

TYPICAL PERFORMANCE CHARACTERISTICS



TYPICAL PERFORMANCE CHARACTERISTICS (continued)



TYPICAL PERFORMANCE CHARACTERISTICS (continued)

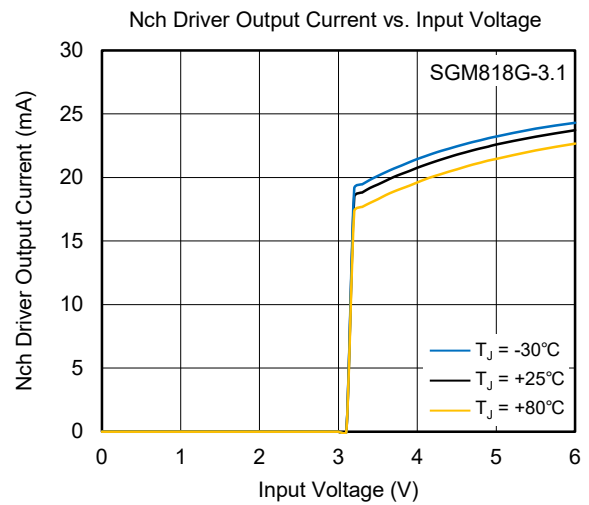
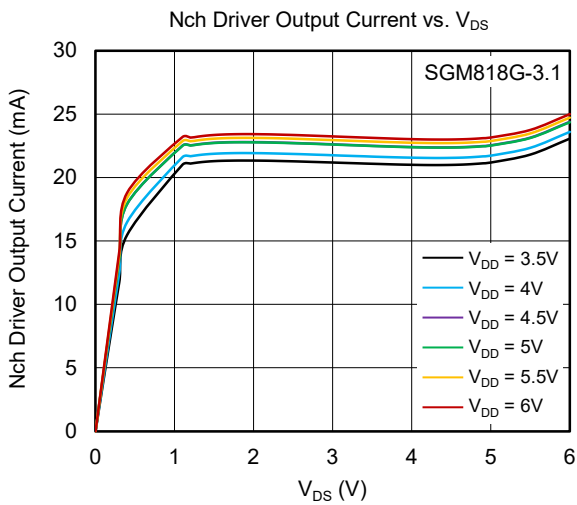
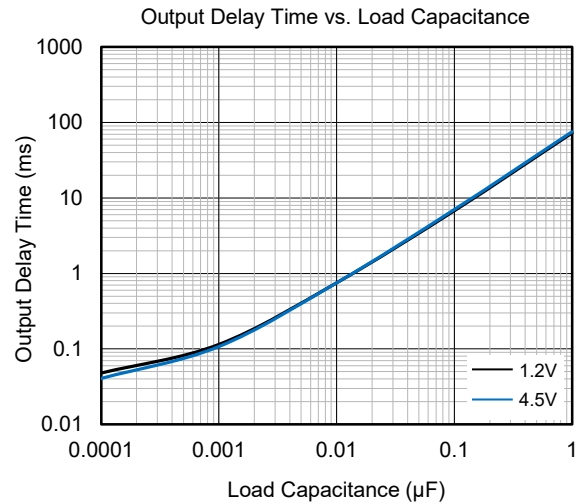
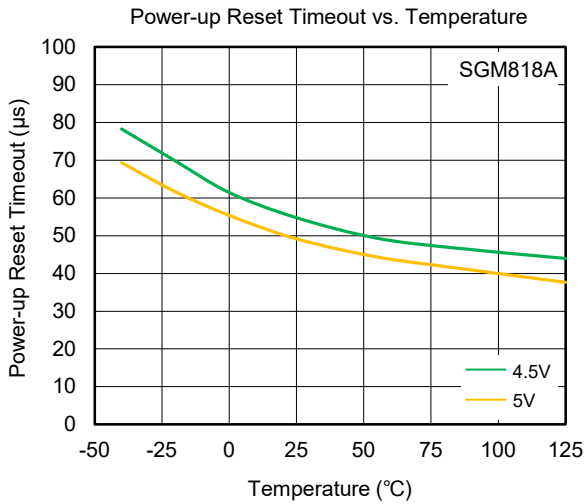
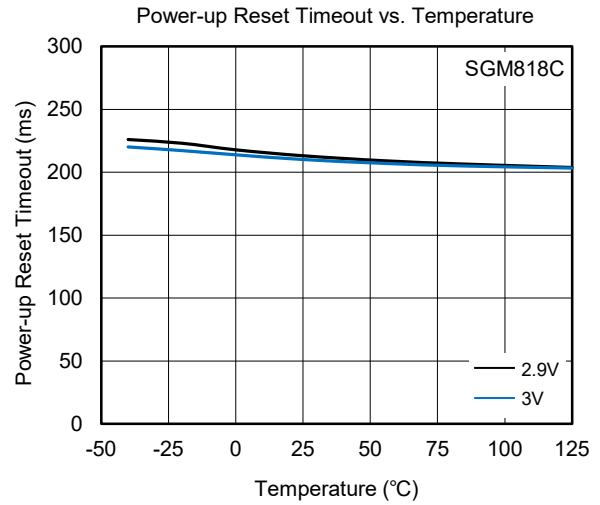
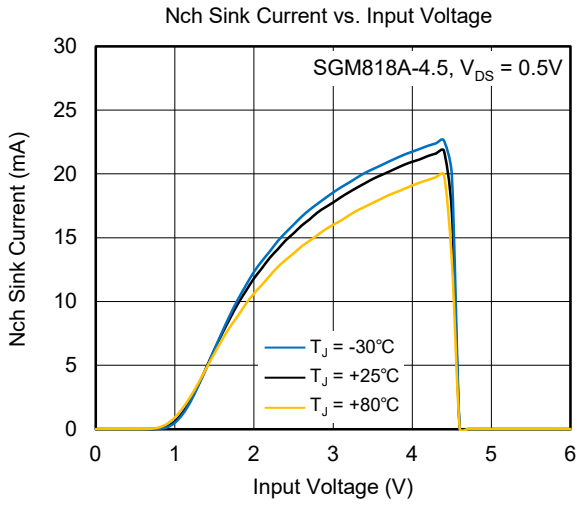

TYPICAL PERFORMANCE CHARACTERISTICS (continued)

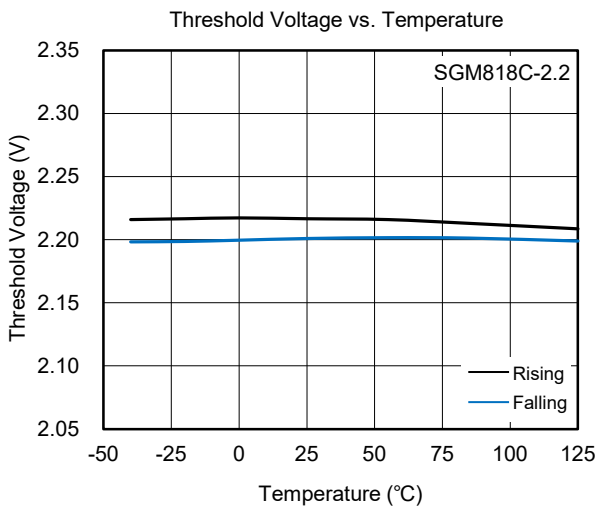
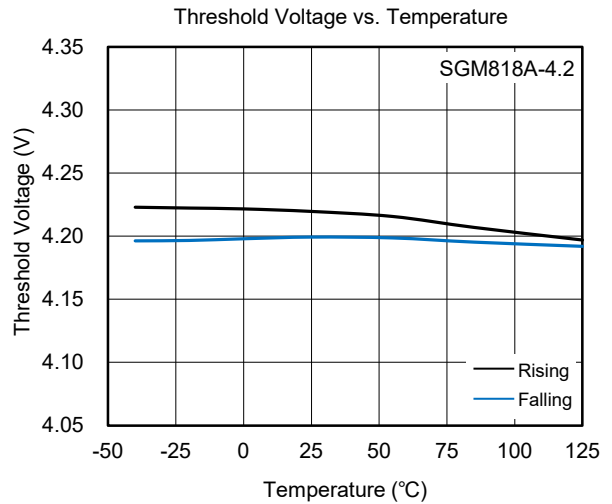
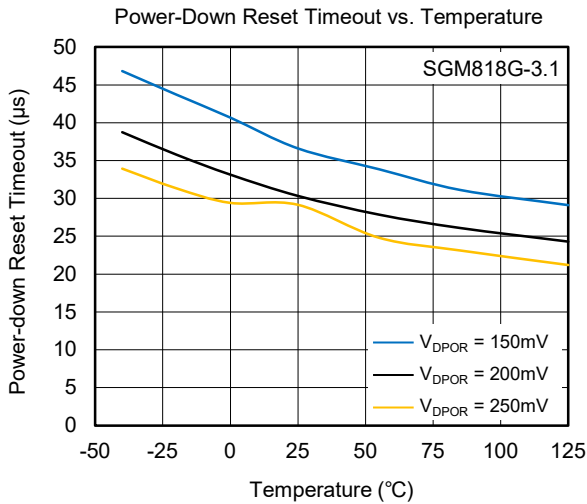
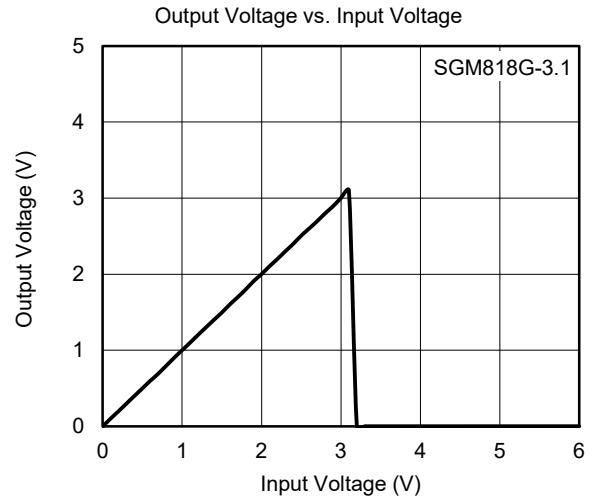
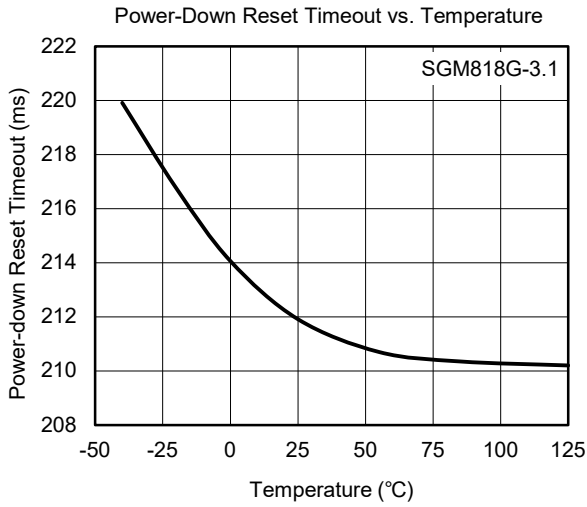

FUNCTIONAL BLOCK DIAGRAM

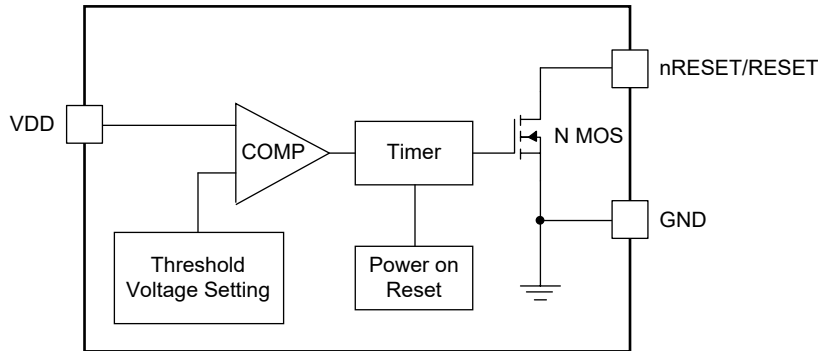

Figure 3. Block Diagram

APPLICATION INFORMATION

Multiple Supplies

The pull-up resistor connected to the SGM818 will connect to the supply voltage monitored on the VDD pin of the IC. However, the systems using open-drain output can level-shift the monitored supply voltages into the reset circuit powered by some other supply.

High Accuracy of the Reset Threshold

The reset threshold voltages of most μ P supervisor ICs are 1% to 1.5% lower than the nominal supply voltages. If the voltage is within 1% of the nominal supply, the reset will not assert, and if the voltage is within 1.5% of the nominal supply, the reset will assert.

REVISION HISTORY

NOTE: Page numbers for previous revisions may differ from page numbers in the current version.

MARCH 2026 – REV.A.2 to REV.A.3	Page
Updated Absolute Maximum Ratings section.....	10
SEPTEMBER 2024 – REV.A.1 to REV.A.2	Page
Updated Package/Ordering Information section.....	2 ~ 9
JULY 2023 – REV.A to REV.A.1	Page
Changed Electrical Characteristics section	23
Changes from Original to REV.A (MAY 2022)	Page
Changed from product preview to production data.....	All

PACKAGE OUTLINE DIMENSIONS

SOT-23-3

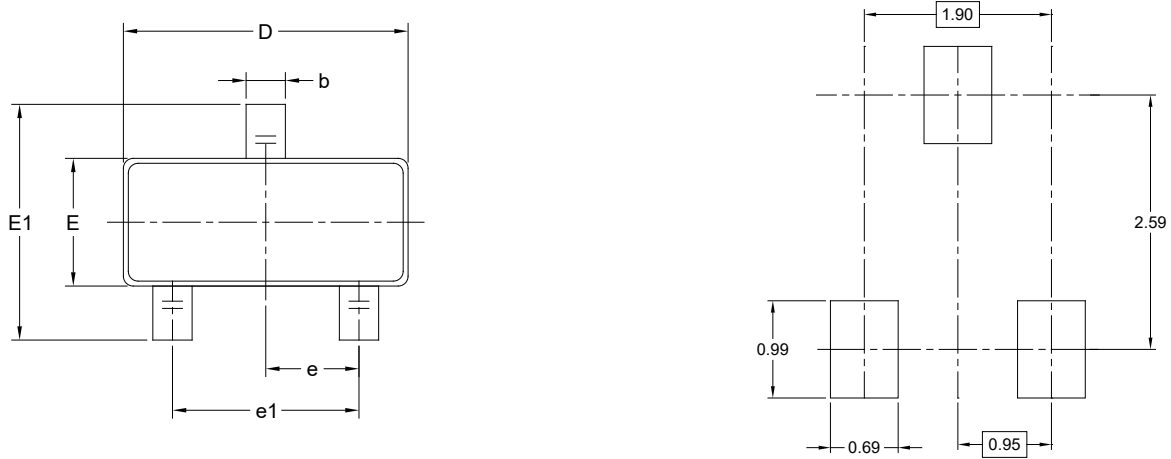

RECOMMENDED LAND PATTERN (Unit: mm)

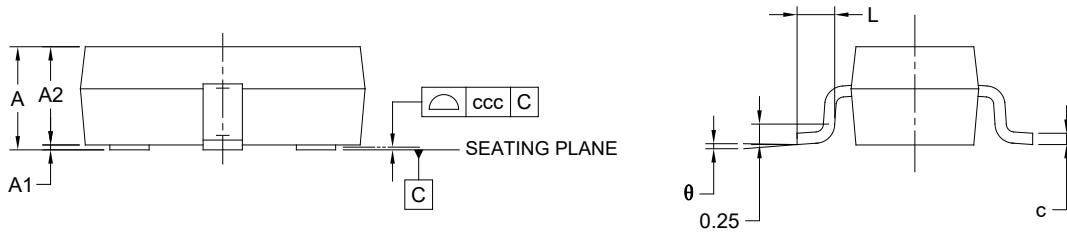

Symbol	Dimensions In Millimeters		
	MIN	MOD	MAX
A	-	-	1.450
A1	0.000	-	0.150
A2	0.900	-	1.300
b	0.300	-	0.500
c	0.080	-	0.220
D	2.750	-	3.050
E	1.450	-	1.750
E1	2.600	-	3.000
e	0.950 BSC		
e1	1.900 BSC		
L	0.300	-	0.600
θ	0°	-	8°
ccc	0.100		

NOTES:

1. This drawing is subject to change without notice.
2. The dimensions do not include mold flashes, protrusions or gate burrs.
3. Reference JEDEC MO-178.

PACKAGE INFORMATION

TAPE AND REEL INFORMATION

REEL DIMENSIONS

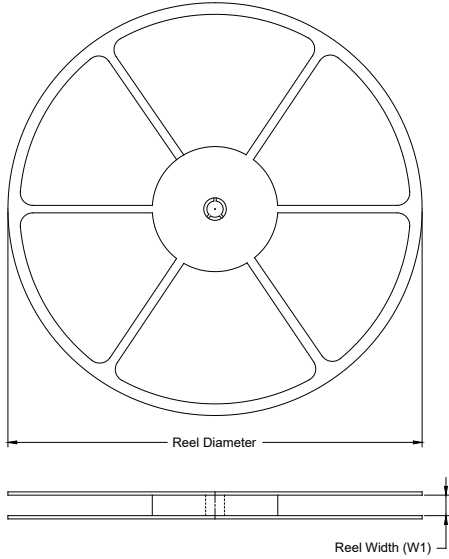

TAPE DIMENSIONS

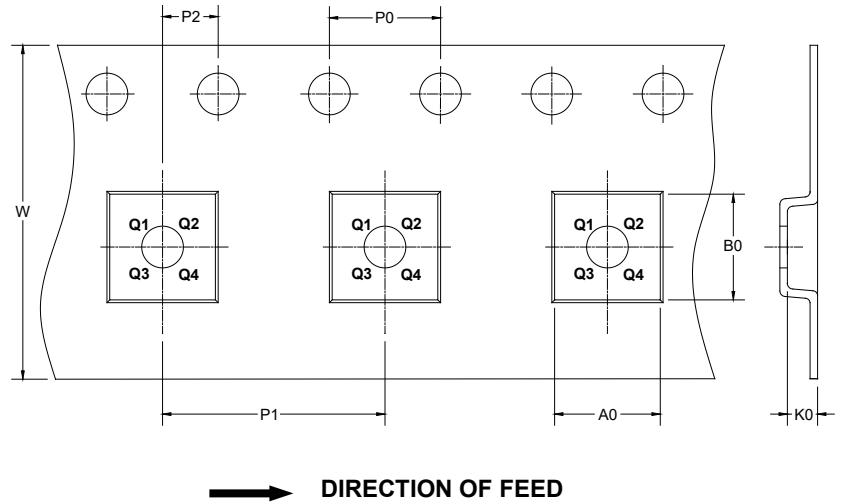

NOTE: The picture is only for reference. Please make the object as the standard.

KEY PARAMETER LIST OF TAPE AND REEL

Package Type	Reel Diameter	Reel Width W1 (mm)	A0 (mm)	B0 (mm)	K0 (mm)	P0 (mm)	P1 (mm)	P2 (mm)	W (mm)	Pin1 Quadrant
SOT-23-3	7"	9.0	3.20	3.30	1.30	4.0	4.0	2.0	8.0	Q3

000001

PACKAGE INFORMATION

CARTON BOX DIMENSIONS

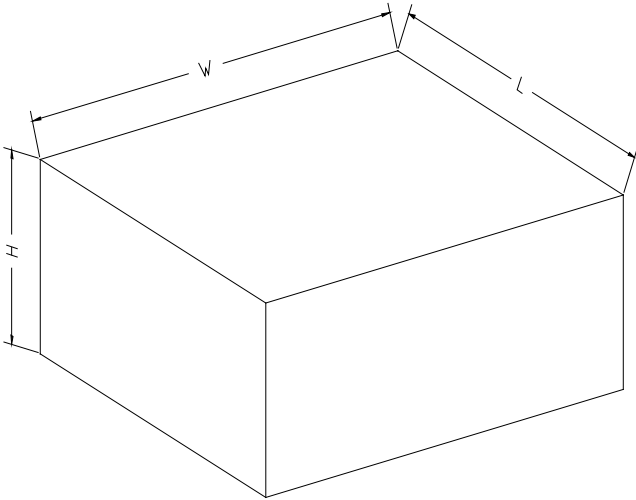

NOTE: The picture is only for reference. Please make the object as the standard.

KEY PARAMETER LIST OF CARTON BOX

Reel Type	Length (mm)	Width (mm)	Height (mm)	Pizza/Carton
7" (Option)	368	227	224	8
7"	442	410	224	18

DD0002