

GENERAL DESCRIPTION

The SGM2203 is a high voltage and low power consumption linear regulator. It is capable of supplying 150mA output current. The operating input voltage is up to 36V. The output voltage tolerance is kept within ±1%. The output voltages are 3.0V, 3.3V, 3.5V, 4.2V and 5.0V in fixed output version.

Other features include current limit and thermal shutdown protection.

The SGM2203 is available in Green SOT-23, SOT-23-5 and SOT-89-3 packages. It operates over an ambient temperature range of -40°C to +85°C.

FEATURES

- **High Input Voltage: Up to 36V**
- **Fixed Outputs of 3.0V, 3.3V, 3.5V, 4.2V and 5.0V**
- **150mA Output Current**
- **Output Voltage Accuracy: ±1% at +25°C**
- **Low Dropout Voltage**
- **Low Power Consumption: 4.2µA (TYP)**
- **Low Temperature Coefficient**
- **Current Limiting and Thermal Protection**
- **-40°C to +85°C Operating Temperature Range**
- **Available in Green SOT-23, SOT-23-5 and SOT-89-3 Packages**

APPLICATIONS

- Palmtops
- High-Power Boost Applications
- Power Source for Battery-Powered Equipment
- Home Electric/Electronic Appliances

TYPICAL APPLICATION

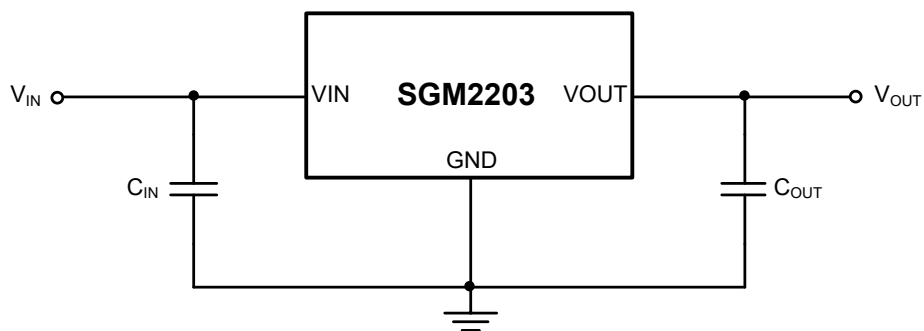

Figure 1. Typical Application Circuit

PACKAGE/ORDERING INFORMATION

MODEL	V _{OUT} (V)	PACKAGE DESCRIPTION	ORDERING NUMBER	PACKAGE MARKING	PACKING OPTION
SGM2203-3.0	3.0	SOT-23	SGM2203-3.0AYN3LG/TR	GG1XX	Tape and Reel, 3000
SGM2203-3.3	3.3	SOT-23	SGM2203-3.3AYN3LG/TR	GG2XX	Tape and Reel, 3000
SGM2203-5.0	5.0	SOT-23	SGM2203-5.0AYN3LG/TR	GG3XX	Tape and Reel, 3000
SGM2203-3.0	3.0	SOT-23-5	SGM2203-3.0AYN5G/TR	GH6XX	Tape and Reel, 3000
SGM2203-3.3	3.3	SOT-23-5	SGM2203-3.3AYN5G/TR	GH9XX	Tape and Reel, 3000
SGM2203-5.0	5.0	SOT-23-5	SGM2203-5.0AYN5G/TR	GH4XX	Tape and Reel, 3000
SGM2203-4.2	4.2	SOT-23-5 (L-Type)	SGM2203-4.2AYN5LG/TR	GN8XX	Tape and Reel, 3000
SGM2203-3.0	3.0	SOT-89-3 (L-Type)	SGM2203-3.0AYK3LG/TR	GG4XX	Tape and Reel, 1000
SGM2203-3.3	3.3	SOT-89-3 (L-Type)	SGM2203-3.3AYK3LG/TR	GG5XX	Tape and Reel, 1000
SGM2203-3.5	3.5	SOT-89-3 (L-Type)	SGM2203-3.5AYK3LG/TR	M08XX	Tape and Reel, 1000
SGM2203-5.0	5.0	SOT-89-3 (L-Type)	SGM2203-5.0AYK3LG/TR	GG6XX	Tape and Reel, 1000

MARKING INFORMATION

NOTE: XX = Date Code.

YYY X X

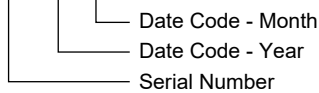

Green (RoHS & HSF): SG Micro Corp defines "Green" to mean Pb-Free (RoHS compatible) and free of halogen substances. If you have additional comments or questions, please contact your SGMICRO representative directly.

ABSOLUTE MAXIMUM RATINGS

VIN to GND	-0.3V to 44V
VOUT to GND	-0.3V to MIN(VIN + 0.3V, 6V)
Power Dissipation, PD @ TA = +25°C	
SOT-23	0.49W
SOT-23-5	0.61W
SOT-23-5 (L-Type).....	0.71W
SOT-89-3 (L-Type).....	1.13W
Package Thermal Resistance	
SOT-23, θJA.....	252.4°C/W
SOT-23, θJB.....	92.9°C/W
SOT-23, θJC	142.4°C/W
SOT-23-5, θJA	204.8°C/W
SOT-23-5, θJB	87.5°C/W
SOT-23-5, θJC	134.1°C/W
SOT-23-5 (L-Type), θJA	175.3°C/W
SOT-23-5 (L-Type), θJB	55.8°C/W
SOT-23-5 (L-Type), θJC.....	100.9°C/W
SOT-89-3 (L-Type), θJA	110°C/W
SOT-89-3 (L-Type), θJB	64.3°C/W
SOT-89-3 (L-Type), θJC.....	131.1°C/W
Junction Temperature	+150°C
Storage Temperature Range.....	-65°C to +150°C
Lead Temperature (Soldering, 10s)	+260°C
ESD Susceptibility	
HBM.....	4000V
MM.....	200V
CDM	1000V

RECOMMENDED OPERATING CONDITIONS

Input Voltage Range.....	2.7V to 36V
Operating Temperature Range.....	-40°C to +85°C

OVERSTRESS CAUTION

Stresses beyond those listed in Absolute Maximum Ratings may cause permanent damage to the device. Exposure to absolute maximum rating conditions for extended periods may affect reliability. Functional operation of the device at any conditions beyond those indicated in the Recommended Operating Conditions section is not implied.

ESD SENSITIVITY CAUTION

This integrated circuit can be damaged if ESD protections are not considered carefully. SGMICRO recommends that all integrated circuits be handled with appropriate precautions. Failure to observe proper handling and installation procedures can cause damage. ESD damage can range from subtle performance degradation to complete device failure. Precision integrated circuits may be more susceptible to damage because even small parametric changes could cause the device not to meet the published specifications.

DISCLAIMER

SG Micro Corp reserves the right to make any change in circuit design, or specifications without prior notice.

PIN CONFIGURATIONS

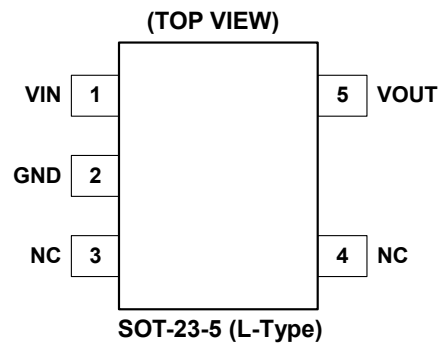
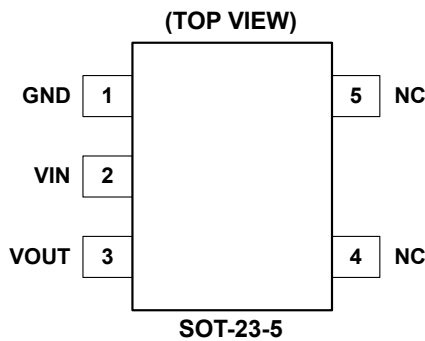
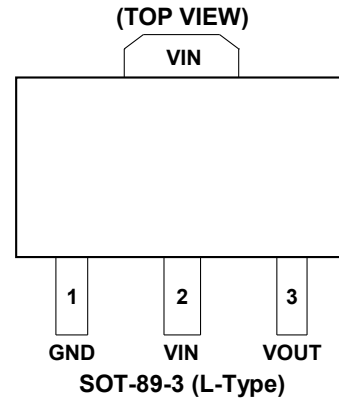
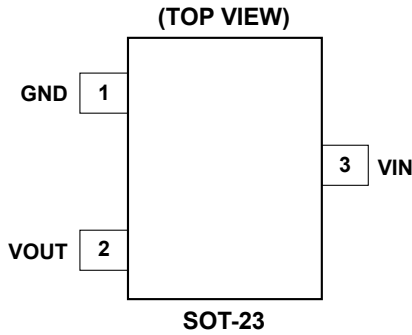

PIN DESCRIPTION

PIN				NAME	FUNCTION
SOT-23	SOT-23-5	SOT-23-5 (L-Type)	SOT-89-3 (L-Type)		
1	1	2	1	GND	Ground.
2	3	5	3	VOUT	Regulator Output Pin. It is recommended to use an output capacitor with effective capacitance in the range of 1µF to 10µF to ensure stability. The capacitor should be located very close to this pin.
3	2	1	2	VIN	Regulator Input Pin. Up to 36V input voltage. It is recommended to use a 1µF or larger ceramic capacitor from VIN pin to ground to get good power supply decoupling. This ceramic capacitor should be placed as close as possible to VIN pin.
-	4, 5	3, 4	-	NC	No Connection.

ELECTRICAL CHARACTERISTICS(V_{IN} = V_{OUT} + 2V, C_{IN} = C_{OUT} = 1μF. Full = -40°C to +85°C, typical values are at T_A = +25°C, unless otherwise noted.)

PARAMETER	SYMBOL	CONDITIONS	TEMP	MIN	TYP	MAX	UNITS	
Input Voltage Range	V _{IN}	V _{OUT} < 3.3V	Full	2.7		32	V	
		V _{OUT} ≥ 3.3V	Full	2.7		36		
Output Voltage Accuracy	V _{OUT}	I _{OUT} = 1mA	+25°C	-1		1	%	
Ground Pin Current	I _{GND}	No load	+25°C		4.2	5.5	μA	
			Full			6.5		
		I _{OUT} = 50mA	+25°C		4.2			
Maximum Output Current	I _{OUT}		+25°C	150			mA	
Dropout Voltage ⁽¹⁾	V _{DROP}	I _{OUT} = 150mA	+25°C		1300	1850	mV	
			Full			2400		
Line Regulation	$\frac{\Delta V_{OUT}}{\Delta V_{IN} \times V_{OUT}}$	V _{IN} = V _{OUT} + 2V to 32V, I _{OUT} = 1mA	V _{OUT} < 3.3V	+25°C		0.005	0.012	%V
		V _{IN} = V _{OUT} + 2V to 36V, I _{OUT} = 1mA	V _{OUT} ≥ 3.3V	+25°C		0.005	0.012	
Load Regulation	ΔV _{OUT}	I _{OUT} = 1mA to 150mA	+25°C		10	25	mV	
Power Supply Rejection Ratio	PSRR	V _{OUT} = 3.3V, I _{OUT} = 10mA	f = 217Hz	+25°C		55	dB	
			f = 1kHz	+25°C		40		
Output Voltage Temperature Coefficient	$\frac{\Delta V_{OUT}}{\Delta T_A \times V_{OUT}}$	I _{OUT} = 1mA	Full		68		ppm/°C	
Thermal Protection								
Thermal Shutdown Temperature	T _{SHDN}				150		°C	
Thermal Shutdown Hysteresis	ΔT _{SHDN}				20		°C	

NOTE:

1. The dropout voltage is defined as V_{IN} - V_{OUT}, when V_{OUT} is 95% of the value of V_{OUT} for V_{IN} = V_{OUT} + 2V.

TYPICAL PERFORMANCE CHARACTERISTICS

$T_A = +25^\circ\text{C}$, $V_{IN} = 5.3\text{V}$, $V_{OUT} = 3.3\text{V}$, $C_{IN} = C_{OUT} = 1\mu\text{F}$, unless otherwise noted.

Load-Transient Response

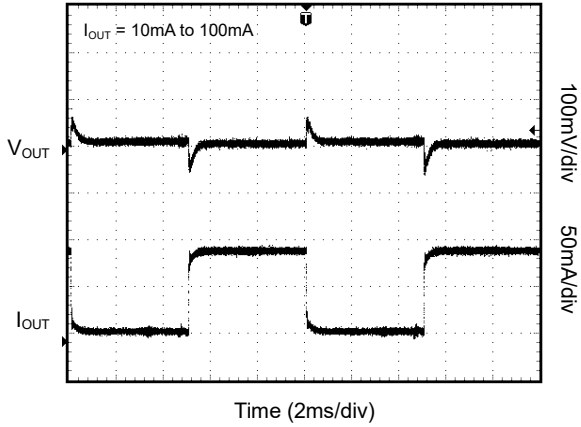

Line-Transient Response

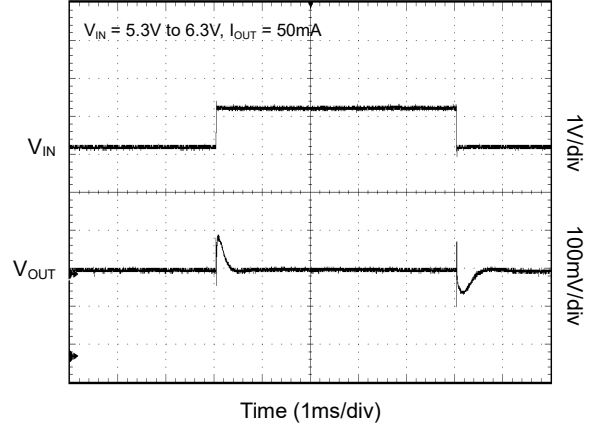

Power-Up/Power-Down Output Waveform

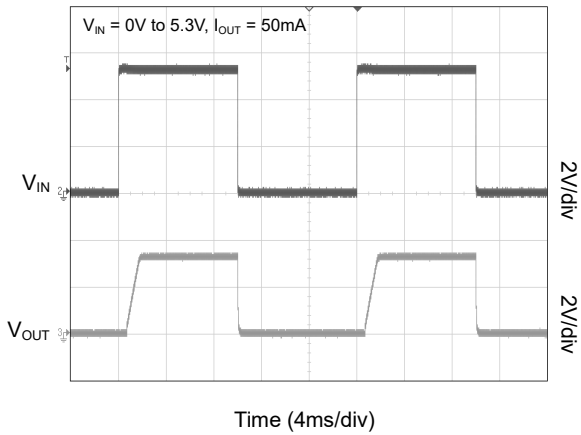

Power Ramp-Up/Ramp-Down Output Waveform

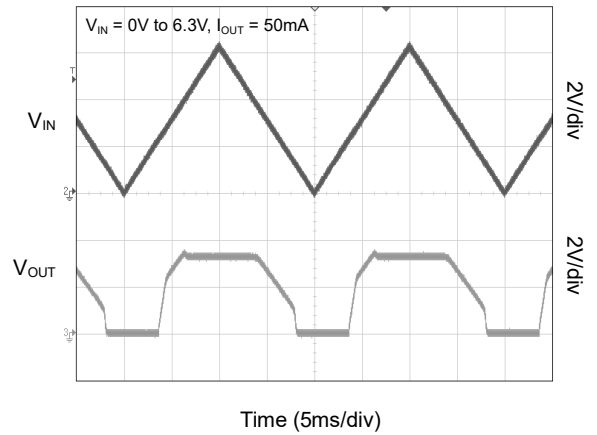

Output Short Waveform

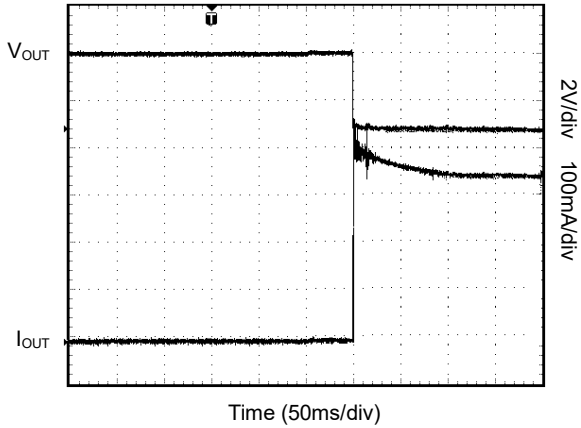

Thermal Protection Waveform

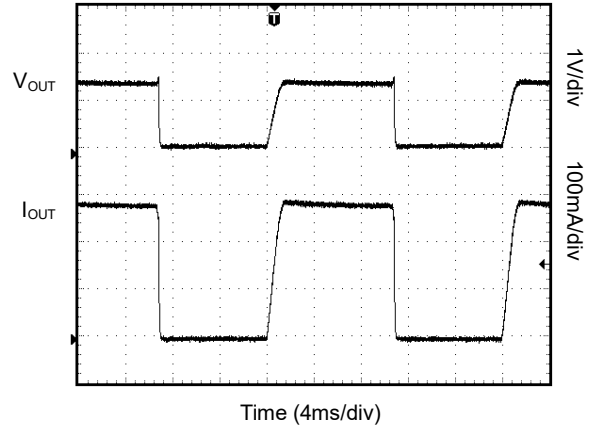

TYPICAL PERFORMANCE CHARACTERISTICS (continued)

$T_A = +25^\circ\text{C}$, $V_{IN} = 5.3\text{V}$, $V_{OUT} = 3.3\text{V}$, $C_{IN} = C_{OUT} = 1\mu\text{F}$, unless otherwise noted.

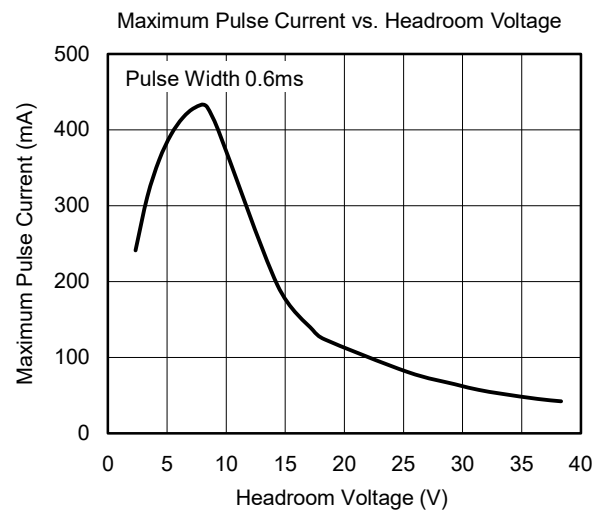
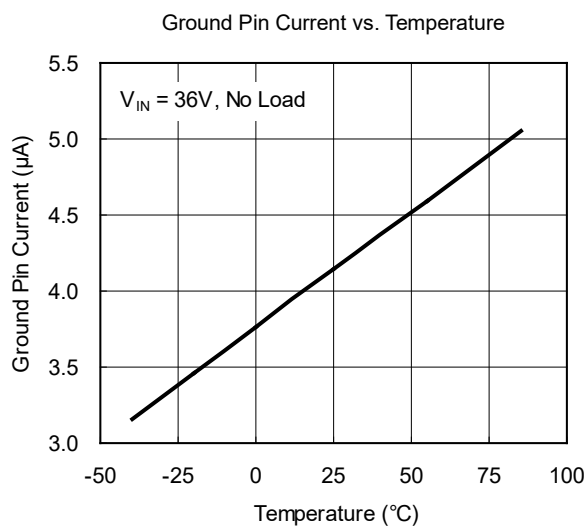
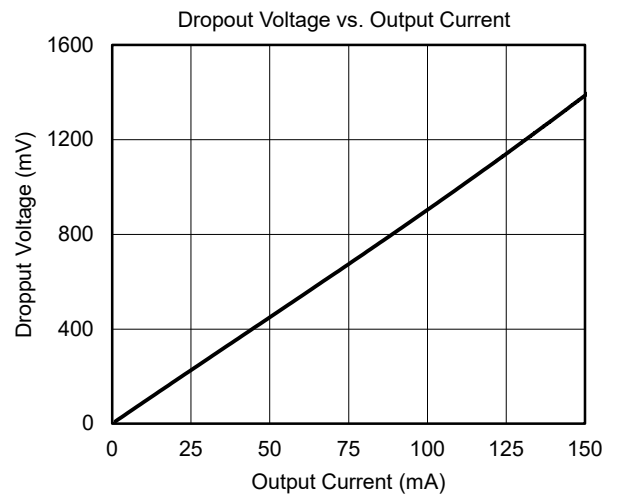
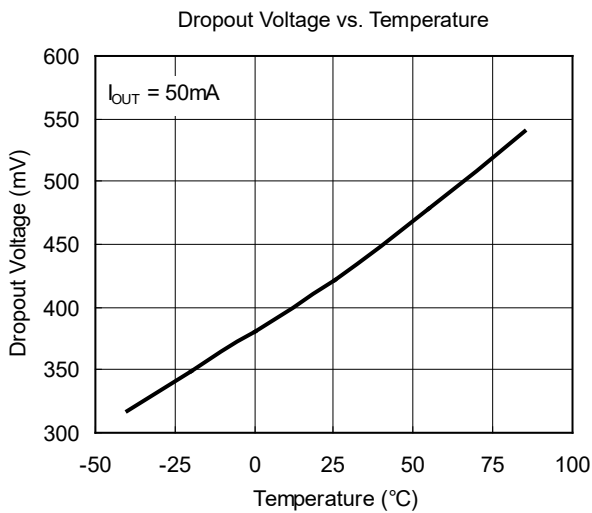
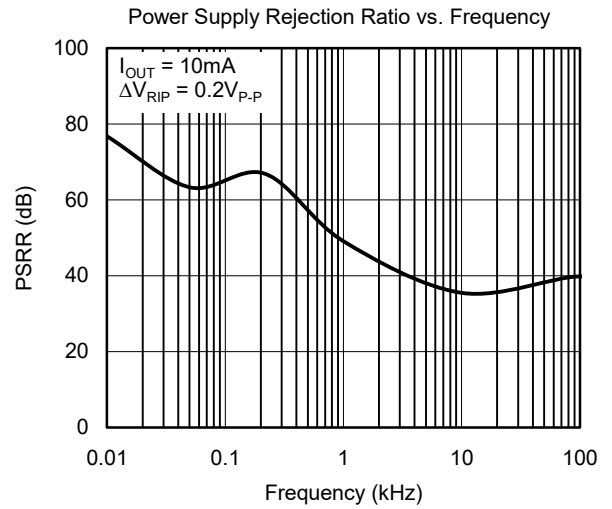
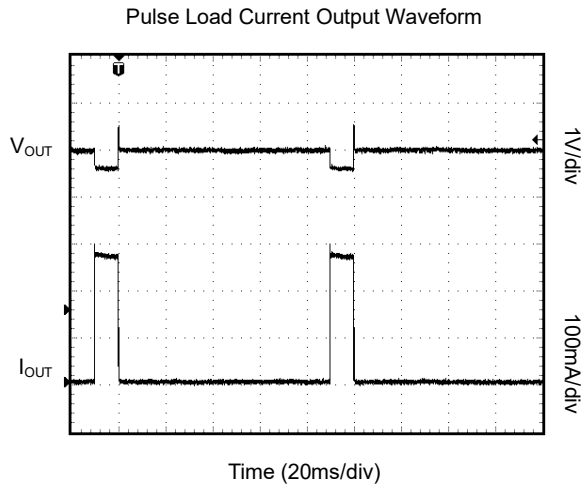

APPLICATION INFORMATION

Input Capacitor Selection (C_{IN})

The input decoupling capacitor should be placed as close as possible to the VIN pin for ensuring the device stability. 1 μ F or larger X7R or X5R ceramic capacitor is selected to get good dynamic performance.

When V_{IN} is required to provide large current instantaneously, a large effective input capacitor is required. Multiple input capacitors can limit the input tracking inductance. Adding more input capacitors is available to restrict the ringing and to keep it below the device absolute maximum ratings.

Output Capacitor Selection (C_{OUT})

The output capacitor should be placed as close as possible to the VOUT pin. C_{OUT} with the effective

capacitance in the range of 1 μ F to 10 μ F X7R or X5R ceramic capacitor is selected to get good dynamic performance. For ceramic capacitor, temperature, DC bias and package size will change the effective capacitance, so enough margin of C_{OUT} must be considered in design. Additionally, C_{OUT} with larger capacitance and lower ESR will help increase the high frequency PSRR and improve the load transient response.

Thermal Shutdown

When the die temperature exceeds the threshold value of thermal shutdown, the SGM2203 will be in shutdown state and it will remain in this state until the die temperature decreases to +130°C.

REVISION HISTORY

NOTE: Page numbers for previous revisions may differ from page numbers in the current version.

NOVEMBER 2023 – REV.A.3 to REV.A.4	Page
Updated Power Dissipation.....	3
Updated Package Thermal Resistance.....	3
JULY 2022 – REV.A.2 to REV.A.3	Page
Updated Package Thermal Resistance.....	3
OCTOBER 2020 – REV.A.1 to REV.A.2	Page
Updated Package/Ordering Information section.....	2
AUGUST 2017 – REV.A to REV.A.1	Page
Added SGM2203-3.5AYK3LG	1-2
Changes from Original (JULY 2017) to REV.A	Page
Changed from product preview to production data.....	All

PACKAGE OUTLINE DIMENSIONS

SOT-23

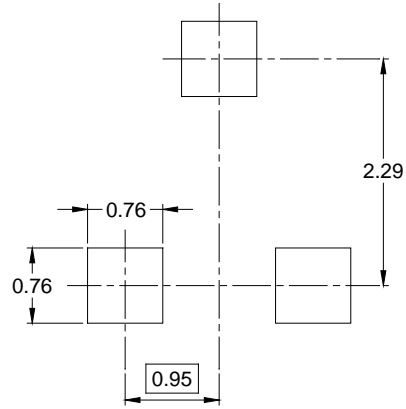
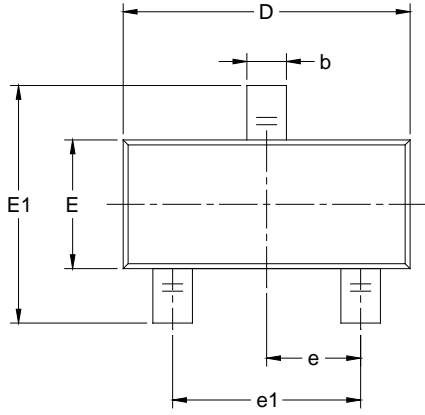

RECOMMENDED LAND PATTERN (Unit: mm)

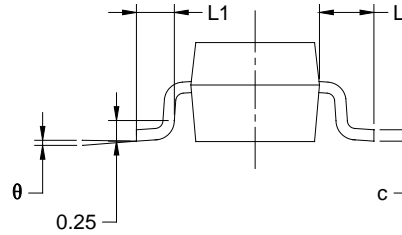
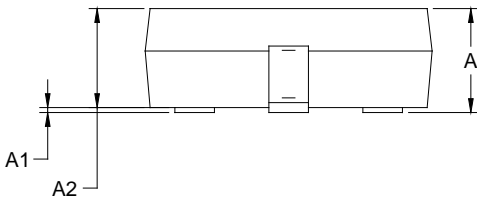

Symbol	Dimensions In Millimeters		Dimensions In Inches	
	MIN	MAX	MIN	MAX
A	0.900	1.150	0.035	0.045
A1	0.000	0.100	0.000	0.004
A2	0.900	1.050	0.035	0.041
b	0.300	0.500	0.012	0.020
c	0.080	0.150	0.003	0.006
D	2.800	3.000	0.110	0.118
E	1.200	1.400	0.047	0.055
E1	2.250	2.550	0.089	0.100
e	0.950 BSC		0.037 BSC	
e1	1.900 BSC		0.075 BSC	
L	0.550 REF		0.022 REF	
L1	0.300	0.500	0.012	0.020
θ	0°	8°	0°	8°

NOTES:

1. Body dimensions do not include mode flash or protrusion.
2. This drawing is subject to change without notice.

PACKAGE OUTLINE DIMENSIONS

SOT-23-5

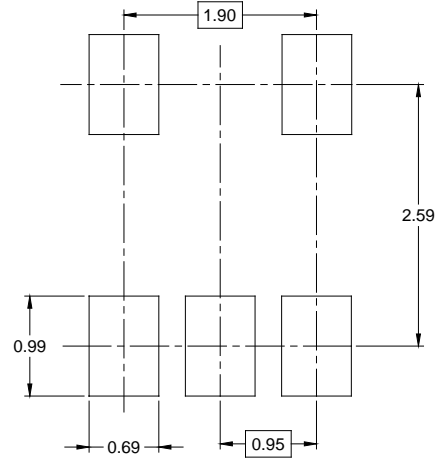
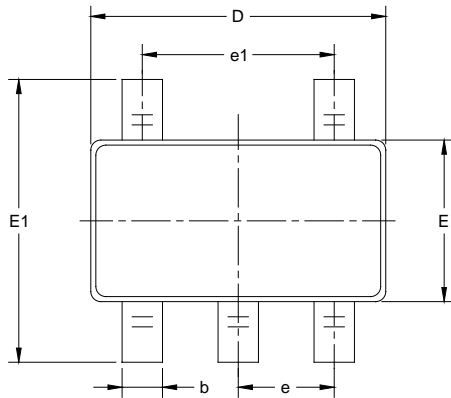

RECOMMENDED LAND PATTERN (Unit: mm)

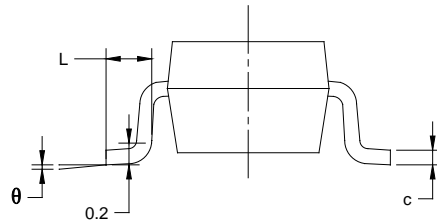
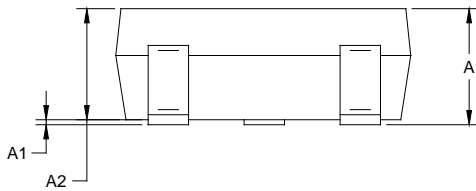

Symbol	Dimensions In Millimeters		Dimensions In Inches	
	MIN	MAX	MIN	MAX
A	1.050	1.250	0.041	0.049
A1	0.000	0.100	0.000	0.004
A2	1.050	1.150	0.041	0.045
b	0.300	0.500	0.012	0.020
c	0.100	0.200	0.004	0.008
D	2.820	3.020	0.111	0.119
E	1.500	1.700	0.059	0.067
E1	2.650	2.950	0.104	0.116
e	0.950 BSC		0.037 BSC	
e1	1.900 BSC		0.075 BSC	
L	0.300	0.600	0.012	0.024
θ	0°	8°	0°	8°

NOTES:

1. Body dimensions do not include mode flash or protrusion.
2. This drawing is subject to change without notice.

PACKAGE OUTLINE DIMENSIONS

SOT-89-3

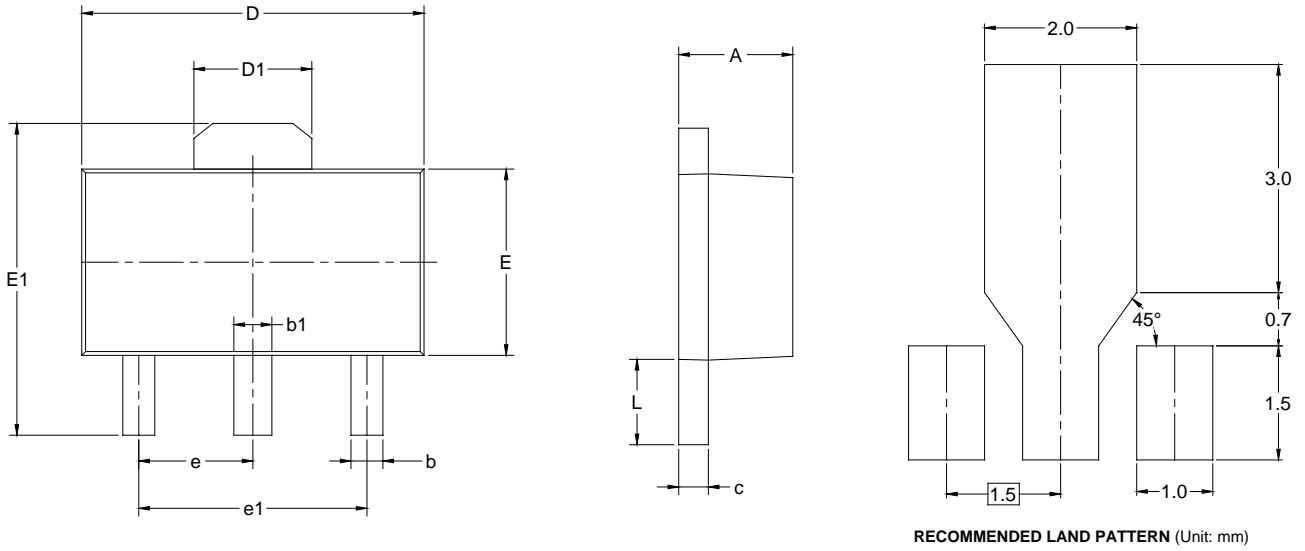

Symbol	Dimensions In Millimeters		Dimensions In Inches	
	MIN	MAX	MIN	MAX
A	1.400	1.600	0.055	0.063
b	0.320	0.520	0.013	0.020
b1	0.400	0.580	0.016	0.023
c	0.350	0.440	0.014	0.017
D	4.400	4.600	0.173	0.181
D1	1.550 REF		0.061 REF	
E	2.300	2.600	0.091	0.102
E1	3.940	4.250	0.155	0.167
e	1.500 TYP		0.060 TYP	
e1	3.000 TYP		0.118 TYP	
L	0.900	1.200	0.035	0.047

- NOTES:
1. Body dimensions do not include mode flash or protrusion.
 2. This drawing is subject to change without notice.

PACKAGE INFORMATION

TAPE AND REEL INFORMATION

REEL DIMENSIONS



TAPE DIMENSIONS



NOTE: The picture is only for reference. Please make the object as the standard.

KEY PARAMETER LIST OF TAPE AND REEL

Package Type	Reel Diameter	Reel Width W1 (mm)	A0 (mm)	B0 (mm)	K0 (mm)	P0 (mm)	P1 (mm)	P2 (mm)	W (mm)	Pin1 Quadrant
SOT-23	7"	9.5	3.15	2.77	1.22	4.0	4.0	2.0	8.0	Q3
SOT-23-5	7"	9.5	3.20	3.20	1.40	4.0	4.0	2.0	8.0	Q3
SOT-89-3	7"	13.2	4.85	4.45	1.85	4.0	8.0	2.0	12.0	Q3

DD0001

PACKAGE INFORMATION

CARTON BOX DIMENSIONS



NOTE: The picture is only for reference. Please make the object as the standard.

KEY PARAMETER LIST OF CARTON BOX

Reel Type	Length (mm)	Width (mm)	Height (mm)	Pizza/Carton
7" (Option)	368	227	224	8
7"	442	410	224	18

DD0002