



SGM8273-1/SGM8273-2/SGM8273-4

Low Noise, High Precision, High Voltage, Rail-to-Rail I/O Operational Amplifiers

GENERAL DESCRIPTION

The SGM8273-1 (single), SGM8273-2 (dual) and SGM8273-4 (quad) are low noise, high precision, high voltage operational amplifiers that are designed to offer a wide input common mode voltage range and output voltage swing. These devices can operate from $\pm 1.65V$ to $\pm 18V$ dual power supplies or from 3.3V to 36V single supply.

The devices feature low noise, high slew rate, low input bias and offset current, low offset voltage and low offset voltage temperature coefficient.

The SGM8273-1/2/4 are specified over the extended $-40^{\circ}C$ to $+125^{\circ}C$ temperature range. The single SGM8273-1 is available in Green SOT-23-5, SOIC-8 and MSOP-8 packages. The dual SGM8273-2 is available in a Green SOIC-8 package. The quad SGM8273-4 is available in a Green SOIC-14 package.

FEATURES

- **Wide Input Common Mode and Differential Voltage Ranges**
- **Low Input Bias and Offset Current**
- **Output Short-Circuit Protection**
- **Rail-to-Rail Input and Output**
- **High Input Impedance**
- **Low Offset Voltage: 1mV (MAX)**
- **Low Noise: $9nV/\sqrt{Hz}$ at 1kHz**
- **Gain-Bandwidth Product: 4MHz**
- **High Slew Rate: 6V/ μs**
- **Small Packaging:**
 - SGM8273-1 Available in Green SOT-23-5, SOIC-8 and MSOP-8 Packages**
 - SGM8273-2 Available in a Green SOIC-8 Package**
 - SGM8273-4 Available in a Green SOIC-14 Package**

APPLICATIONS

High Impedance Sensor
Photodiode Amplifier
High End, Professional Audio
DAC Output Amplifier
Medical

PACKAGE/ORDERING INFORMATION

MODEL	PACKAGE DESCRIPTION	SPECIFIED TEMPERATURE RANGE	ORDERING NUMBER	PACKAGE MARKING	PACKING OPTION
SGM8273-1	SOT-23-5	-40°C to +125°C	SGM8273-1AXN5G/TR	GIDXX	Tape and Reel, 3000
	SOT-23-5	-40°C to +125°C	SGM8273-1BXN5G/TR	GIEXX	Tape and Reel, 3000
	SOIC-8	-40°C to +125°C	SGM8273-1XS8G/TR	SGM 82731XS8 XXXXX	Tape and Reel, 4000
	MSOP-8	-40°C to +125°C	SGM8273-1XMS8G/TR	SGM82731 XMS8 XXXXX	Tape and Reel, 4000
SGM8273-2	SOIC-8	-40°C to +125°C	SGM8273-2XS8G/TR	SGM 82732XS8 XXXXX	Tape and Reel, 4000
SGM8273-4	SOIC-14	-40°C to +125°C	SGM8273-4XS14G/TR	SGM82734XS14 XXXXX	Tape and Reel, 2500

MARKING INFORMATION

NOTE: XX = Date Code. XXXXX = Date Code and Vendor Code.

SOT-23-5

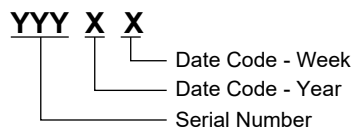

SOIC-8/MSOP-8/SOIC-14

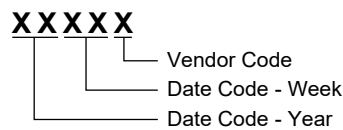

Green (RoHS & HSF): SG Micro Corp defines "Green" to mean Pb-Free (RoHS compatible) and free of halogen substances. If you have additional comments or questions, please contact your SGMICRO representative directly.

ABSOLUTE MAXIMUM RATINGS

Supply Voltage, +Vs to -Vs	40V
Input/Output Voltage Range	(-Vs) - 0.3V to (+Vs) + 0.3V
Junction Temperature	+150°C
Storage Temperature Range	-65°C to +150°C
Lead Temperature (Soldering, 10s)	+260°C
ESD Susceptibility	
HBM (SGM8273-1)	5000V
HBM (SGM8273-2/4)	6000V
MM (SGM8273-1)	200V
MM (SGM8273-2/4)	300V
CDM	1000V

RECOMMENDED OPERATING CONDITIONS

Operating Temperature Range	-40°C to +125°C
-----------------------------------	-----------------

NOTE:

1. Proper power supply sequencing is recommended for the CMOS device. Always sequence Vs on first, followed by the inputs and outputs.

OVERSTRESS CAUTION

Stresses beyond those listed in Absolute Maximum Ratings may cause permanent damage to the device. Exposure to absolute maximum rating conditions for extended periods may affect reliability. Functional operation of the device at any conditions beyond those indicated in the Recommended Operating Conditions section is not implied.

ESD SENSITIVITY CAUTION

This integrated circuit can be damaged by ESD if you don't pay attention to ESD protection. SGMICRO recommends that all integrated circuits be handled with appropriate precautions. Failure to observe proper handling and installation procedures can cause damage. ESD damage can range from subtle performance degradation to complete device failure. Precision integrated circuits may be more susceptible to damage because very small parametric changes could cause the device not to meet its published specifications.

DISCLAIMER

SG Micro Corp reserves the right to make any change in circuit design, or specifications without prior notice.

PIN CONFIGURATIONS

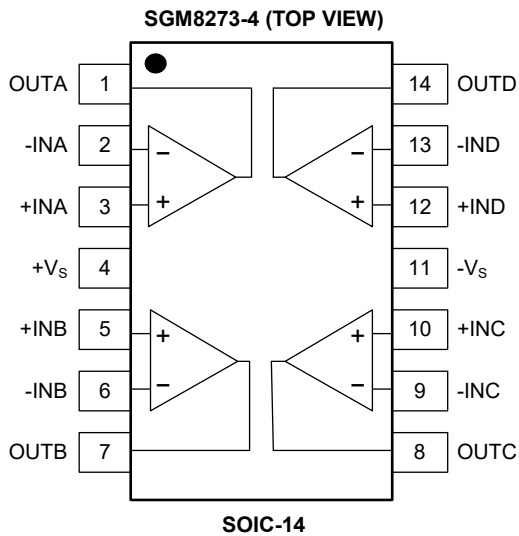
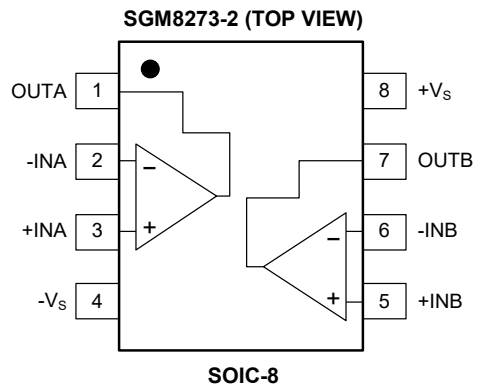
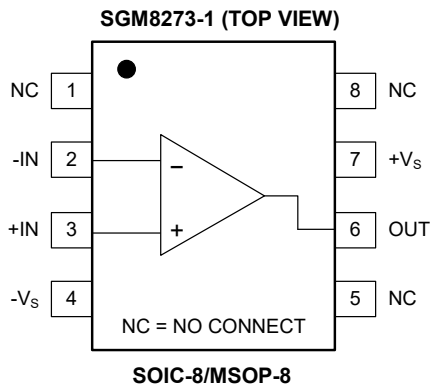
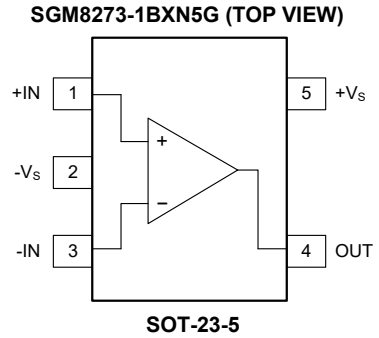
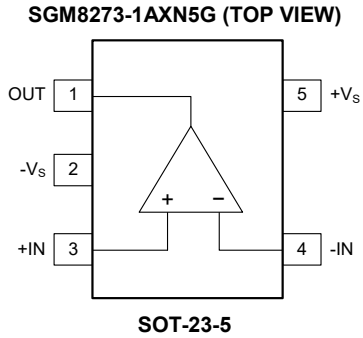

ELECTRICAL CHARACTERISTICS

(At T_A = +25°C, V_S = ±1.65V to ±18V and R_L = 2kΩ connected to 0V, Full = -40°C to +125°C, unless otherwise noted.)

PARAMETER	SYMBOL	CONDITIONS	TEMP	MIN	TYP	MAX	UNITS
Input Characteristics							
Input Offset Voltage	V _{OS}	V _{CM} = 0V	+25°C		0.5	1	mV
			Full			1.8	
Input Offset Voltage Drift	ΔV _{OS} /ΔT		Full		2		μV/°C
Input Bias Current	I _B	V _{CM} = 0V	+25°C		±10	±300	pA
Input Offset Current	I _{OS}	V _{CM} = 0V	+25°C		±10		pA
Input Common Mode Voltage Range	V _{CM}		Full	(-V _S) - 0.1		(+V _S) + 0.1	V
Maximum Differential Input Voltage	V _{ID}		Full			V _S	V
Maximum Differential Input Current	I _{ID}	V _S = ±18V, V _{ID} = ±18V	+25°C		2	3	μA
			Full			4	
Common Mode Rejection Ratio	CMRR	V _S = ±18V, (-V _S) - 0.1V ≤ V _{CM} ≤ (+V _S) - 1.5V	+25°C	100	115		dB
			Full	98			
		V _S = ±18V, (-V _S) - 0.1V ≤ V _{CM} ≤ (+V _S) + 0.1V	+25°C	72	86		
			Full	70			
Open-Loop Voltage Gain	A _{OL}	(-V _S) + 0.2V < V _{OUT} < (+V _S) - 0.2V, R _L = 10kΩ	+25°C	96	110		dB
			Full	88			
		(-V _S) + 0.5V < V _{OUT} < (+V _S) - 0.5V, R _L = 2kΩ	+25°C	80	90		
			Full	74			
Output Characteristics							
Output Voltage Swing from Rail	V _{OUT}	V _S = ±18V, R _L = 10kΩ	+25°C		60	90	mV
			Full			120	
		V _S = ±18V, R _L = 2kΩ	+25°C		300	400	
			Full			550	
Output Short-Circuit Current	I _{SC}	V _S = ±18V	+25°C	±18	±40		mA
Power Supply							
Operating Voltage Range	V _S		Full	3.3		36	V
Quiescent Current/Amplifier	I _Q	I _{OUT} = 0	+25°C		0.6	0.9	mA
			Full			1	
Power Supply Rejection Ratio	PSRR	V _S = 3.3V to 36V	+25°C	110	125		dB
			Full	108			
Dynamic Performance							
Gain-Bandwidth Product	GBP	C _L = 50pF	+25°C		4		MHz
Slew Rate	SR	V _S = ±2.5V to ±18V, G = +1	+25°C		6		V/μs
Overload Recovery Time	ORT	V _{IN} × G > V _S	+25°C		1		μs
Total Harmonic Distortion + Noise	THD+N	V _S = ±2.5V to ±18V, V _{OUT} = 2V _{P-P} , f = 1kHz, G = +1, R _L = 600Ω	+25°C		0.005		%
			+25°C		0.0005		
Noise							
Input Voltage Noise		f = 0.1Hz to 10Hz	+25°C		1.5		μV _{P-P}
Input Voltage Noise Density	e _n	f = 10Hz	+25°C		35		nV/√Hz
		f = 1kHz	+25°C		9		
Input Current Noise Density	i _n	f = 1kHz	+25°C		700		fA/√Hz

TYPICAL PERFORMANCE CHARACTERISTICS

At $T_A = +25^\circ\text{C}$, $V_S = 36\text{V}$ and $R_L = 2\text{k}\Omega$, unless otherwise noted.

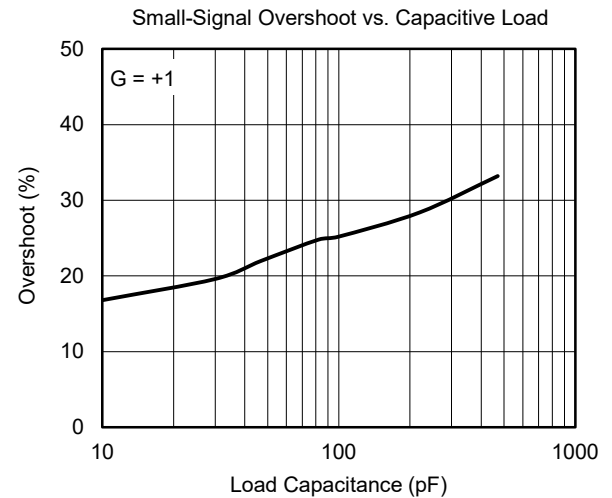
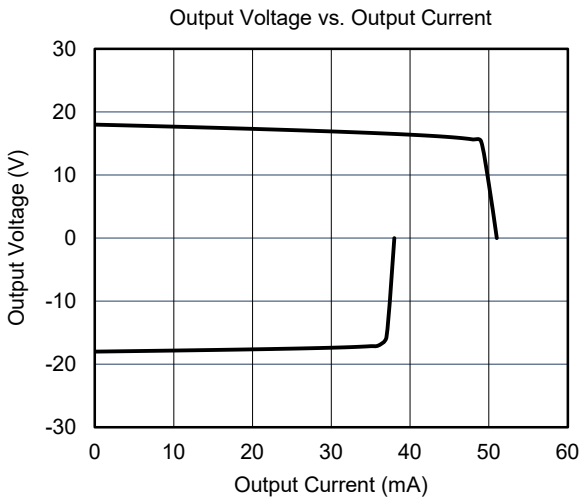
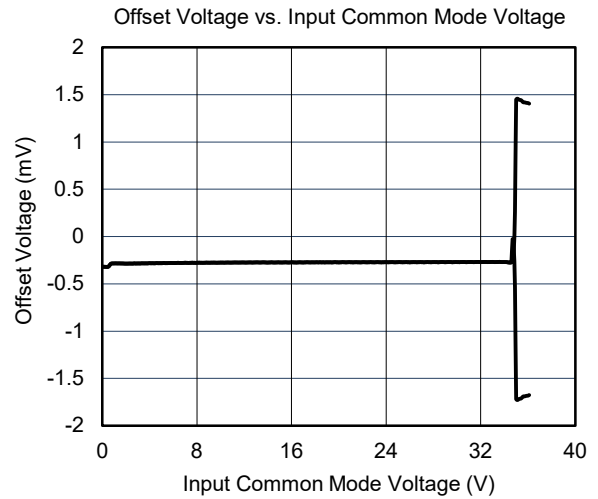
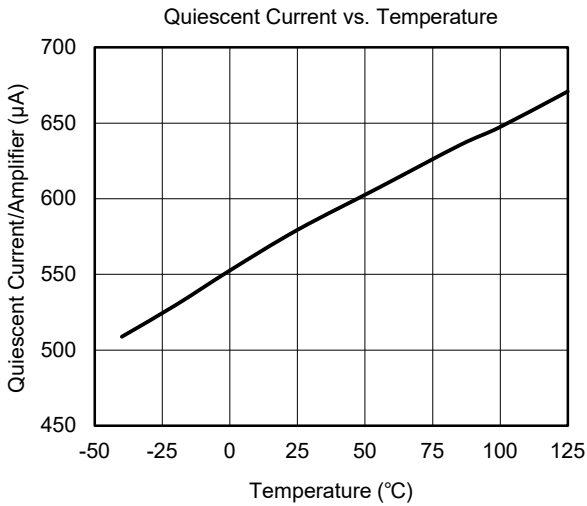
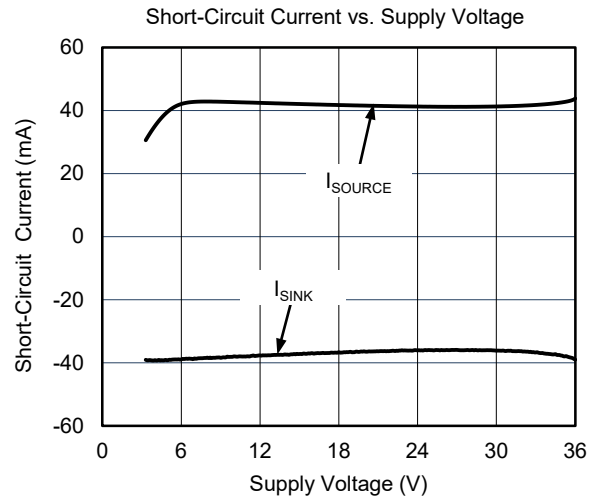
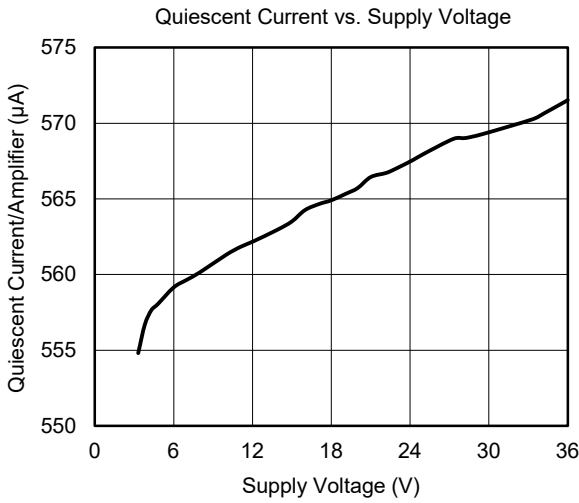

TYPICAL PERFORMANCE CHARACTERISTICS (continued)

At $T_A = +25^\circ\text{C}$, $V_S = 36\text{V}$ and $R_L = 2\text{k}\Omega$, unless otherwise noted.

Large-Signal Step Response

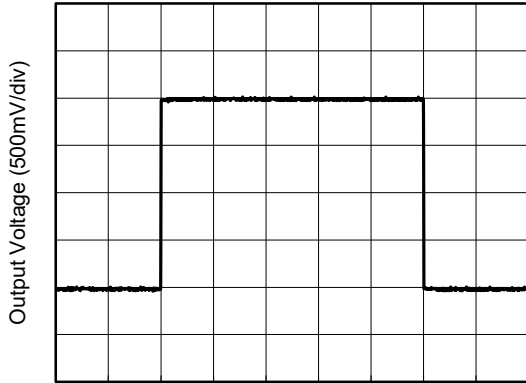

Time (100µs/div)

Small-Signal Step Response

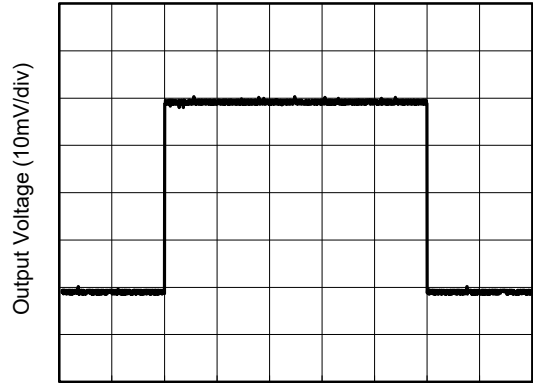

Time (100µs/div)

CMRR and PSRR vs. Frequency

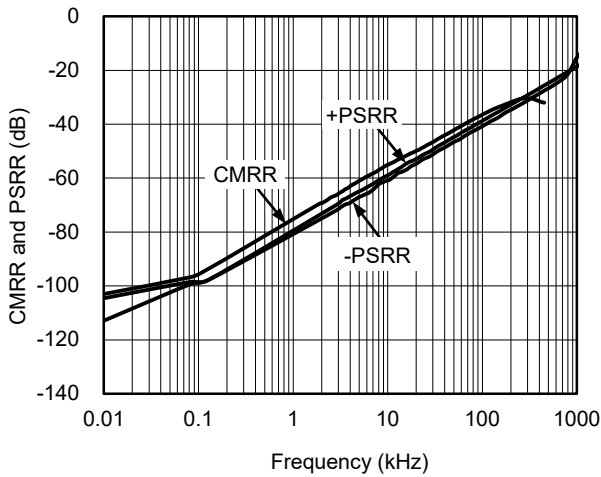

Frequency (kHz)

Open-Loop Gain and Phase vs. Frequency

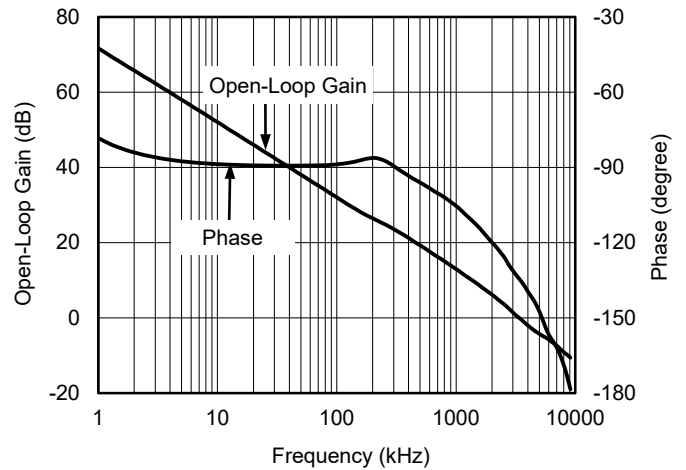

Frequency (kHz)

Maximum Output Voltage vs. Frequency

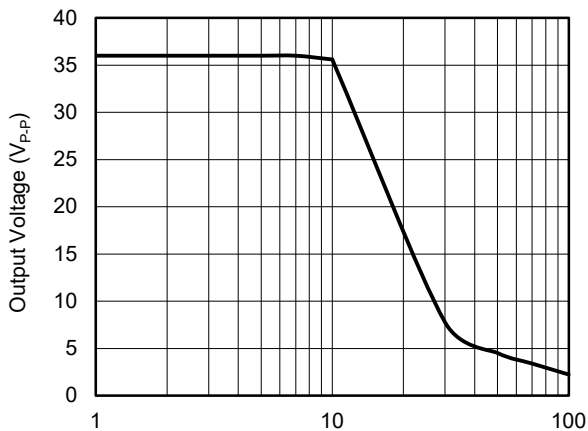

Frequency (kHz)

Input Voltage Noise Density vs. Frequency

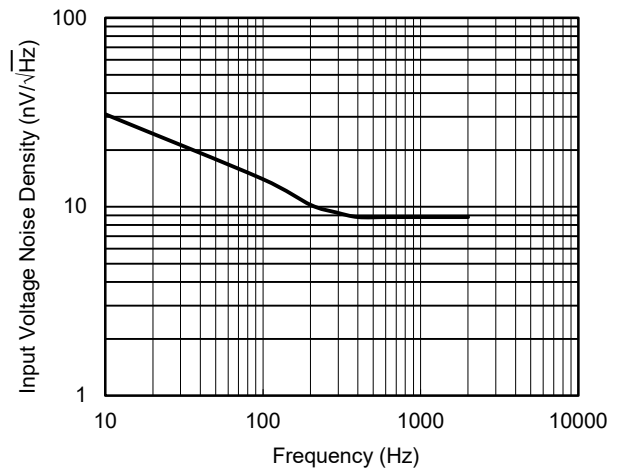

Frequency (Hz)

TYPICAL PERFORMANCE CHARACTERISTICS (continued)

At $T_A = +25^\circ\text{C}$, $V_S = 36\text{V}$ and $R_L = 2\text{k}\Omega$, unless otherwise noted.

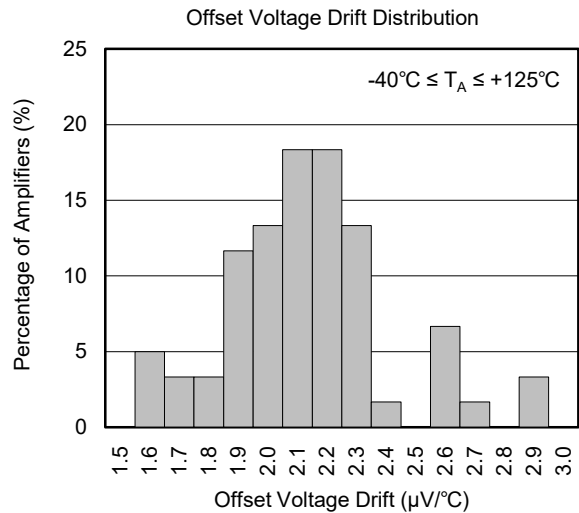
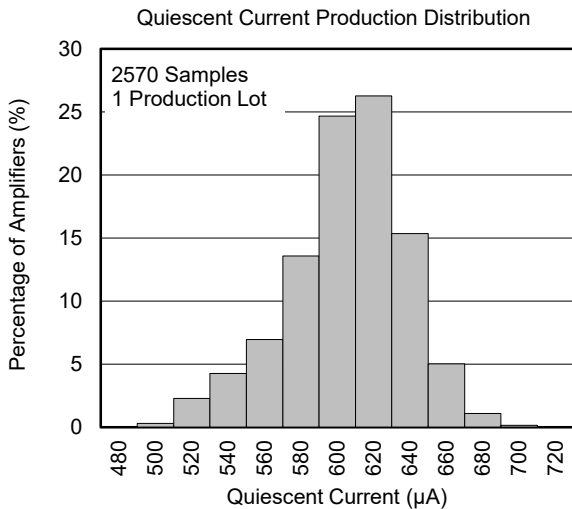
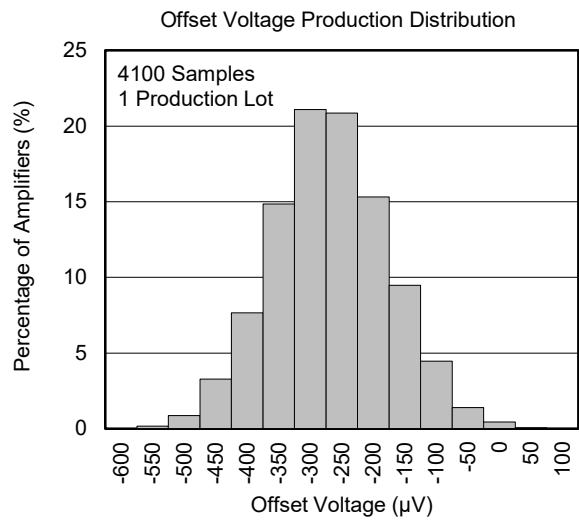
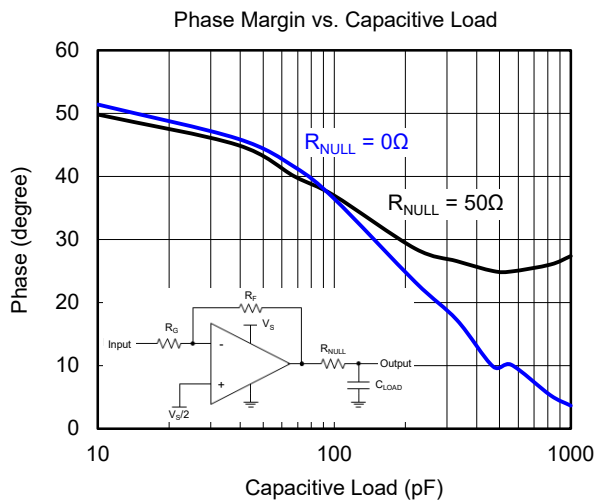
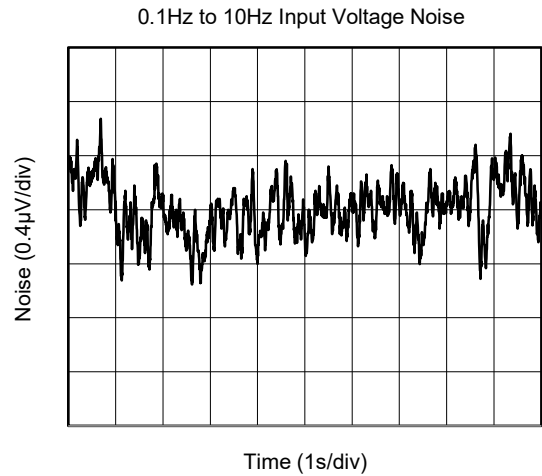
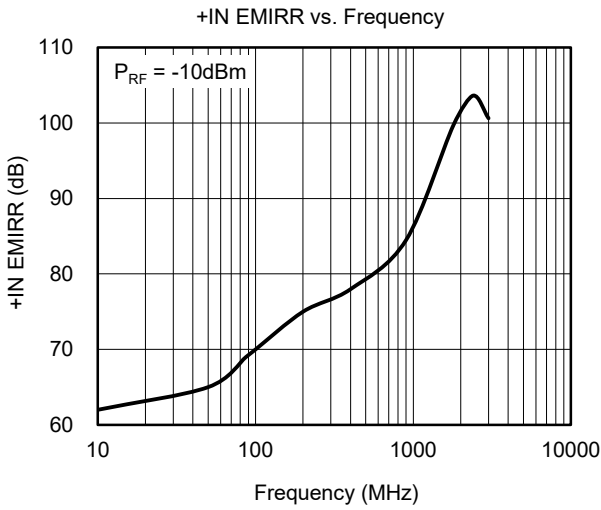

REVISION HISTORY

NOTE: Page numbers for previous revisions may differ from page numbers in the current version.

	Page
<hr/>	
OCTOBER 2019 – REV.A.2 to REV.A.3	Page
Updated Marking Information section.....	2
<hr/>	
NOVEMBER 2018 – REV.A.1 to REV.A.2	Page
Added Phase Margin vs. Capacitive Load	7
<hr/>	
OCTOBER 2017 – REV.A to REV.A.1	Page
Updated Electrical Characteristics section	4
<hr/>	
Changes from Original (AUGUST 2017) to REV.A	Page
Changed from product preview to production data.....	All
<hr/>	

PACKAGE INFORMATION

PACKAGE OUTLINE DIMENSIONS

SOT-23-5

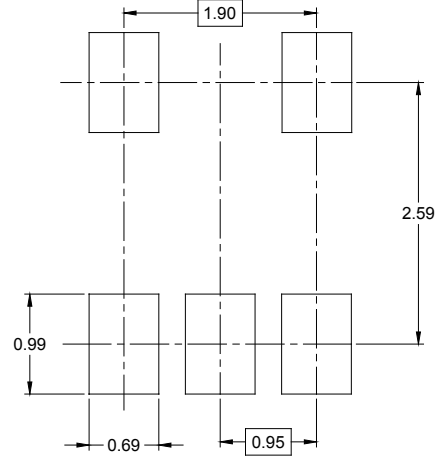
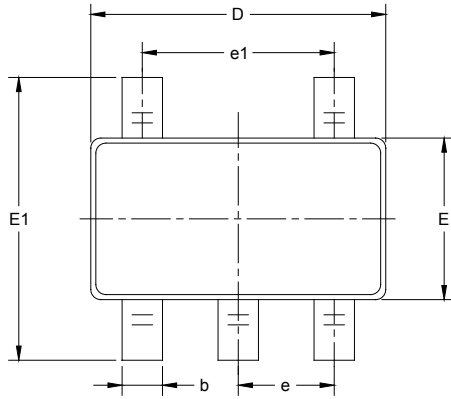

RECOMMENDED LAND PATTERN (Unit: mm)

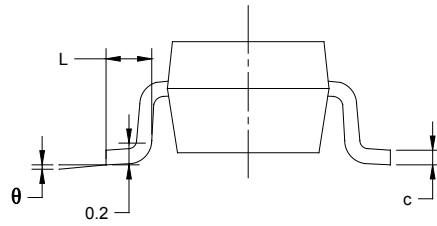
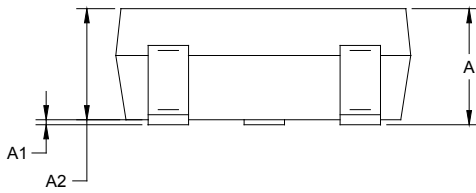

Symbol	Dimensions In Millimeters		Dimensions In Inches	
	MIN	MAX	MIN	MAX
A	1.050	1.250	0.041	0.049
A1	0.000	0.100	0.000	0.004
A2	1.050	1.150	0.041	0.045
b	0.300	0.500	0.012	0.020
c	0.100	0.200	0.004	0.008
D	2.820	3.020	0.111	0.119
E	1.500	1.700	0.059	0.067
E1	2.650	2.950	0.104	0.116
e	0.950 BSC		0.037 BSC	
e1	1.900 BSC		0.075 BSC	
L	0.300	0.600	0.012	0.024
θ	0°	8°	0°	8°

PACKAGE OUTLINE DIMENSIONS

SOIC-8

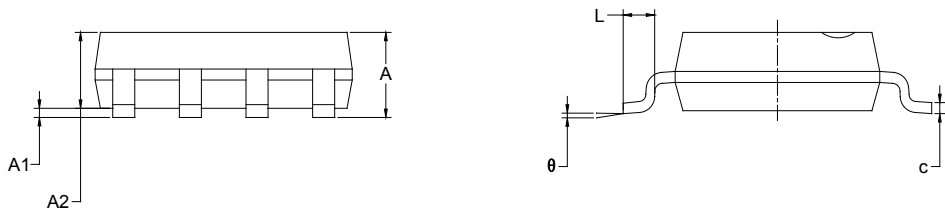
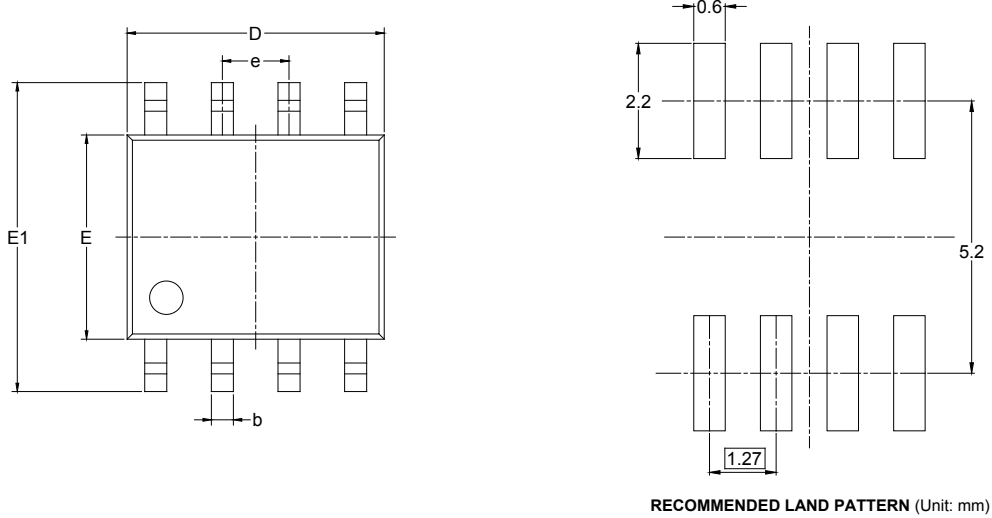

Symbol	Dimensions In Millimeters		Dimensions In Inches	
	MIN	MAX	MIN	MAX
A	1.350	1.750	0.053	0.069
A1	0.100	0.250	0.004	0.010
A2	1.350	1.550	0.053	0.061
b	0.330	0.510	0.013	0.020
c	0.170	0.250	0.006	0.010
D	4.700	5.100	0.185	0.200
E	3.800	4.000	0.150	0.157
E1	5.800	6.200	0.228	0.244
e	1.27 BSC		0.050 BSC	
L	0.400	1.270	0.016	0.050
θ	0°	8°	0°	8°

PACKAGE OUTLINE DIMENSIONS

MSOP-8



RECOMMENDED LAND PATTERN (Unit: mm)

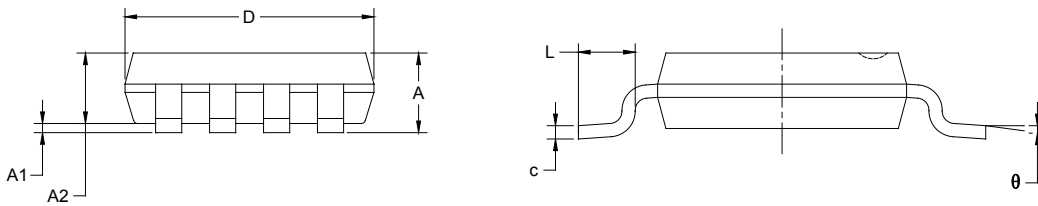

Symbol	Dimensions In Millimeters		Dimensions In Inches	
	MIN	MAX	MIN	MAX
A	0.820	1.100	0.032	0.043
A1	0.020	0.150	0.001	0.006
A2	0.750	0.950	0.030	0.037
b	0.250	0.380	0.010	0.015
c	0.090	0.230	0.004	0.009
D	2.900	3.100	0.114	0.122
E	2.900	3.100	0.114	0.122
E1	4.750	5.050	0.187	0.199
e	0.650 BSC		0.026 BSC	
L	0.400	0.800	0.016	0.031
θ	0°	6°	0°	6°

PACKAGE OUTLINE DIMENSIONS

SOIC-14

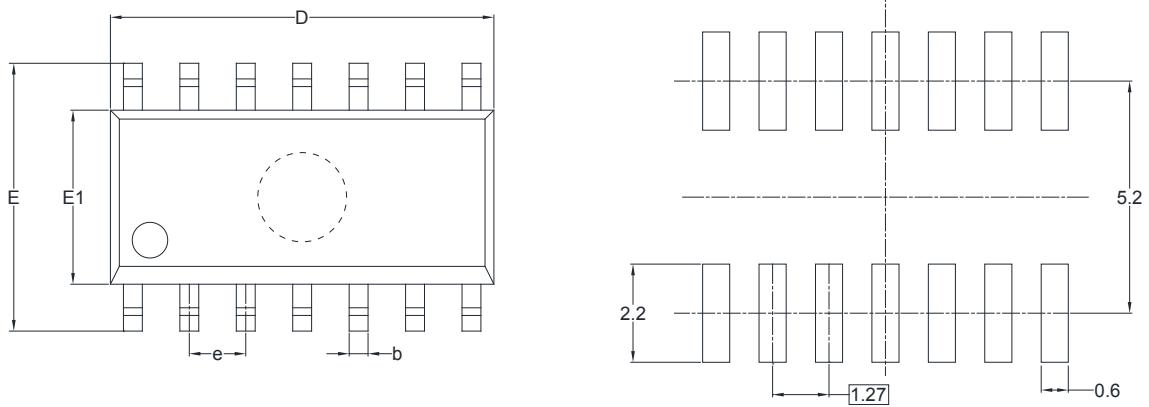

RECOMMENDED LAND PATTERN (Unit: mm)

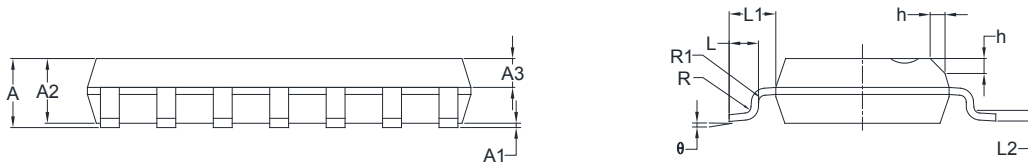

Symbol	Dimensions In Millimeters		Dimensions In Inches	
	MIN	MAX	MIN	MAX
A	1.35	1.75	0.053	0.069
A1	0.10	0.25	0.004	0.010
A2	1.25	1.65	0.049	0.065
A3	0.55	0.75	0.022	0.030
b	0.36	0.49	0.014	0.019
D	8.53	8.73	0.336	0.344
E	5.80	6.20	0.228	0.244
E1	3.80	4.00	0.150	0.157
e	1.27 BSC		0.050 BSC	
L	0.45	0.80	0.018	0.032
L1	1.04 REF		0.040 REF	
L2	0.25 BSC		0.01 BSC	
R	0.07		0.003	
R1	0.07		0.003	
h	0.30	0.50	0.012	0.020
θ	0°	8°	0°	8°

PACKAGE INFORMATION

TAPE AND REEL INFORMATION

REEL DIMENSIONS



TAPE DIMENSIONS



NOTE: The picture is only for reference. Please make the object as the standard.

KEY PARAMETER LIST OF TAPE AND REEL

Package Type	Reel Diameter	Reel Width W1 (mm)	A0 (mm)	B0 (mm)	K0 (mm)	P0 (mm)	P1 (mm)	P2 (mm)	W (mm)	Pin1 Quadrant
SOT-23-5	7"	9.5	3.20	3.20	1.40	4.0	4.0	2.0	8.0	Q3
SOIC-8	13"	12.4	6.40	5.40	2.10	4.0	8.0	2.0	12.0	Q1
MSOP-8	13"	12.4	5.20	3.30	1.50	4.0	8.0	2.0	12.0	Q1
SOIC-14	13"	16.4	6.60	9.30	2.10	4.0	8.0	2.0	16.0	Q1

DD0001

PACKAGE INFORMATION

CARTON BOX DIMENSIONS



NOTE: The picture is only for reference. Please make the object as the standard.

KEY PARAMETER LIST OF CARTON BOX

Reel Type	Length (mm)	Width (mm)	Height (mm)	Pizza/Carton
7" (Option)	368	227	224	8
7"	442	410	224	18
13"	386	280	370	5

DD0002