

GENERAL DESCRIPTION

The SGM2030 series low-power, low-dropout, CMOS linear voltage regulators operate from a 2.5V to 5.5V input voltage in an ultra small package. They are the perfect choice for low voltage, low power applications. A low ground current makes this part attractive for battery operated power systems. The SGM2030 series also offer ultra low dropout voltage to prolong battery life in portable electronics. Systems requiring a quiet voltage source, such as RF applications, will benefit from the SGM2030 series' low output noise and high PSRR.

Other features include a 10nA logic-controlled shutdown mode, foldback current limit and thermal shut-down protection.

The SGM2030 is available in a Green UTDFN-1.2×1.6-4L package. It operates over an ambient temperature range of -40°C to +85°C.

FEATURES

- Low Dropout Voltage
- Thermal-Overload Protection
- Output Current Limit
- High PSRR (71dB at 1kHz)
- 10nA Logic-Controlled Shutdown
- Available in Multiple Output Voltage Versions
- Fixed Outputs of 1.2V, 1.5V, 1.8V, 2.5V, 2.6V, 2.8V, 2.85V, 3.0V and 3.3V
- -40°C to +85°C Operating Temperature Range
- Available in a Green UTDFN-1.2×1.6-4L Package

APPLICATIONS

- Cellular Telephones
- Cordless Telephones
- PHS Telephones
- PCMCIA Cards
- Modems
- MP3 Player
- Hand-Held Instruments
- Palmtop Computers
- Electronic Planners
- Portable/Battery-Powered Equipment

TYPICAL APPLICATION

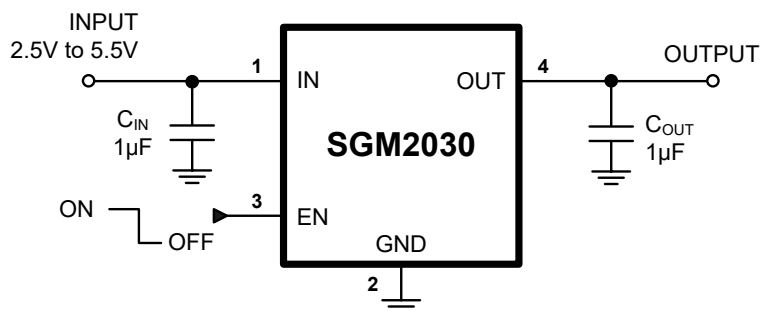

Figure 1. Typical Application Circuit

SGM2030

PACKAGE/ORDERING INFORMATION

MODEL	V _{OUT} (V)	PACKAGE DESCRIPTION	SPECIFIED TEMPERATURE RANGE	ORDERING NUMBER	PACKAGE MARKING	PACKING OPTION
SGM2030-1.2	1.2V	UTDFN-1.2×1.6-4L	-40°C to +85°C	SGM2030-1.2YUDG4G/TR	63X	Tape and Reel, 5000
SGM2030-1.5	1.5V	UTDFN-1.2×1.6-4L	-40°C to +85°C	SGM2030-1.5YUDG4G/TR	9DX	Tape and Reel, 5000
SGM2030-1.8	1.8V	UTDFN-1.2×1.6-4L	-40°C to +85°C	SGM2030-1.8YUDG4G/TR	4EX	Tape and Reel, 5000
SGM2030-2.5	2.5V	UTDFN-1.2×1.6-4L	-40°C to +85°C	SGM2030-2.5YUDG4G/TR	9EX	Tape and Reel, 5000
SGM2030-2.6	2.6V	UTDFN-1.2×1.6-4L	-40°C to +85°C	SGM2030-2.6YUDG4G/TR	68X	Tape and Reel, 5000
SGM2030-2.8	2.8V	UTDFN-1.2×1.6-4L	-40°C to +85°C	SGM2030-2.8YUDG4G/TR	4FX	Tape and Reel, 5000
SGM2030-2.85	2.85V	UTDFN-1.2×1.6-4L	-40°C to +85°C	SGM2030-2.85YUDG4G/TR	BAX	Tape and Reel, 5000
SGM2030-3.0	3.0V	UTDFN-1.2×1.6-4L	-40°C to +85°C	SGM2030-3.0YUDG4G/TR	50X	Tape and Reel, 5000
SGM2030-3.3	3.3V	UTDFN-1.2×1.6-4L	-40°C to +85°C	SGM2030-3.3YUDG4G/TR	56X	Tape and Reel, 5000

Green (RoHS & HSF): SG Micro Corp defines "Green" to mean Pb-Free (RoHS compatible) and free of halogen substances. If you have additional comments or questions, please contact your SGMICRO representative directly.

ORDER NUMBER

SGM2030 - X X X G / TR

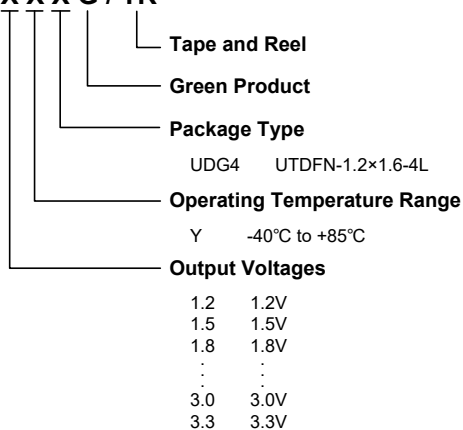

MARKING INFORMATION

NOTE: X = Date Code.

YY X

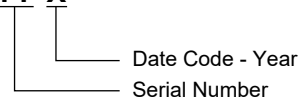

SGM2030

ABSOLUTE MAXIMUM RATINGS

IN to GND	-0.3V to 6V
Output Short-Circuit Duration.....	Infinite
EN to GND.....	-0.3V to V_{IN}
OUT to GND	-0.3V to ($V_{IN} + 0.3V$)
Package Thermal Resistance	
UTDFN-1.2×1.6-4L, θ_{JA}	148°C/W
Junction Temperature.....	+150°C
Storage Temperature Range	-65°C to +150°C
Lead Temperature (Soldering, 10s).....	+260°C
ESD Susceptibility	
HBM.....	4000V
MM.....	400V

RECOMMENDED OPERATING CONDITIONS

Operating Temperature Range	-40°C to +85°C
-----------------------------------	----------------

OVERSTRESS CAUTION

Stresses beyond those listed in Absolute Maximum Ratings may cause permanent damage to the device. Exposure to absolute maximum rating conditions for extended periods may affect reliability. Functional operation of the device at any conditions beyond those indicated in the Recommended Operating Conditions section is not implied.

ESD SENSITIVITY CAUTION

This integrated circuit can be damaged by ESD if you don't pay attention to ESD protection. SGMICRO recommends that all integrated circuits be handled with appropriate precautions. Failure to observe proper handling and installation procedures can cause damage. ESD damage can range from subtle performance degradation to complete device failure. Precision integrated circuits may be more susceptible to damage because very small parametric changes could cause the device not to meet its published specifications.

DISCLAIMER

SG Micro Corp reserves the right to make any change in circuit design, or specifications without prior notice.

PIN CONFIGURATION

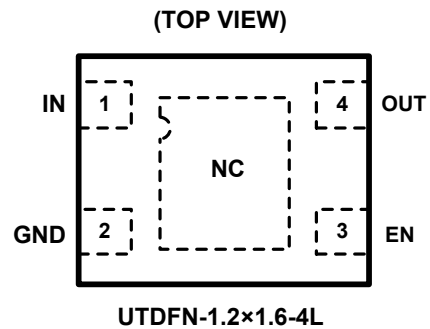

PIN DESCRIPTION

PIN	NAME	FUNCTION
1	IN	Regulator Input. Supply voltage can range from 2.5V to 5.5V. Bypass with a 1µF capacitor to GND.
2	GND	Ground.
3	EN	Shutdown Input. A logic low reduces the supply current to 10nA. Connect to IN for normal operation.
4	OUT	Regulator Output.
Exposed Pad	NC	No Connection.

ELECTRICAL CHARACTERISTICS

(V_{IN} = V_{OUT (NOMINAL)} + 0.5V⁽¹⁾, Full = -40°C to +85°C, unless otherwise noted.)

PARAMETER	SYMBOL	CONDITIONS	TEMP	MIN	TYP	MAX	UNITS	
Input Voltage	V _{IN}		+25°C	2.5		5.5	V	
Output Voltage Accuracy ⁽¹⁾		I _{OUT} = 0.1mA	+25°C	-3		+3	%	
Maximum Output Current ⁽¹⁾			+25°C	300			mA	
Current Limit ⁽¹⁾	I _{LIM}		+25°C	310			mA	
Ground Pin Current	I _Q	No load, EN = 2V	+25°C		95	200	μA	
Dropout Voltage ⁽²⁾		I _{OUT} = 1mA	+25°C		0.9		mV	
		I _{OUT} = 300mA			270	400		
Line Regulation ⁽¹⁾	ΔV _{LNR}	V _{IN} = 2.5V or (V _{OUT} + 0.5V) to 5.5V, I _{OUT} = 1mA	+25°C		0.02	0.05	%/V	
Load Regulation	ΔV _{LDR}	I _{OUT} = 0.1mA to 300mA, C _{OUT} = 1μF, V _{OUT} > 2V	+25°C		0.002	0.005	%mA	
		I _{OUT} = 0.1mA to 300mA, C _{OUT} = 1μF, V _{OUT} ≤ 2V			0.004	0.008		
Output Voltage Noise	e _n	f = 10Hz to 100kHz, C _{OUT} = 10μF	+25°C		140		μV _{RMS}	
Power Supply Rejection Ratio	PSRR	I _{OUT} = 50mA, C _{OUT} = 1μF, V _{IN} = V _{OUT} + 1V	f = 217Hz	+25°C		72		dB
			f = 1kHz	+25°C		71		dB
Shutdown⁽³⁾								
EN Input Threshold	V _{IH}	V _{IN} = 2.5V to 5.5V, V _{EN} = -0.3V to V _{IN}	Full		1.5		V	
	V _{IL}		Full			0.3		
EN Input Bias Current	I _{B(SHDN)}	EN = 0V and EN = 5.5V	+25°C		0.01	1	μA	
			Full		0.01			
Shutdown Supply Current	I _{Q(SHDN)}	EN = 0.4V	+25°C		0.01	1	μA	
			Full		0.01			
Shutdown Exit Delay ⁽⁴⁾		C _{OUT} = 1μF, No Load	+25°C		10		μs	
Thermal Protection								
Thermal Shutdown Temperature	T _{SHDN}				150		°C	
Thermal Shutdown Hysteresis	ΔT _{SHDN}				15		°C	

NOTES:

- V_{IN} = V_{OUT (NOMINAL)} + 0.5V or 2.5V, whichever is greater.
- The dropout voltage is defined as V_{IN} - V_{OUT}, when V_{OUT} is 100mV below the value of V_{OUT} for V_{IN} = V_{OUT} + 0.5V.
(Only applicable for V_{OUT} = +2.5V to +5.0V.)
- V_{EN} = -0.3V to V_{IN}
- Time needed for V_{OUT} to reach 90% of final value.

TYPICAL PERFORMANCE CHARACTERISTICS

$V_{IN} = V_{OUT (NOMINAL)} + 0.5V$ or $2.5V$ (whichever is greater), $C_{IN} = 1\mu F$, $C_{OUT} = 1\mu F$, $T_A = +25^\circ C$, unless otherwise noted.

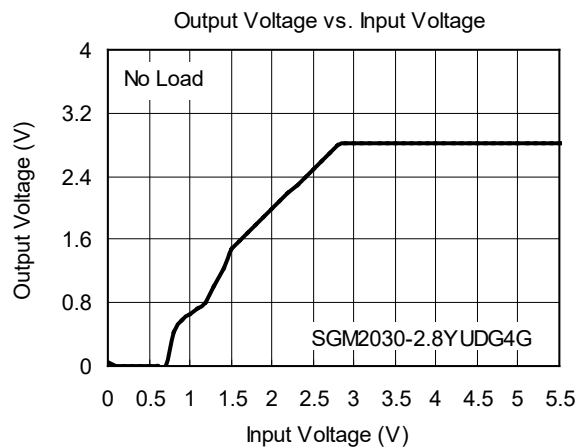
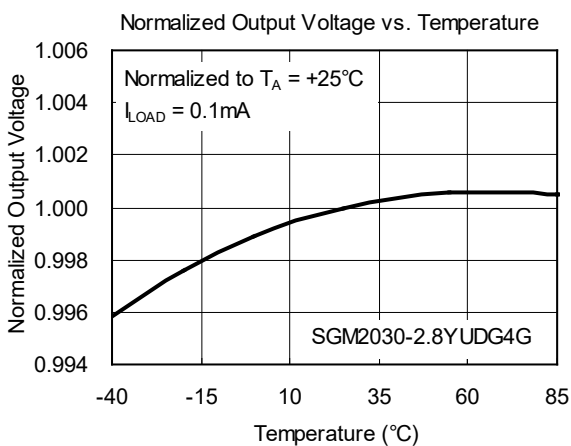
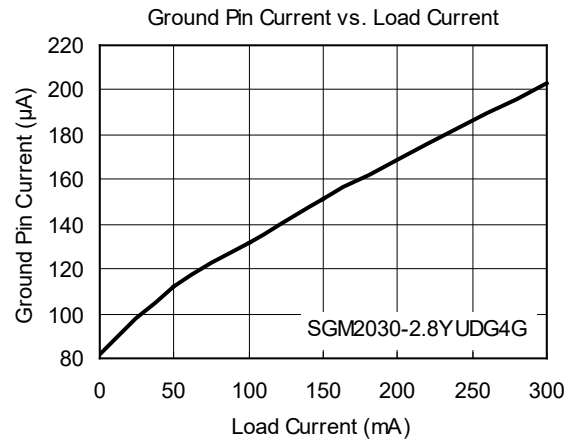
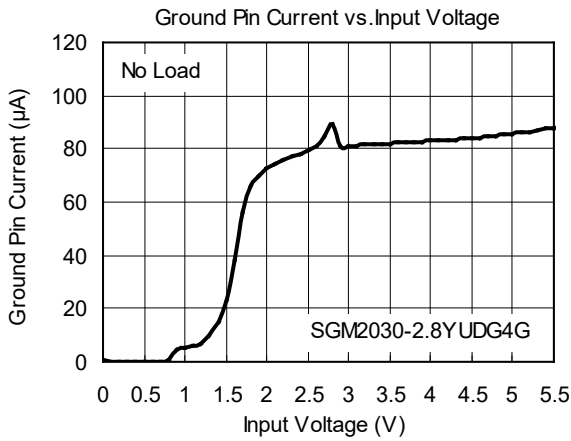
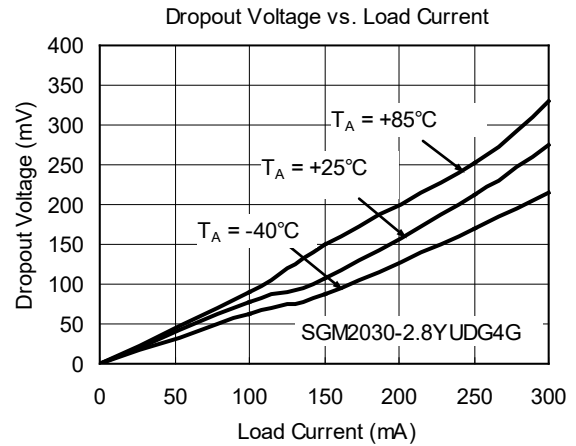
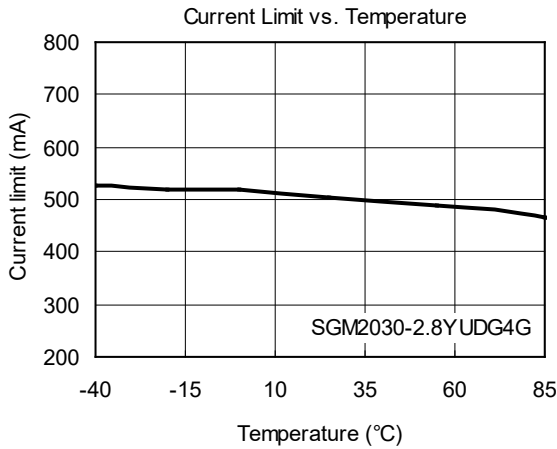

TYPICAL PERFORMANCE CHARACTERISTICS (continued)

$V_{IN} = V_{OUT (NOMINAL)} + 0.5V$ or $2.5V$ (whichever is greater), $C_{IN} = 1\mu F$, $C_{OUT} = 1\mu F$, $T_A = +25^\circ C$, unless otherwise noted.

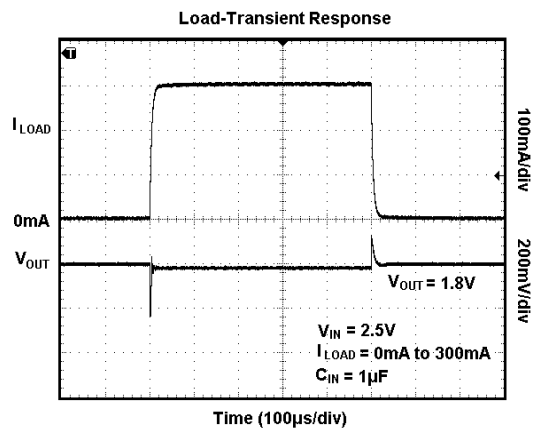
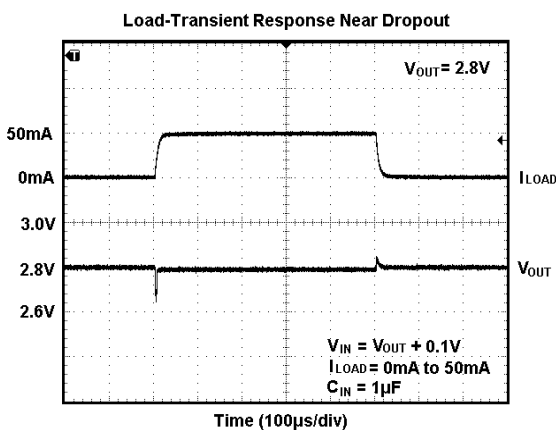
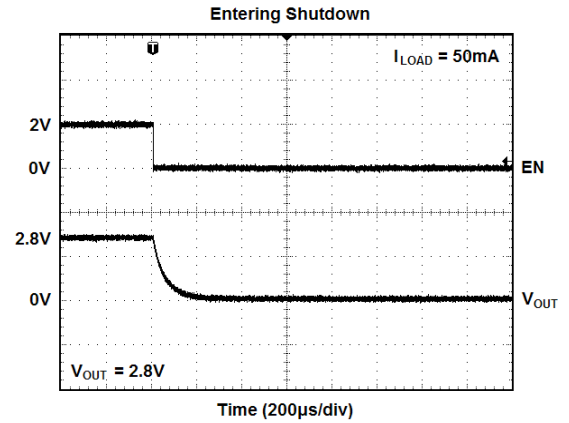
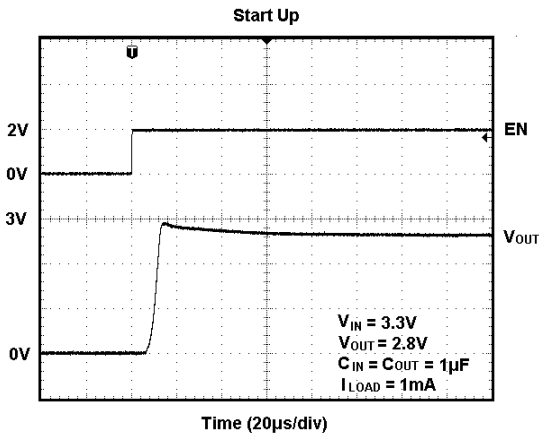
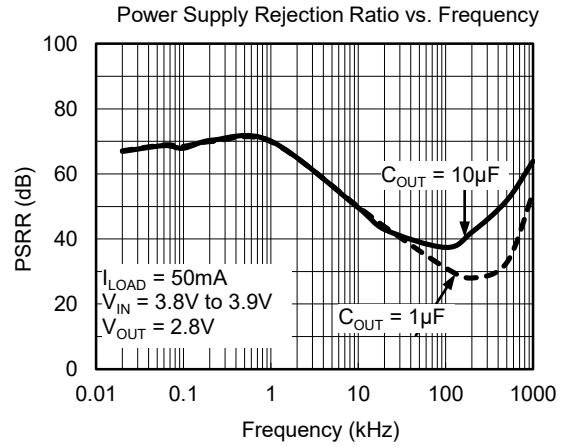
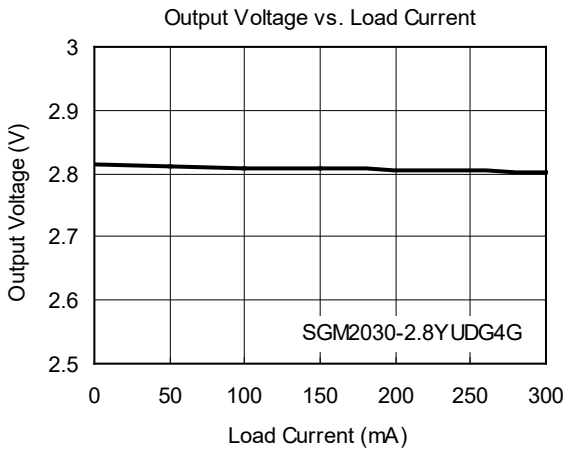

TYPICAL PERFORMANCE CHARACTERISTICS (continued)

$V_{IN} = V_{OUT (NOMINAL)} + 0.5V$ or $2.5V$ (whichever is greater), $C_{IN} = 1\mu F$, $C_{OUT} = 1\mu F$, $T_A = +25^\circ C$, unless otherwise noted.

Line-Transient Response

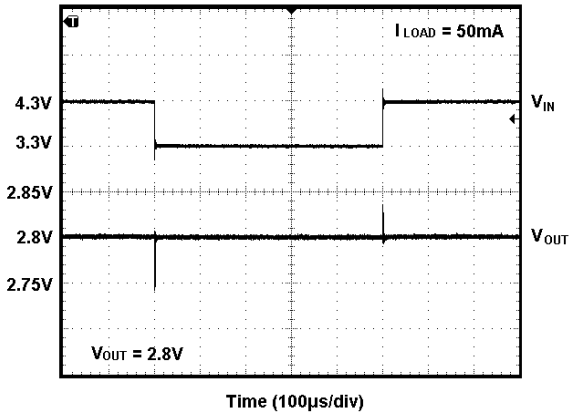

Shutdown Exit Delay

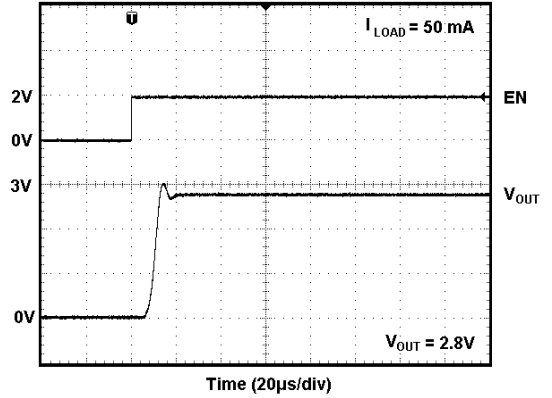

Output Noise 10Hz to 100kHz

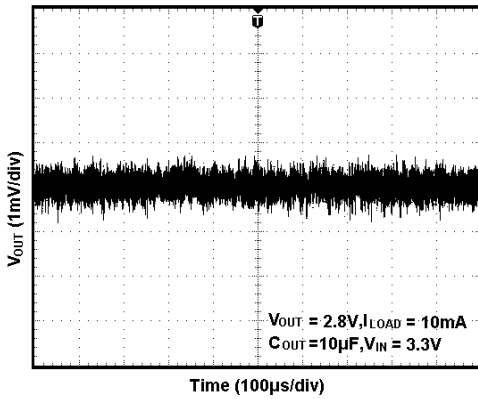

APPLICATION NOTE

When LDO is used in handheld products, attention must be paid to voltage spikes which could damage SGM2030. In such applications, voltage spikes will be generated at charger interface and V_{BUS} pin of USB interface when charger adapters and USB equipments are hot-plugged. Besides this, handheld products will be tested on the production line without battery. Test engineer will apply power from the connector pin which connects with positive pole of the battery. When external power supply is turned on suddenly, the voltage spikes will be generated at the battery connector. The voltage spikes will be very high, and it always exceeds the absolute maximum input voltage (6.0V) of LDO. In order to get robust design, design engineer needs to clear up this voltage spike. Zener diode is a cheap and effective solution to eliminate such voltage spike. For example, BZM55B5V6 is a 5.6V small package Zener diode which can be used to remove voltage spikes in cell phone designs. The schematic is shown below.

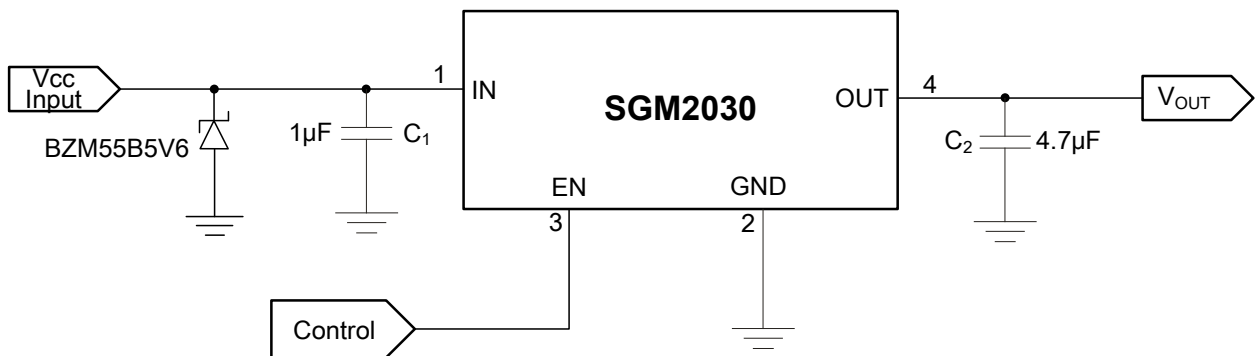

REVISION HISTORY

NOTE: Page numbers for previous revisions may differ from page numbers in the current version.

Revision	Page
MAY 2016 – REV.A.4 to REV.B	
Changed Normalized Output Voltage vs. Temperature	6
AUGUST 2014 – REV.A.3 to REV.A.4	
Changed TYPICAL PERFORMANCE CHARACTERISTICS section	7

PACKAGE OUTLINE DIMENSIONS

UTDFN-1.2×1.6-4L

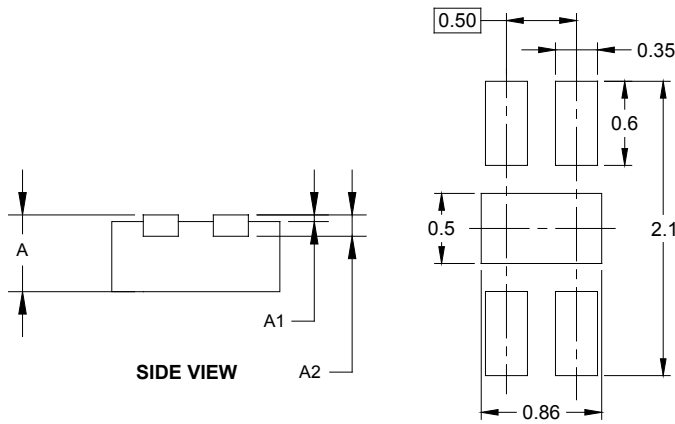
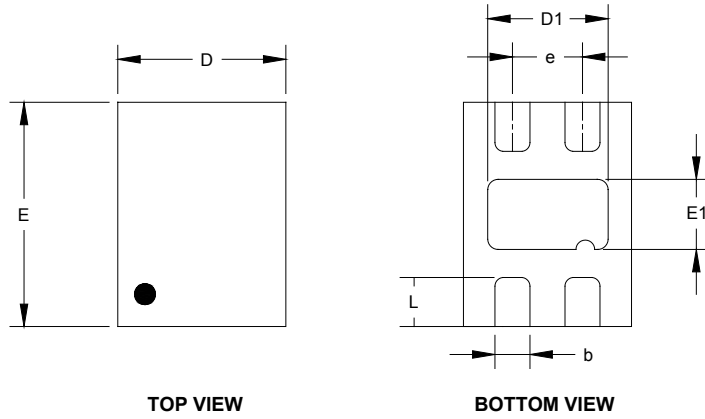

Symbol	Dimensions In Millimeters		
	MIN	MOD	MAX
A	0.500	0.550	0.600
A1	0.000		0.050
A2	0.152 REF		
D	1.150	1.200	1.250
D1	0.810	0.860	0.910
E	1.550	1.600	1.650
E1	0.450	0.500	0.550
b	0.200	0.250	0.300
e	0.500 BSC		
L	0.300	0.350	0.400

PACKAGE INFORMATION

TAPE AND REEL INFORMATION

REEL DIMENSIONS



TAPE DIMENSIONS



NOTE: The picture is only for reference. Please make the object as the standard.

KEY PARAMETER LIST OF TAPE AND REEL

Package Type	Reel Diameter	Reel Width W1 (mm)	A0 (mm)	B0 (mm)	K0 (mm)	P0 (mm)	P1 (mm)	P2 (mm)	W (mm)	Pin1 Quadrant
UTDFN-1.2×1.6-4L	7"	9.0	1.50	1.70	0.60	4.0	4.0	2.0	8.0	Q2

000001

PACKAGE INFORMATION

CARTON BOX DIMENSIONS



NOTE: The picture is only for reference. Please make the object as the standard.

KEY PARAMETER LIST OF CARTON BOX

Reel Type	Length (mm)	Width (mm)	Height (mm)	Pizza/Carton
7" (Option)	368	227	224	8
7"	442	410	224	18

DD0002